

Life Is On

Schneider
Electric

FUTURE



Daftar Harga 2024

se.com/id

Schneider Indonesia
berdiri sejak

1973 | 51
Tahun



Tahun 2019

Perusahaan yang paling
dikagumi di Dunia.

– dari Fortune, untuk Industri Elektronik

Pemimpin Industri

Dalam Indeks Dow Jones Sustainability (DJSI) selama 3 tahun berturut-turut dan "Industry Motver" untuk kemajuan proporsional terbaik pada performa keberlanjutannya dari tahun lalu.

Schneider
Electric

~137.000

Karyawan di 100+ Negara

♀ 30%
Karyawan kami
adalah wanita

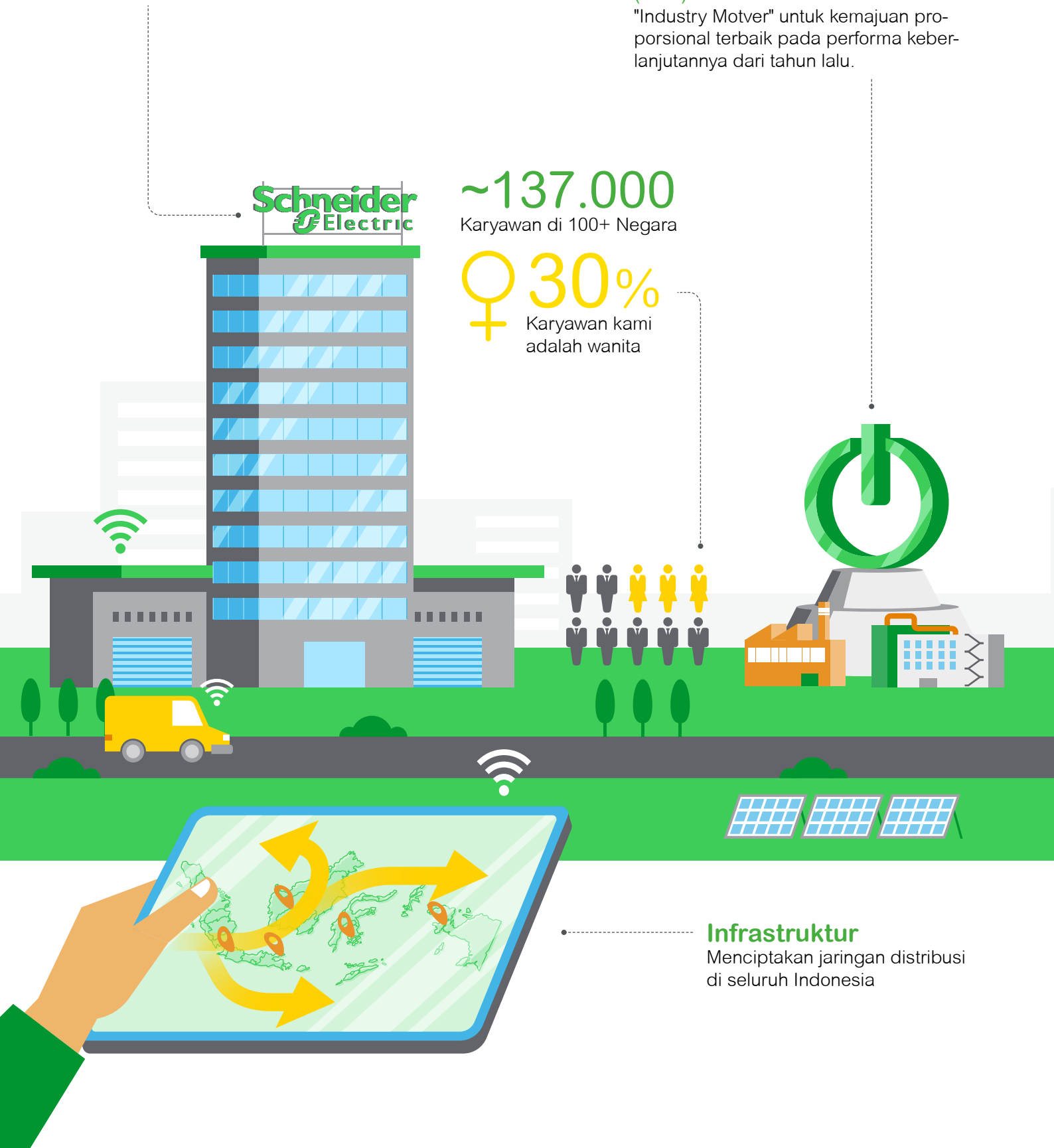

Infrastruktur

Menciptakan jaringan distribusi
di seluruh Indonesia

4 Bisnis yang Terintegrasi & Sinergis



40%
Building
Partner



29%
Industri



17%
Infra-
struktur



14%
Information
Technology

5%

dari Pendapatan
disalurkan untuk Riset
& Pengembangan

45%

Pendapatan
dari IoT

42%

Pendapatan dari
Ekonomi Baru

Sebagai **pemimpin global di transformasi digital** untuk manajemen energi dan otomasi, kami menciptakan teknologi terhubung yang



Membentuk
Kembali
Industri



Memperkaya
Hidup



Mengubah
Perkotaan



€26 Miliar
Pendapatan 2018

€3.9 Miliar
EBITDA yang disesuaikan 2018

Schneider Electric



SNI
AWARD
WINNER
SEJAK 2011

Standarisasi SNI
untuk Kotak Kontak



04-3892.1-2006

Standarisasi SNI
untuk Sakelar



04-6203.1-2006

Sakelar dan kotak kontak paling diminati
untuk proyek rumah tinggal



Syarat dan Ketentuan Harga 2024

- Harga belum termasuk PPN.
- Harga yang tercantum adalah harga satuan.
- Harga dan Status Stok dapat berubah sewaktu-waktu tanpa pemberitahuan terlebih dahulu.



Life Is On

Schneider
Electric

Daftar Isi

8

Indeks

1-1

Sakelar, Stop Kontak & Aksesori

2-1

Uninterruptible Power Supply (UPS)

3-1

Komponen Tegangan Menengah

4-1

Relay Proteksi Digital

5-1

Final Distribution Product

6-1

Moulded Case Circuit Breaker (MCCB)

7-1

Air Circuit Breaker (ACB)

8-1

Motor Starter & Sistem Proteksi Motor

9-1

Source-changeover systems

10-1

Koreksi Faktor Daya

11-1

Industrial Plug & Socket

12-1

Meter & Manajemen Energi

13-1

Panel Industri & Kontrol Temperatur

14-1

Sinyal & Kontrol

15-1

Relay & Power Supply

16-1

Soft Starter & Variable Speed Drive

Indeks

A

Aksesori	1-7
Kavacha	1-7
Wallbox dan Outbowdoost	1-7
Aksesori	5-21
Aksesori MCB, RCCB/ELCB iID, iDPN Vigi, iSW, RCA, ARA & Reflex	5-21
Altivar Building ATV212	16-12
Altivar 212 untuk Motor Induksi 0.75 - 75 kW	16-12
Altivar Machine ATV12	16-8
Altivar 12 untuk Motor Induksi 0.18 - 2.2 kW	16-8
Altivar Machine ATV320	16-9
Altivar 320 untuk Motor Induksi 0.37 - 15 kW	16-9
Pilihan dan Aksesori	16-10
Altivar Machine ATV340	16-11
Altivar 340 untuk Motor Induksi 0.37 - 15 kW	16-11
Pilihan dan Aksesori	16-11
Altivar Process ATV930	16-15
Altivar 930 untuk Motor Induksi 0.75 - 315 kW	16-15
Pilihan dan Aksesori	16-16
Altivar Process ATV630	16-13
Altivar 630 untuk Motor Induksi 0.75 - 160 kW	16-13
Pilihan dan Aksesori	16-14
Altivar Soft Starter ATS01	16-4
Soft Start/ Soft Stop untuk Motor 0.37 - 11 kW	16-4
Soft Start/ Soft Stop untuk Motor 0.75 - 15 kW	16-4
Altivar Soft Starter ATS22	16-5
Tegangan Tiga Phasa 230-440 VAC Koneksi ke Line Motor	16-5
Tegangan Tiga Phasa 230-440 VAC Koneksi ke Line Delta	16-5
Altivar Soft Starter ATS480	16-6
Memperkenalkan Generasi Terbaru Altivar Soft Starter ATS480	16-6
Tegangan tiga phasa 208-690 VAC Koneksi ke Line Motor	16-7
Tegangan tiga phasa 208-690 VAC Koneksi ke Terminal Delta	16-7
Automatic Transfer Switches	9-3

C

Cable End	13-18
Single Conductor (standard NF C 63-023)	13-18
Cam Switch Saklar Kendali dan Daya IP 40	14-22
Saklar OFF - ON	14-22
Saklar Alih	14-22
Command Control	5-25
Pengaman Peralatan Motor	5-25
PC Socket, Fuse Carrier, dan Pilot Lights	5-26
Acti 9 iTL Relay Impuls	5-27
Control Switches & Disconnection	5-28
Time Delay (iRT)	5-29
ComPact NS	6-39
ComPact NS800 - 1600 Manually Operated	6-39
ComPact NS800 - 1600 Electrically Operated	6-40
Aksesori ComPact NS800-1600A	6-41
ComPact NSX	6-25
ComPact NSX Direct access to Energy Efficiency	6-25
ComPact NSX100A - 250A dengan TMD	6-29
ComPact NSX100A - 630A dengan Micrologic	6-30
ComPact NSX untuk Proteksi Motor	6-31
ComPact NSX untuk Proteksi Distribusi - Arus Bocor	6-33
ComPact NSX untuk Proteksi DC Network	6-34
Aksesori ComPact NSX	6-35

ComPact NSXm	6-20
ComPact NSXm Introduction	6-20
ComPact NSXm 16 - 160A	6-21
ComPact NSXm Vigi 16 - 160A	6-23
Aksesori ComPact NSXm	6-24
Connection Devices	5-22
Busbar Sisir Horizontal 18 mm pitch	5-22
Current Transformer Solid Core	12-10
Dimensi CT	12-11
Current Transformer Split Core	12-12
Dimensi CT	12-13

D

Detuned Reactor	10-10
Detuned Reactor PowerLogic PFC & Asosiasi dengan Kapasitor PowerLogic PFC	10-10
Detuned Reactor EasyLogic PFC & Asosiasi dengan Kapasitor EasyLogic PFC	10-11
Digital Meter	12-15
Ampere Meter, Volt Meter, dan Frekuensi Meter Digital	12-15
Digital Meter dan Power Meter	12-16
Digital Meter Seri DM6200H dan Power Meter Seri PM2000	12-16

E

Easy Altivar ATV310	16-17
Altivar 310 untuk Motor Induksi 0.37 - 22 kW	16-17
Easy Altivar ATV610	16-18
Altivar 610 untuk Motor Induksi 0.75 - 160 kW	16-18
Easy Harmony ET6	15-26
Solusi HMI untuk aplikasi otomasi sederhana	15-26
Easy Harmony iPC	15-24
Industrial PC, Edge Box dan Display	15-24
Easy Harmony XA2 (diameter 22 mm)	14-4
Modular Push Button	14-4
Monolitik Pilot Lamp & Indikator	14-5
Easy Harmony XB2 (diameter 22 mm)	14-6
Overview	14-6
Karakteristik	14-7
Modular Push Button berbahan metal	14-8
Easy Lexium 18	15-45
Easy Lexium 18 range	15-45
Easy Lexium 18 servo drive and BCH18 motor combination	15-46
Easy Lexium 18 servo drives	15-47
Panduan Pemilihan, Dimensi & Berat, Deskripsi	15-47
Aksesori Koneksi	15-48
Braking resistor	15-49
Additional EMC input filters	15-50
Motor starters & Protection using class J fuses (UL certification)	15-51
Easy Lexium BCH18 servo motors	15-52
Presentasi & Deskripsi	15-52
Holding brake controller & Integrated encoder	15-52
Panduan Pemilihan	15-53
Dimensi & Berat	15-54
Connection components	15-55
Easy Proface ET6000	15-27
Solusi HMI untuk aplikasi otomasi sederhana	15-27
EasyPact™ CVS	6-9
EasyPact CVS Introduction	6-9
EasyPact CVS 100BS	6-10
EasyPact CVS 100A - 250A	6-11
EasyPact CVS 400A - 630A	6-12

M

MasterPact MTZ	7-13
MasterPact MTZ - Selection Guide, Introduction	7-13
MasterPact MTZ - Micrologic Trip Unit	7-15
MasterPact MTZ2/3 Tipe H1 + Micrologic 2.0X (Manually Operated)	7-16
MasterPact MTZ2/3 Tipe H1 + Micrologic 2.0X (Electrically Operated)	7-17
MasterPact MTZ2/3 Tipe H2 + Micrologic 2.0X (Manually Operated)	7-18
MasterPact MTZ2/3 Tipe H2 + Micrologic 2.0X (Electrically Operated)	7-19
Micrologic X Trip Unit & Digital Module (dirakit oleh PT Schneider Indonesia)	7-20
Aksesori (dirakit oleh PT Schneider Indonesia)	7-21
Aksesori (Spares) / dibeli terpisah	7-23
MCB Box Mini Pragma	5-19
Mini Pragma Pintu Transparan	5-19
Mini Pragma Pintu Biasa	5-19
Micro Data Center	2-8
Micro DC dengan UPS 1 Fasa 3 - 6kVA	2-8
Miniature Circuit Breaker (MCB)	5-3
Miniature Circuit Breaker (MCB) - Domae	5-3
RCCB / ELCB, MCB Box, dan Busbar Sisir - Domae	5-4
RCBO Slim dan Surge Arrester - Domae	5-5
Miniature Circuit Breaker (MCB) - Acti9 iK60A 4.5 kA	5-6
Miniature Circuit Breaker (MCB) - Acti9 iK60N 6 kA	5-7
Miniature Circuit Breaker (MCB) - Acti9 iC60N 6 kA	5-8
Miniature Circuit Breaker (MCB) - Acti9 iC60H-C 10 kA	5-9
Miniature Circuit Breaker (MCB) - Acti9 iC60H-D 10 kA	5-10
Miniature Circuit Breaker (MCB) - Acti9 iC60L 15 - 100kA	5-11
Miniature Circuit Breaker (MCB) - Acti9 C120N/H 10/15 kA	5-12
Miniature Circuit Breaker (MCB) - Acti9 C60H-DC	5-14
Mobile Plug	11-3
IP44	11-3
IP67	11-3
Mobile Socket	11-4
IP44	11-4
IP67	11-4
Modicon Easy M100	15-41
Logic Kontroler untuk aplikasi sederhana sampai dengan 40 I/O	15-42
Modicon Easy M200	15-43
Logic Kontroler untuk aplikasi sederhana sampai dengan 188 I/O	15-44
Modicon M221	15-28
Logic Kontroler & Book Logic Kontroler	15-29
Modicon M241	15-30
Logic Kontroler	15-31
Modicon M251	15-32
Logic Kontroler	15-33
Modicon M262	15-34
Logic Kontroler	15-34
Modicon TM3	15-36
Modicon TM3 Digital I/O modul	15-37
Modicon TM3 Analog I/O modul	15-38
Modicon TM3 Functional Safety Modul	15-39
Modicon TM3 Bus Expansion System	15-40

P

Panduan Baca Referensi (Panel Industri & Kontrol Temperatur)	13-3
Panel Kendali	14-23
Panel Kendali XAL Tipe Plastik	14-23
Panel Kendali Terpasang	14-23
Panel Kendali Kosong (Plastik)	14-23
Blok Kontak	14-23
Panel Kendali XAP Tipe Metal	14-24
Panel Kendali Kosong (Metal)	14-24

Panel Mounted Angled Socket	11-6
IP44	11-6
IP67	11-6
Panel Tembok (Wall Mounted)	13-7
Panel Spacial CRN (Bahan Besi)	13-7
Panel Thalassa PLM (Bahan Fiberglass-Reinforced Polyester)	13-8
Panel Spacial S3X (Bahan Stainless-steel)	13-9
Aksesori Panel Tembok (Wall Mounted)	13-10
Panorama Produk Altivar	16-3
Soft Starter & Variable Speed Drive	16-3
Pembaruan dalam TeSys	8-4
Pemutus Tenaga	10-14
Pengaman Arus Bocor	5-15
Acti9 RCCB / ELCB iID	5-15
RCBO iDPN N Vigi	5-16
Dikombinasikan dengan iC60 dan C120 - Modul Vigi	5-17
Penggunaan UPS pada Rumahan, Bangunan Komersial & Industrial	2-3
Aplikasi UPS pada Rumahan	2-3
Aplikasi UPS pada Bangunan Komersial & Industrial	2-3
Peralatan dan Koreksi Faktor Daya	10-3
Kegunaan dan Pembacaan Referensi	10-3
Cara Menghitung Daya Reaktif	10-4
Tabel Cos ϕ	10-5
Petunjuk Pemilihan Motor Starter Direct On Line	8-46
Koordinasi Tipe 1 (performa standard)	8-46
Koordinasi Tipe 2 (performa tinggi)	8-47
Petunjuk Pemilihan Motor Starter Direct On Line (Easy TeSys)	8-44
Koordinasi Tipe 1 (performa standard)	8-44
Petunjuk Pemilihan Motor Starter Star Delta	8-48
Koordinasi Tipe 1 (performa standard)	8-48
Koordinasi Tipe 2 (performa tinggi)	8-49
Petunjuk Pemilihan Motor Starter Star Delta (Easy TeSys)	8-45
Koordinasi Tipe 1 (performa standard)	8-45
Power Meter	12-17
Power Meter Seri PM5000 & PM8000	12-17
Power Meter Seri ION9000	12-18
Power Supply	15-20
Phaseo ABL2 - Panel Mounting Phaseo	15-20
Modicon ABLM & ABLS & ABL8 - DIN Rail Mounting	15-21
Modular, Optimum, & Universal	15-22
PowerLogic Protection Relay Range	4-3
PowerTag	12-3
PowerTag Acti9 & PowerTag NSX	12-3
PowerTag Flex 160A & PowerTag Rope	12-4
Tabel Seleksi PowerTag 63 A	12-5
Tabel Seleksi PowerTag Flex 160 A	12-7
Tabel Seleksi PowerTag NSX	12-8
Tabel Seleksi PowerTag Rope	12-9
Proteksi Arus Bocor Bumi	6-46
Vigirex dan Toroida	6-46

R

Regulator dan Kelengkapan	10-12
Relay Proteksi Arc Flash - PowerLogic Arc	4-11
PowerLogic Arc Unit, Sensor, dan Aksesoris	4-12
Relay Proteksi PowerLogic P1	4-4
Relay Proteksi PowerLogic P3	4-5
Deskripsi Produk	4-5
Model & Filter, Software, Aplikasi	4-6
PowerLogic P3 Universal dan Aksesoris	4-7
Relay Proteksi PowerLogic P3 Advance	4-8
Deskripsi Produk	4-8
Panduan Pemilihan Produk	4-9
PowerLogic P3 Advance, Modul Tambahan, dan Aksesoris	4-10

S			
S-Classic	1-4		
Design Tak Lakang Waktu	1-4		
S56 Kotak Kontak	11-8		
S56 Kotak Kontak	11-8		
S56 Kotak Kontak dengan Sakelar	11-8		
S56 Kotak Kontak RCD dan Tusuk Kontak	11-9		
S56 Kotak Kontak RCD	11-9		
S56 Tusuk Kontak	11-9		
S56 Sakelar	11-7		
S56 Sakelar	11-7		
Sistem Kontrol Temperatur Panel	13-13		
Sistem Pemanas Panel	13-12		
Sistem Ventilasi Panel	13-11		
Smart Panel	7-28		
Introduction	7-28		
Enerlin'X	7-30		
Source Changeover System (COS)	6-42		
Source Changeover System NSX100 - NSX630	6-42		
Source Changeover System NS800 - NS1600	6-43		
Source Changeover System (COS)	7-27		
Automatic Source Changeover (Masterpact MTZ)	7-27		
Standard dan Sertifikasi Panel Schneider	13-5		
Surge Arrester	5-23		
Surge Arrester Tipe 1 dan Tipe 1 + 2	5-23		
Surge Arrester Tipe 2 (Fixed Type)	5-24		
Surge Arrester Tipe 2 (Draw out)	5-24		
Cartridge untuk tipe iPRD	5-24		
Surge Arrester PRI	5-25		
Switch Disconnecter	6-44		
ComPacT NSX-NA, NS-NA, INS	6-44		
Aksesori ComPact INS	6-45		
T			
TeSys Active - TeSys island	8-41		
Panorama Produk TeSys island	8-41		
TeSys island - Sistem Pengendalian / Proteksi / Pemantauan Motor	8-42		
TeSys Active - TeSys T	8-40		
Sistem Manajemen Motor	8-40		
TeSys Active - TeSys Ultra	8-39		
Motor Starter 1 Komponen Koordinasi Total	8-39		
TeSys Control - Kontaktor 3 Kutub	8-5		
TeSys Control Easy TeSys (6 - 630 A)	8-5		
TeSys K (6 -16 A)	8-6		
TeSys Deca (9 - 150 A)	8-7		
TeSys Deca Green (AC/DC) (9 - 80 A)	8-8		
TeSys Control - Kontaktor 4 Kutub	8-9		
TeSys Control Easy TeSys (6 - 95 A) (AC-1)	8-9		
TeSys Deca (20 - 125 A) (AC-1)	8-10		
Aksesori Kontaktor TeSys K & TeSys Deca	8-11		
TeSys Control - Relay Kontrol	8-37		
Relay Kontrol TeSys K & TeSys Deca	8-37		
TeSys Giga	8-14		
TeSys Control - Kontaktor Giga Tipe Standard	8-15		
TeSys Control - Kontaktor Giga Tipe Advanced	8-16		
TeSys Protect - Relay Beban Lebih Elektronik LR9G	8-17		
TeSys Power - Motor Circuit Breaker	8-24		
Tesys Power Deca - GV2 & GV3 (Proteksi Magnetik)	8-24		
Tesys Power Deca - GV2 & GV3 (Proteksi Magnetik Termal)	8-25		
Tesys Power Deca - GV4 (Proteksi Magnetik)	8-30		
Tesys Power Deca - GV4 (Proteksi Magnetik Termal)	8-31		
Tesys Power Giga - GV5 & GV6 (Panorama Produk)	8-32		
Tesys Power Giga - GV5 & GV6 (Proteksi Magnetik Termal)	8-33		
TeSys Protect - Electronic Over Current Relay (EOCR)	8-23		
		TeSys Protect - Relay Beban Lebih Termal	8-19
		Easy TeSys Protect LRE	8-19
		TeSys Protect LR2K	8-20
		TeSys Protect LRD	8-21
		Aksesori LRD	8-22
		Tipe XB4 Metal dan XB5 Plastik (Overview)	14-9
		Tower Light	14-25
		Tipe XVM Diameter 45 mm	14-25
		Tipe XVG Diameter 60 mm	14-25
		TransferPacT ATS	9-6
		TransferPact Automatic ATS	9-6
		TransferPact Active Automatic ATS	9-6
		TransferPact Automatic - Aksesori	9-7
U			
		Uninterruptible Power Supply (UPS) 1 Aksesori	2-6
		Aksesoris UPS 1 Fasa	2-6
		Colokan Anti Petir	2-6
		Automatic Voltage Regulator	2-6
		Uninterruptible Power Supply (UPS) 1 Fasa	2-4
		Back UPS 750 - 2200 VA	2-4
		Back UPS Connect 12V	2-4
		Back UPS Pro 650 - 1500 VA	2-4
		Smart UPS C 1000 - 1500 VA	2-4
		Smart UPS T 750 - 3000 VA	2-4
		Smart UPS X 750 - 3000 VA	2-4
		Easy UPS On-Line SRV	2-4
		Smart UPS On-Line RT	2-4
		Smart UPS RTG	2-4
		Uninterruptible Power Supply (UPS) 1 Fasa Lithium-Ion	2-5
		Smart UPS Line Interactive Li-Ion	2-5
		Easy UPS Online Li-Ion	2-5
		Smart UPS RT Li-Ion	2-5
		Smart UPS Ultra	2-5
		Uninterruptible Power Supply (UPS) 3 Fasa	2-7
		Easy UPS 3S 10 - 15 kVA	2-7
		Easy UPS 3M 60 - 200 kVA	2-7
		Easy UPS 3L 250 - 600 kVA	2-7
		Easy UPS 3-Phase Modular 50 - 250 kVA	2-7
		USB Charger Range	1-6
		USB Charger Type A	1-6
		USB Charger + International Socket	1-6
		USB Charger Type A + C	1-6
V			
		Vivace	1-5
		Modern, Stylish, Minimalis	1-5
W			
		Wall Mounted Socket	11-5
		IP44	11-5
		IP67	11-5
		WOTPC ATS	9-8
		WOTPC ATS - Overview	9-9
		WOTPC ATS	9-10
		WOTPC ATS - Aksesori	9-10
		WOTPC ATS - Spare Parts	9-10
Z			
		Zelio Logic	15-17
		Smart Relay SR2	15-17
		Smart Relay SR2 & SR3	15-18



Life Is On

Schneider
Electric

Sakelar, Stop Kontak & Aksesori

Leona	1-3
Sakelar untuk Semua Rumah	1-3
S-Classic	1-4
Design Tak Lekang Waktu	1-4
Vivace	1-5
Modern, Stylish, Minimalis	1-5
USB Charger Range	1-6
USB Charger Type A	1-6
USB Charger + International Socket	1-6
USB Charger Type A + C	1-6
Aksesori	1-7
Kavacha	1-7
Wallbox dan Outbowdoost	1-7

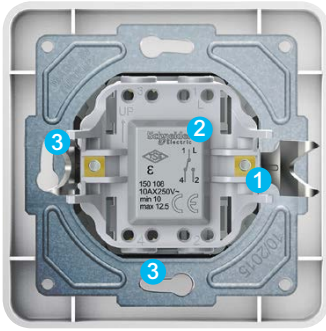

Cakar penahan yang kuat
Bagian pencakar yang optimal untuk pemasangan yang kuat.



Instruksi lengkap
Diagram perkabelan tercetak di bagian dalam produk.



Pemasangan yang mudah
Disesuaikan dengan kebutuhan Anda, pemasangan bisa dilakukan dengan sistem sekrup atau pencakar.

Leona Sakelar untuk Semua Rumah

■ Performa maksimal untuk rumah Anda

- Frame modul terbuat dari logam, menjamin kualitas, kekuatan, dan tahan lama.
- Cakar terlindungi, menjamin kekuatan dari daya cengkram pada inboard, sehingga bertahan lebih lama.
- Modul terbuat dari polycarbonate berkualitas. Lebih aman karena lebih tahan panas.



2 cara pemasangan mudah, sistem pencakar atau sekrup.



Konstruksi mekanikal kuat & tahan lama.



Desain stylish & minimalis.

Jenis	Referensi	Keterangan	Harga (Rp) (Sebelum PPN)
Sakelar	LNA0100321	10AX Sakelar 1 Gang - 1 Arah	19.300
	LNA0400321	10AX Sakelar 1 Gang - 2 Arah	24.800
	LNA0300321	10AX Sakelar 2 Gang - 1 Arah	23.600
	LNA0600321	10AX Sakelar 2 Gang - 2 Arah	36.400
	LNA2100321	10AX Sakelar 3 Gang - 1 Arah	39.900
	LNA0500321	10AX Sakelar Perantara (Intermediate)	64.500
Stop Kontak	LNA0800321	16AX 1 Gang Sakelar Bel dengan indikator	40.300
	LNA2900121	16A 1 Gang Kotak Kontak Tipe Schuko tanpa Child Protection	19.300
	LNA2900221	16A 1 Gang Kotak Kontak Tipe Schuko dengan Child Protection	23.600
	LNA9100221	2 GANG SCHUKO CP	53.700
	LNA9000221	Frame Double dengan 1 Schuko CP + Kosong	31.400
	LNA9200221	Frame Triple dengan 1 Schuko CP + 2 Kosong	33.900
Stop Kontak Data, TV, Telepon	LNA3200121	Stop Kontak TV	51.100
	LNA4100121	Stop Kontak Telepon	53.200
	LNA4300121	Stop Kontak Data RJ45 Cat 5	67.700
	LNA4700121	Stop Kontak Data RJ45 Cat 6	84.000
Aksesori Hotel & Lainnya	LNA1900221	Energy Saver Card Hotel	216.900
	LNA4500121	2 Gang USB Charger Max 2.1a	271.000
	LNA5800221	2 Gang Universal Frame	9.600
	LNA5800321	3 Gang Universal Frame	12.100
	OBL838348	1 Gang Outbow Leona	12.000



S-Classic Design Tak Lengkang Waktu

■ Dipercaya lebih dari 40 tahun

Terbuat dari polycarbonate berkualitas, kuat, dan tahan banting.

**) Dahulu dikenal dengan merek Clipsal. Clipsal telah diakuisisi oleh Schneider Electric di tahun 2007*

Jenis	Referensi	Keterangan	No. Gambar	Harga (Rp) (Sebelum PPN)
Sakelar	E31_1_2AR_WE_G3	10AX Sakelar 1 Gang - 1 Arah	1	26.100
	E31_2_3A_WE_G3	10AX Sakelar 1 Gang - 2 Arah	1	32.000
	E32_1_2AR_WE_G3	10AX Sakelar 2 Gang - 1 Arah	2	43.100
	E32_2_3A_WE_G3	10AX Sakelar 2 Gang - 2 Arah	2	51.400
	E33_1_2AR_WE_G3	10AX Sakelar 3 Gang - 1 Arah	3	62.600
	E33_2_3A_WE_G3	10AX Sakelar 3 Gang - 2 Arah	3	70.900
	E34_1_2AR_WE_G3	10AX Sakelar 4 Gang - 1 Arah	4	83.500
	E35_1_2AR_WE_G3	10AX Sakelar 5 Gang - 1 Arah	5	127.800
	ET36_1_2AR_WE	10AX Sakelar 6 Gang - 1 Arah	6	155.400
Kotak Kontak	E426_16S_WE_G3	16A 1 Gang Kotak Kontak Tipe Schuko	7	34.900
	E15NR_WE	13A 1 Gang Kotak Kontak Dengan Sakelar & Lampu Indikator Neon	8	79.000
	E15NR_EP13_E238_B	Tusuk kontak, Kotak Kontak 13A dengan Neon & Outbowdoost	9	113.000
Plat Penutup	E31X	1 Gang Plat Penutup	10	23.100
Kotak Kontak Tv, Telepon Dan Data	E31TV75_WE_G12	1 Gang Kotak Kontak TV Koaksial, 75 Ohm	11	74.200
	ET01_4_WE	1 Gang 4 WIRE Telepon OUTLET - Putih	12	72.300
	DCEKYBRWPS1PSWT_WE	1 Gang Kotak Kontak Data Cat 5	13	102.100
	DC6KYBRWPS1PSWT_WE	1 Gang Kotak Kontak Data RJ45	13	106.000



E31_1_2AR_WE_G3
E31_2_3A_WE_G3



E32_1_2AR_WE_G3
E32_2_3A_WE_G3



E33_1_2AR_WE_G3
E33_2_3A_WE_G3



E34_1_2AR_WE_G3



E35_1_2AR_WE_G3



ET36_1_2AR_WE



E426_16S_WE_G3



E15NR_WE



E15NR_EP13_E238_B



E31X



E31TV75_WE_G12



ET01_4_WE
ET02_4_WE



DCEKYBRWPS1PSWT_WE
DC6KYBRWPS1PSWT_WE

*) Dahulu dikenal dengan merek Clipsal. Clipsal telah diakuisisi oleh Schneider Electric di tahun 2007

Jenis	Referensi	Keterangan	No. Gambar	Harga (Rp) (Sebelum PPN)
Sakelar	KB31_1_WE_G3	16AX 250V 1 Gang - 1 Arah	1	29.900
	KB31_WE_G3	16AX 250V 1 Gang - 2 Arah	1	38.000
	KB32_1_WE_G3	10A 250V 2 Gang - 1 Arah	2	46.900
	KB32_WE_G3	10A 250V 2 Gang - 2 Arah	2	59.400
	KB33_1_WE_G3	16AX 250V 3 Gang - 1 Arah	3	69.900
	KB33_WE_G3	16AX 250V 3 Gang - 2 Arah	3	74.900
	KB34S_1_WE_G3	10AX 250V 4 Gang - 1 Arah, WE	4	111.900
	KB31IA_WE	10AX 250V Sakelar Intermediate	5	105.300
Sakelar Ganda	KB31BPB	10A 250V 1 Gang Sakelar Bell	5	108.800
	KB31D20NE_WE	20A 250V DOUBLE POLE SWITCH W NEON+EARTH	-	85.100
Stop Kontak	KB426_16S_WE_G3	16A 1 Gang Kotak Kontak Tipe Schuko	6	44.700
	KB15N	13A 250V 1 Gang Kotak Kontak Sakelar Neon	7	92.600
	KB413S_C15329	13A 250V 1 Gang Kotak Kontak Universal 3 pin SKT_C15329	8	57.900
USB Charger	KB31USB_WE	1 x 2.1A USB Charger, WE	-	393.600
	KB32USB_WE	2 x 2.1A USB Charger, WE	-	819.400
	KB42616USB_WE	16A Int Socket with 2.1A USB, WE	-	471.700
	KB32ACQUSB_WE	21W Type A+C, PD+QC3.0 USB Charger, WE	-	826.600
Plat Penutup	KB30_WE	1 Gang Plat Penutup	9	28.500
Aksesori Bingkai	KB_21_WE	KB 2 GANG SURROUND WITH SCHNEIDER BRAND	10	21.500
	KB_31_WE	KB 3 GANG SURROUND WITH SCHNEIDER BRAND	11	25.400
	KB_41_WE	KB 4 GANG SURROUND WITH SCHNEIDER BRAND	12	40.200
Kotak Kontak Tv, Telepon Dan Data	KB31TS_WE	1 Gang Telepon Outlet Dengan Penutup	13	115.500
	KB32TS	2 Gang Telepon Outlet Dengan Penutup	14	105.200
	KB31TV-OS	1 Gang Kotak Kontak TV	15	111.800
	KB31RJ5E_WE	1 Gang Kotak Kontak Data Cat 5E Dengan Penutup	16	117.800
	KB31RJ6_WE	1 Gang Kotak Kontak Data Cat 6	17	149.800
	KB32TS_RJ5E	1 Gang Telp dengan penutup dan 1 Gang Data Cat 5E	18	209.900
Peredup Lampu	KB31RD250T_WE	10A, 240VAC Dimer, Light Control, Rotary	19	332.900
Fan Control	KB31RF250_WE	250VA 3 Gang Pengatur Kecepatan Kipas (Exhaust)	20	612.600
Aksesori Hotel	KB31EKT	Hotel Key Card	21	653.000
	KB31BD_C_WE	Do Not Disturb & Clean Up Room dengan Bell Press	22	155.800
	KB727V_WE	115/240V Shaver Unit	23	714.000

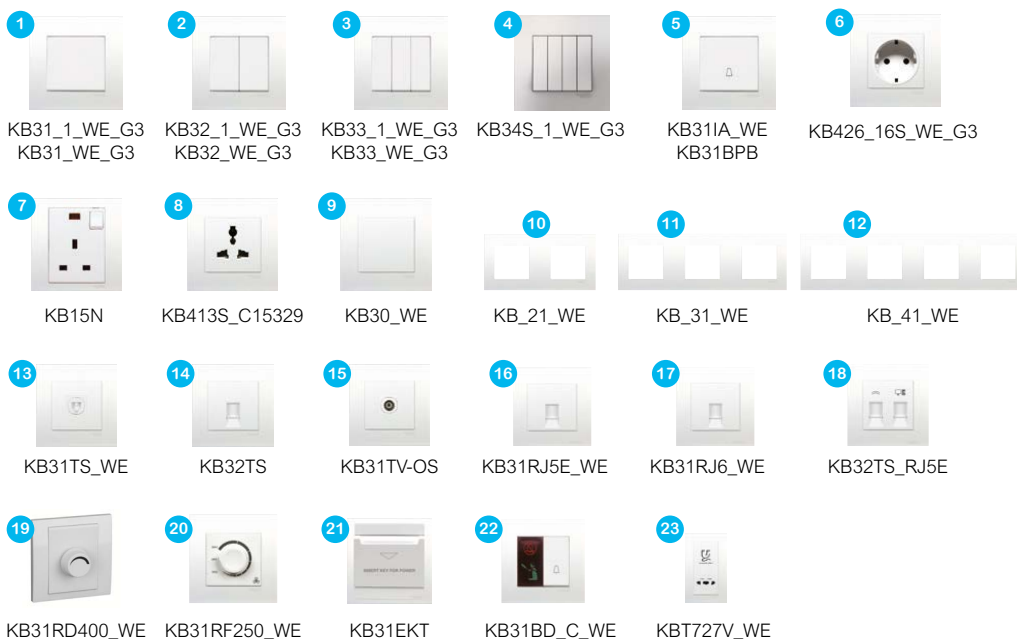

USB Charger Range

Vivace, Pieno, Zencelo, Neo, AvatarOn

■ Proses Charging Cepat

■ Energy Efficiency

■ Fitur Perlindungan

- Perlindungan terhadap panas berlebih.
- Perlindungan terhadap arus tidak stabil.
- Perlindungan terhadap tegangan tidak stabil.



KB31USB_WE



E8231USB_LS



E8332USB_WE



KB42616USB_WE



E8242616USB_WE

Jenis	Referensi	Family - Warna	Harga (Rp) (Sebelum PPN)
USB Charger Type A			
2.1 A Fast charging setiap Modulnya			
2 Gang USB Charger = 2 x 2.1Amp			
1 Gang USB Chargers 2.1A	KB31USB_WE	Vivace	393.600
	E8231USB_WE	Pieno, Putih	494.000
	E8231USB_LS	Pieno, Lavender Silver	544.100
	E8431USB_WE	Zencelo, Putih	699.900
	E8431USB_SZ	Zencelo, Silver Bronze	683.300
	E3031USB_WW	Neo, Putih	1.031.600
	E3031USB_GS	Neo, Grey Silver	778.500
2 Gang USB Chargers 2 x 2.1A	KB32USB_WE	Vivace	819.400
	E8232USB_WE	Pieno, Putih	979.000
	E8232USB_LS	Pieno, Lavender Silver	1.051.600
	E8432USB_SZ	Zencelo, Silver Bronze	1.274.300
	E8332USB_WE	AvatarOn, Putih	963.900
	E8332USB_WG	AvatarOn, Wine Gold	1.178.500
	E8332USB_DG	AvatarOn, Dark Grey	1.178.500
E8332USB_WD	AvatarOn, Dark Wood	1.342.700	
International Socket + 2.1 A USB			
International Socket + 2.1 A USB	KB42616USB_WE	Vivace	471.700
	E8242616USB_WE	Pieno, Putih	520.200
	E8242616USB_LS	Pieno, Lavender Silver	585.300
	E8342616USB_WE	AvatarOn, Putih	579.300
	E8342616USB_WG	AvatarOn, Wine Gold	666.200
	E8342616USB_DG	AvatarOn, Wine Gold	666.200
	E8342616USB_WD	AvatarOn, Dark Wood	765.100
Type A + C QC - 21 W Max			
The first and only Qualcomm listed wall-mounted QC USB in Qualcomm Quick Charge Technology Device List.			
When type A has completed the charging, type C will smartly switch into fast charge mode (Type C: 5V,3A)			
Type A + C QC - 21 W Max	KB32ACQUSB_WE	Vivace	826.600
	E8332ACQUSB_WE	AvatarOn, Putih	1.157.100
	E8332ACQUSB_WG	AvatarOn, Wine Gold	1.333.600
	E8332ACQUSB_WD	AvatarOn, Dark Wood	1.733.100

Aksesori Kavacha, Wallbox dan Outbowdoost

Aksesori

Jenis	Referensi	Keterangan	No. Gambar	Harga (Rp) (Sebelum PPN)
Kavacha	E223R_WE	Pelindung kotak kontak tahan cuaca, IP55, Putih	1	88.200
	E223R_TR	Pelindung kotak kontak tahan cuaca, IP55, Transparan	2	88.200
	A3031WBP_WE	Bel Pintu tahan cuaca dengan indikator LED, IP44, Putih	3	181.600
	EP13	3 pin Plug	4	54.800
Inbowdoost	SWB_727245	Wall Box, Black	5	4.300
Outbowdoost	E238	MOUNTING BOX W/O TERM	6	29.800
	E238_2	2 GANG SURFACE MOUNT POLYCARB WALLBOX	7	69.000
	ET238D	2-GAN DP MOUNT'G BOX	8	80.700
	OBL838348	OBL838348 Outbow for Leona	9	12.000

Catatan: Untuk contoh produk yang dapat digunakan pada Outbowdoost mengacu ke table berikut :

Outbowdoost	Contoh Produk yang dapat digunakan
E238	Single sakelar dan stop kontak selain range Leona
ET238D	Sakelar atau Shaver yang persegi panjang misal: ET36_1_2AR_WE / E82T727B_WE
E238_2	2 unit dari single sakelar dan/atau stop kontak
OBL838348	Untuk range Leona 1 single sakelar atau stop kontak



■ AvatarOn

Sakelar dengan personalisasi cover



Daftar harga Sakelar, Stop Kontak serta Aksesori lainnya silakan Scan QR Code atau melalui tautan di bawah ini:



https://bit.ly/pricebook_retail

■ ZENCelo

Sakelar dan kotak kontak datar pertama di dunia



■ Pieno

Kombinasi sempurna antara estetika dan performa





Life Is On

Schneider
Electric

Uninterruptible Power Supply (UPS)

Penggunaan UPS pada Rumahan, Bangunan Komersial & Industrial	2-3
Aplikasi UPS pada Rumahan	2-3
Aplikasi UPS pada Bangunan Komersial & Industrial	2-3
Uninterruptible Power Supply (UPS) 1 Fasa	2-4
Back UPS 750 - 2200 VA	2-4
Back UPS Connect 12V	2-4
Back UPS Pro 650 - 1500 VA	2-4
Smart UPS C 1000 - 1500 VA	2-4
Smart UPS T 750 - 3000 VA	2-4
Smart UPS X 750 - 3000 VA	2-4
Easy UPS On-Line SRV	2-4
Smart UPS On-Line RT	2-4
Smart UPS RTG	2-4
Uninterruptible Power Supply (UPS) 1 Fasa Lithium-Ion	2-5
Smart UPS Line Interactive Li-Ion	2-5
Easy UPS Online Li-Ion	2-5
Smart UPS RT Li-Ion	2-5
Smart UPS Ultra	2-5
Uninterruptible Power Supply (UPS) 1 Aksesori	2-6
Aksesoris UPS 1 Fasa	2-6
Colokan Anti Petir	2-6
Automatic Voltage Regulator	2-6
Uninterruptible Power Supply (UPS) 3 Fasa	2-7
Easy UPS 3S 10 - 15 kVA	2-7
Easy UPS 3M 60 - 200 kVA	2-7
Easy UPS 3L 250 - 600 kVA	2-7
Easy UPS 3-Phase Modular 50 - 250 kVA	2-7
Micro Data Center	2-8
Micro DC dengan UPS 1 Fasa 3 - 6kVA	2-8
Extended Warranty untuk 1 & 3 Fasa	2-9
Extended Warranty Uninterruptible Power Supply (UPS) 1 Fasa	2-10
Extended Warranty Uninterruptible Power Supply (UPS) 3 Fasa	2-11

Bisnis Anda adalah Bisnis Kami

Apapun bisnis anda: Manufaktur, jasa atau manajemen fasilitas-prioritas anda adalah menciptakan dan menjaga lingkungan kerja yang efisien, aman, dan nyaman bagi pekerja dan *customer* anda

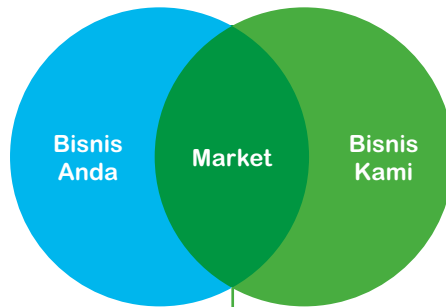

Kami menyediakan sistem manajemen daya global yang disesuaikan dengan kebutuhan spesifik di berbagai sektor.

Para ahli dan mitra proyek kami memiliki pengetahuan bisnis yang mendalam tentang setiap sektor yang kami layani di seluruh dunia.

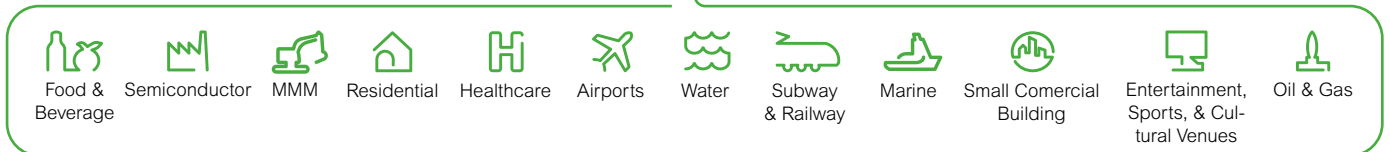

■ Aplikasi UPS pada Rumah

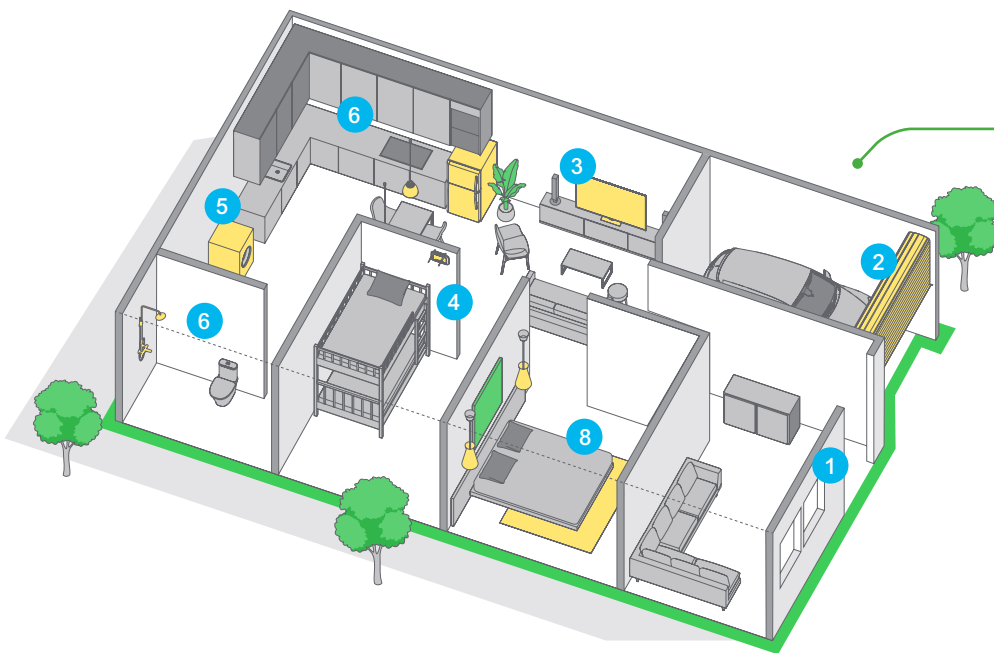

- 1 Motor untuk tirai.
- 2 Motor untuk pintu garasi.
- 3 Smart TV, Video Game, Home Theater, Audio System, CCTV, & Lampu.
- 4 Komputer, Laptop, Wifi Router, & Perangkat jaringan lainnya.
- 5 Mesin cuci, pencuci piring, kulkas.
- 6 Dapur, kamar mandi, & pompa toilet.
- 7 Pompa Basement, Pompa Kolam Renang, Pemurni Air, Automasi Rumah.
- 8 Alat Kesehatan.

■ Aplikasi UPS pada Bangunan Komersial & Industrial

- | | | |
|---|---|--|
| <p>Rumah Sakit</p> <ul style="list-style-type: none"> ▪ Alat-alat medis ▪ Ruang operasi & Pelayanan Pasien ▪ Radiologo, Tomografi & MRI ▪ Laboratorium | <p>Transportasi (Kereta, terowongan)</p> <ul style="list-style-type: none"> ▪ Automasi & Pengawasan Terintegrasi ▪ Lampu Sinyal ▪ Pusat Kontrol ▪ Automasi Bangunan ▪ Sistem Keamanan & Emergensi | <p>Bandara</p> <ul style="list-style-type: none"> ▪ Sistem Skringing & Akses Kontrol ▪ Lampu Landasan Pacu ▪ Menara Pengawasan Bandara |
| <p>Pembangkit Listrik</p> <ul style="list-style-type: none"> ▪ Sistem SCADA ▪ Ruang Kontrol ▪ Keamanan dan Pengawasan | <p>Gedung Kantor & Pabrik</p> <ul style="list-style-type: none"> ▪ Sistem keamanan, Akses Kontrol ▪ CCTV & Lampu Emergensi ▪ Manajemen Bangunan ▪ Lift ▪ IT Equipment & Data Center ▪ Penyiaran & Lab Komputer | <p>Pertambangan</p> <ul style="list-style-type: none"> ▪ SCADA & DCS ▪ Keamanan & Pengawasan ▪ Ruang Kontrol |
| <p>Industri Proses (Semiconductor)</p> <ul style="list-style-type: none"> ▪ Clean Room, HVAC ▪ Automasi Kritis Proses ▪ Sistem automasi untuk TFT, Plasma, LCD ▪ Proses Perangkaan & Pengujian | <p>Farmasi</p> <ul style="list-style-type: none"> ▪ Alat-alat Proses Kontrol Produksi ▪ Peralatan Pendukung Pabrik ▪ Ruang Kontrol ▪ Laboratorium | |



Scan untuk Spesifikasi Teknis



Back UPS



Smart UPS Line Interactive



Easy UPS SRV (Online)



Smart UPS RT (Online)



Smart-UPS RTG (SRTG)

Uninterruptible Power Supply

Melindungi perangkat elektronik anda dari gangguan listrik:

- Range **650VA - 20kVA**
- Cadangan baterai saat mati lampu
- Menstabilkan tegangan (stabilizer)
- Melindungi dari lonjakan tegangan
- Garansi UPS rusak ganti baru selama min. 2 tahun termasuk baterai
- Cocok untuk aplikasi IT ataupun non IT ([lihat halaman 2-3](#))

Sub Kategori	Daya Keluar	Back up time @half load	Back up time @full load	Referensi	Harga (Rp) (Sebelum PPN)	SS
Back UPS	12Watt/12VA			CP12010LI-GR	481.100	MTO
	410Watt/750VA	7.2 menit	0.4 menit	BX750MI-MS	3.032.500	MTS
	520Watt/950VA	6.2 menit	0.3 menit	BX950MI-MS	3.822.700	MTS
	650Watt/1.2kVA	6.5 menit	1.1 menit	BX1200MI-MS	4.393.800	MTS
	900Watt/1.6kVA	7.8 menit	1.6 menit	BX1600MI-MS	5.649.000	MTS
	1.2kWatt/2.2kVA	7.4 menit	1.2 menit	BX2200MI-MS	6.646.200	MTS
	360Watt/700VA	6 menit	0.1 menit	BVX700LUI-MS	1.383.100	MTS
	480Watt/900VA	6.5 menit	0.1 menit	BVX900LI-MS	2.092.300	MTS
Back UPS Pro	650Watt/1200VA	5 menit	0.8 menit	BVX1200LI-MS	2.929.200	MTS
	390Watt/650VA	10.5 menit	2.7 menit	BR650MI	4.448.900	MTS
	540Watt/900VA	16 menit	4.6 menit	BR900MI	6.689.200	MTS
	780Watt/1300VA	10.6 menit	2.1 menit	BR1300MI	11.045.900	MTS
Smart UPS C	960Watt/1600VA	10.4 menit	2.6 menit	BR1600MI	11.841.000	MTS
	600Watt/1000VA	22.5 menit	9.2 menit	SMC1000IC	11.218.800	MTS
	900Watt/1500VA	20.4 menit	9.8 menit	SMC1500IC	14.796.600	MTS
Smart UPS T	500Watt/750VA	15.5 menit	4.6 menit	SMT750IC	11.590.400	MTS
	700Watt/1000VA	19 menit	5.8 menit	SMT1000IC	16.364.700	MTS
	1000Watt/1500VA	23 menit	6.5 menit	SMT1500IC	22.491.000	MTS
	1980Watt/2200VA	25 menit	8.7 menit	SMT2200IC	35.865.300	MTS
	2700Watt/3000VA	17.2 menit	5 menit	SMT3000IC	45.208.000	MTS
Smart UPS X	600Watt/750VA	37.8 menit	14.2 menit	SMX750I	16.191.200	MTS
	800Watt/1000VA	24.2 menit	8.1 menit	SMX1000I	19.249.400	MTS
	1200Watt/1500VA	17.2 menit	5.8 menit	SMX1500RMI2U	30.661.600	MTS
Easy UPS SRV	2700Watt/3000VA	18 menit	6.3 menit	SMX3000RMHV2U	57.896.500	MTS
	800Watt/1000VA	10 menit	5 menit	SRV1KI	8.966.600	MTO
	1600Watt/2000VA	10 menit	5 menit	SRV2KI	18.741.400	MTO
	2400Watt/3000VA	10 menit	5 menit	SRV3KI	28.417.300	MTO
	6000Watt//6000VA	10 menit	3.5 menit	SRV6KI	54.572.000	MTS
Smart UPS RT	10000Watt//10000VA	7 menit	2 menit	SRV10KI	82.754.300	MTS
	700Watt/1000VA	32 menit	13.8 menit	SRT1000XLI	26.446.600	MTS
	1500Watt/1500VA	15.8 menit	4.6 menit	SRT1500XLI	28.099.800	MTS
	1980Watt/2200VA	11.6 menit	3.9 menit	SRT2200XLI	43.292.200	MTS
	2700Watt/3000VA	11.8 menit	4 menit	SRT3000XLI	60.999.400	MTS
	4500Watt/5000VA	11.8 menit	4 menit	SRT5KXLI	97.168.200	MTS
	6000Watt/6000VA	8.7 menit	2.5 menit	SRT6KXLI	106.975.500	MTS
	8000Watt/8000VA	14.5 menit	5.2 menit	SRT8KXLI	130.863.100	MTS
Smart UPS RTG	10000Watt/10000VA	11.5 menit	3.8 menit	SRT10KXLI	162.778.300	MTS
	5000Watt/5000VA	10.9 menit	2.8 menit	SRTG5KXLI	79.916.900	MTS
	6000Watt/6000VA	8.2 menit	1.5 menit	SRTG6KXLI	93.236.200	MTS
	8000Watt/8000VA	13.7 menit	4.9 menit	SRTG8KXLI	110.361.400	MTO
	10000Watt/10000VA	10.8 menit	3.5 menit	SRTG10KXLI	133.195.000	MTS
Smart-UPS RTG (SRTG)	15000Watt/15000VA	15.2 menit	5.6 menit	SRTG15KXLI	241.103.300	MTS
	20000Watt/20000VA	9.9 menit	3 menit	SRTG20KXLI	291.461.900	MTS

Catatan : Untuk custom kapasitas baterai (back up time), hubungi distributor resmi Schneider



Scan untuk Spesifikasi Teknis

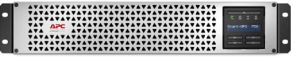

■ Uninterruptible Power Supply

Melindungi perangkat elektronik anda dari gangguan listrik:

- Range **500VA - 8kVA**
- Cadangan baterai saat mati lampu
- Menstabilkan tegangan (stabilizer)
- Melindungi dari lonjakan tegangan
- Garansi UPS rusak ganti baru selama 3-5 tahun termasuk baterai
- Cocok untuk aplikasi IT ataupun non IT (**lihat halaman 2-3**)

Sub Kategori	Daya Keluar	Back up time @half load	Back up time @full load	Referensi	Harga (Rp) (Sebelum PPN)	SS
Smart UPS Line Interactive Li-Ion (SMTL)	400Watt/500VA	6 menit	3 menit	SCL500RM1UC	13.822.900	MTO
	600Watt/750VA	13 menit	5.7 menit	SMTL750RM2UC	20.893.700	MTS
	800Watt/1000VA	16.7 menit	8 menit	SMTL1000RM2UC	30.411.500	MTS
	1350Watt/1500VA	13 menit	5 menit	SMTL1500RM3UC	39.605.800	MTS
	1980Watt/2200VA	17 menit	7.5 menit	SMTL2200RM2UC	52.682.100	MTS
Easy UPS Online Li-Ion (SRVL)	2700Watt/3000VA	12.5 menit	5 menit	SMTL3000RM2UC	58.776.300	MTS
	900Watt/1000VA	20 menit	10 menit	SRVL1KRIRK	26.528.800	MTS
	1800Watt/2000VA	20 menit	10 menit	SRVL2KRIRK	51.014.200	MTS
Smart UPS RT Li-Ion	2700Watt/3000VA	18 menit	9 menit	SRVL3KRIRK	58.156.400	MTO
	900Watt/1000VA	60.4 menit	31.6 menit	SRTL1000RMXLI	61.764.300	MTS
	1350Watt/1500VA	41.2 menit	21.3 menit	SRTL1500RMXLI	68.758.700	MTS
	1980Watt/2200VA	28 menit	14.3 menit	SRTL2200RMXLI	95.601.500	MTS
Smart UPS Ultra	2700Watt/3000VA	10.8 menit	10.5 menit	SRTL3000RMXLI	120.491.200	MTS
	2200Watt/2200VA	14 menit	6 menit	SRTL2K2RM1UIC	76.864.900	MTS
	3000Watt/3000VA	10 menit	4 menit	SRTL3KRM1UIC	83.659.300	MTS
	5000Watt/5000VA	12 menit	5 menit	SRTL5KRM2UI	146.387.700	MTS
	8000Watt/8000VA	15 menit	7 menit	SRTL8KRM4UI	284.390.000	MTS



Memudahkan Manajemen Aset

- 30-60% lebih ringan dibandingkan VRLA
- 10 tahun umur baterai & 5 tahun garansi baterai
- Meningkatkan performa pada suhu tinggi



Memaksimalkan Ruang Rak

- 30-50% pengurangan ukuran U
- 1U tiap tambahan *battery pack*
- Kompatibel dengan rak kedalaman pendek



Meningkatkan TCO

- 50% lebih hemat
- Mengurangi penggantian UPS & baterai
- Garansi lebih lama



Scan untuk Spesifikasi Teknis



Aksesori UPS 1 Fasa



Colokan Anti Petir



Automatic Voltage Regulator

Aksesoris Uninterruptible Power Supply (UPS) 1 Fasa, Automatic Voltage Regulator / Stabilizer & Colokan Anti Petir

Sub Kategori	Deskripsi	Referensi	Harga (Rp) (Sebelum PPN)	SS
Aksesori UPS 1 Fasa	Baterai Ekstrenal untuk SRT 1kVA	SRT48BP	17.031.300	MTS
	Baterai Ekstrenal untuk SRT 2.2kVA	SRT72BP	17.909.600	MTS
	Baterai Ekstrenal untuk SRT 3kVA	SRT96BP	22.995.200	MTS
	Baterai Ekstrenal untuk SRT 5kVA & 6kVA	SRT192BP	26.780.400	MTS
	Baterai Ekstrenal untuk SRT 8kVA & 10kVA	SRT192BP2	28.142.900	MTS
	Baterai Ekstrenal untuk SRTG (9 Ah)	SRTG192XLBP2	86.073.600	MTS
	Baterai Ekstrenal untuk SRTG (5 Ah)	SRTG192XLBP4	31.425.300	MTS
	Baterai Ekstrenal untuk BR1500MI	BR24BPG	4.903.500	MTS
	Network Management Card	AP9630	7.888.000	MTS
	Network Card untuk Easy UPS SRV	APV9601	4.215.500	MTS
	Rail Kit untuk SRT 1/1.5/2.2/3kVA	SRTRK4	6.857.700	MTS
	Rail Kit untuk SRT 5/6/8/10kVA	SRTRK2	5.870.700	MTS
	Rail Kit untuk SRTG 5/6/8/10/15/20kVA	SRTGRK1	3.365.900	MTS
	Rail Kit untuk Baterai Ekstrenal SRTG 15/20kVA	SRTGRK2	3.652.800	MTS
Terminal Kabel Anti Petir SNI	Terminal Kabel Schuko 1 lubang	PM1W-GR	373.600	MTO
	Terminal Kabel Schuko 5 lubang	PM5-GR	436.500	MTO
	Terminal Kabel Schuko 6 lubang	PM6-GR	779.400	MTO
	Terminal Kabel Schuko 8 lubang	PM8-GR	1.226.800	MTO
	Terminal Kabel Schuko 5 & USB 2 lubang	PM5U-GR	844.100	MTO
Automatic Voltage Regulator / Stabilizer	Automatic Voltage Regulator 250W/500VA	LSW500-IND	496.100	MTO
	Automatic Voltage Regulator 400W/800VA	LSW800-IND	736.800	MTO
	Automatic Voltage Regulator 250W/800VA	LSW1200-IND	816.000	MTO
	Automatic Voltage Regulator 250W/800VA	LSW2000-IND	1.065.200	MTO



Scan untuk Spesifikasi Teknis



Easy UPS 3S



Easy UPS 3M



Easy UPS 3L



Easy UPS 3-Phase Modular

Uninterruptible Power Supply

Melindungi perangkat elektronik anda dari gangguan listrik:

- Range **10kVA - 600kVA**
- Cadangan baterai saat mati lampu
- Menstabilkan tegangan (stabilizer)
- Melindungi dari lonjakan tegangan
- Garansi UPS selama 1 tahun
- Cocok untuk aplikasi IT ataupun non IT ([lihat halaman 2-3](#))

Sub Kategori	Daya Keluar	Back up time @full load	Referensi	Harga (Rp) (Sebelum PPN)	SS
Easy UPS 3S	10kWatt/10kVA	8.4 menit	E3SUPS10KHB	160.770.700	MTS
	10kWatt/10kVA	22.5 menit	E3SUPS10KHB	184.320.300	MTS
	15kWatt/15kVA	5 menit	E3SUPS15KHB	173.078.700	MTS
	15kWatt/15kVA	12.5 menit	E3SUPS15KHB	196.628.300	MTS
	20kWatt/10kVA	8.4 menit	E3SUPS20KHB	209.475.400	MTS
	20kWatt/10kVA	15 menit	E3SUPS20KHB	233.025.100	MTS
	30kWatt/10kVA	2.7 menit	E3SUPS30KHB	239.033.500	MTS
	30kWatt/10kVA	13 menit	E3SUPS30KHB	286.132.800	MTS
Easy UPS 3M	40kWatt/10kVA	5.2 menit	E3SUPS40KHB	287.389.400	MTS
	40kWatt/15kVA	8.4 menit	E3SUPS40KHB	310.939.000	MTS
	60kWatt/60kVA	5.9 menit	E3MUPS60KHS	444.587.000	MTS
	60kWatt/60kVA	16 menit	E3MUPS60KHS	520.102.000	MTS
	80kWatt/60kVA	6.9 menit	E3MUPS80KHS	527.604.000	MTO
	80kWatt/60kVA	14.5 menit	E3MUPS80KHS	580.976.000	MTO
	100kWatt/100kVA	7.5 menit	E3MUPS100KHS	615.626.000	MTS
	100kWatt/100kVA	12 menit	E3MUPS100KHS	643.522.000	MTS
Easy UPS 3L	120kWatt/120kVA	5.4 menit	E3MUPS120KHS	660.176.000	MTS
	120kWatt/120kVA	10.5 menit	E3MUPS120KHS	838.959.000	MTS
	160kWatt/160kVA	6.9 menit	E3MUPS160KHS	952.710.000	MTO
	160kWatt/160kVA	14.5 menit	E3MUPS160KHS	1.055.362.000	MTO
	200kWatt/200kVA	7.4 menit	E3MUPS200KHS	1.145.738.000	MTS
	200kWatt/200kVA	12 menit	E3MUPS200KHS	1.201.541.000	MTS
	250kWatt/250kVA	5 menit	E3LUPS250KHS	1.243.722.500	MTO
	250kWatt/250kVA	15 menit	E3LUPS250KHS	1.755.315.200	MTO
Easy UPS 3L	300kWatt/300kVA	5.6 menit	E3LUPS300KHS	1.515.117.100	MTO
	300kWatt/300kVA	16 menit	E3LUPS300KHS	1.927.310.600	MTO
	400kWatt/400kVA	7.4 menit	E3LUPS400KHS	2.141.595.000	MTO
	400kWatt/400kVA	13.5 menit	E3LUPS400KHS	2.530.635.900	MTO
	500kWatt/500kVA	6.7 menit	E3LUPS500KHS	2.427.892.400	MTO
	500kWatt/500kVA	13.5 menit	E3LUPS500KHS	3.052.757.400	MTO
	600kWatt/600kVA	7.4 menit	E3LUPS600KHS	3.268.719.200	MTO
	600kWatt/600kVA	10 menit	E3LUPS600KHS	3.332.671.800	MTO
Easy UPS 3-Phase Modular (Scalable up to 250kVA)	50kW/50kVA	8.8 menit	EMUPS50K250PBHS	647.119.000	MTS
	100kW/100kVA	8.3 menit	EMUPS50K250PBHS	833.646.000	MTS
	150kW/150kVA	6.4 menit	EMUPS50K250PBHS	1.002.276.000	MTS
	200kW/200kVA	8.3 menit	EMUPS50K250PBHS	1.423.345.000	MTS
	250kW/250kVA	5.8 menit	EMUPS50K250PBHS	1.581.448.000	MTS

Catatan :

- UPS sudah termasuk Network Management Card & Jasa Start Up.
- Belum termasuk biaya akomodasi teknisi untuk start up UPS diluar wilayah Jabodetabek.
- Untuk custom kapasitas UPS(KVA) & baterai (back up time), hubungi distributor resmi Schneider.

Micro Data Center

Micro DC dengan UPS 1 Fasa 3 - 6kVA

Micro Data Center

All-in-one IT Solution to optimize the edge, tersedia ukuran 24 / 42 / 43 U

- UPS range 3 - 6kVA, sudah dilengkapi PDU, Cooling 3.5kW dan sistem monitoring (optional)
- Cadangan baterai saat mati lampu
- Menstabilkan tegangan (stabilizer)
- Melindungi dari lonjakan tegangan
- Garansi UPS selama min. 2 tahun
- Cocok untuk aplikasi IT ataupun non IT (lihat halaman 2-3)

Better Protected



Emergency Fan akan menyala secara otomatis ketika terjadi kegagalan daya & kelembaban rendah.



Otomatis mendeteksi ketika udara luar terlalu panas dan menyalakan kembali unit cooling

More Efficient



Otomatis mematikan unit cooling dan hanya menggunakan ventilasi udara untuk menghemat energi ketika kondisi sesuai*

*Beban ≤ 1.2kW dan udara luar tidak terlalu panas

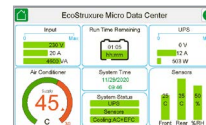
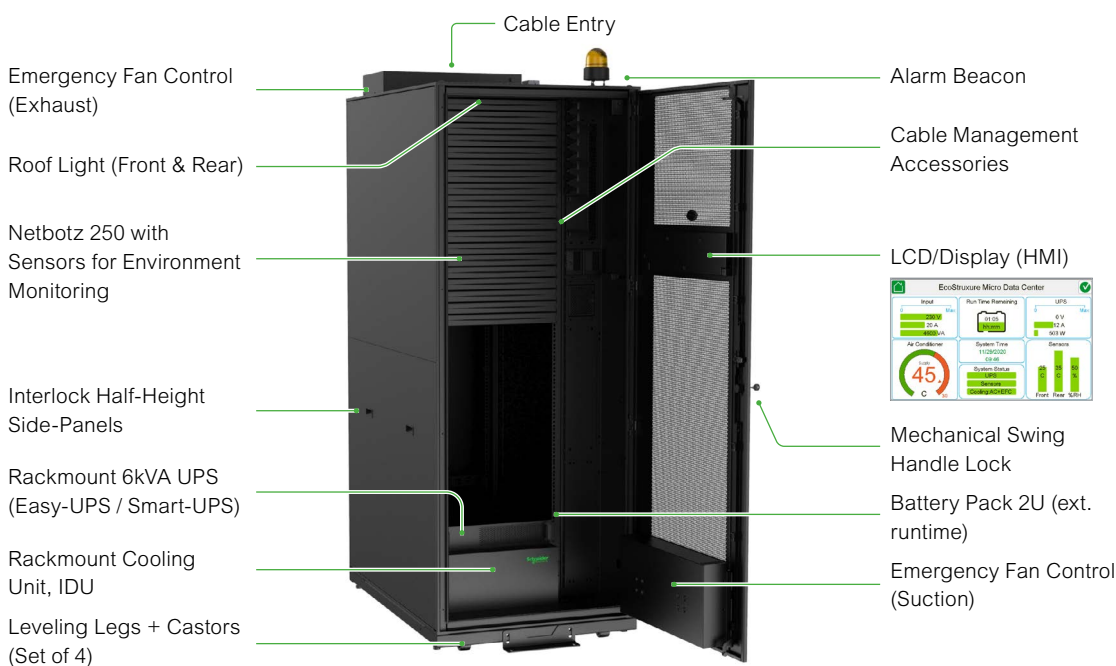

Sub Kategori	Daya Keluar	Back up time @full load	Input MCB	Uk. Kabel NYN	Referensi	Harga (Rp) (Sebelum PPN)	SS
EcoStruxure Micro DC 43U, Easy UPS 6 kVA extended runtime + Basic rPDU	3kW/6kVA	18 menit	63A	3x6mm	MDC43UECSI	283.552.000	MTS
EcoStruxure Micro DC 43U, Easy UPS 6 kVA extended runtime + Metered rPDU	3kW/6kVA	18 menit	63A	3x6mm	MDC43UBCSI	287.040.000	MTS
EcoStruxure Micro DC 43U, Smart UPS 6 kVA extended runtime + Basic rPDU	3kW/6kVA	18 menit	63A	3x6mm	MDC43USCSI	318.189.000	MTS
EcoStruxure Micro DC 43U, Smart UPS 6 kVA extended runtime + Metered rPDU	3kW/6kVA	18 menit	63A	3x6mm	MDC43UACSI	348.419.000	MTS

Catatan :

- Biaya sudah termasuk UPS, Cooling, PDU (Power Distribution Unit), MCB Input, Kabel Input, dan Jasa Instalasi
- Belum termasuk biaya akomodasi teknisi untuk start up UPS diluar wilayah Jabodetabek
- Untuk custom kapasitas UPS(KVA), baterai (back up time), dan sistem monitoring hubungi distributor resmi Schneider Electric



Save Money
Menghemat CapEx hingga 48%



Save Time
Deployment dalam hitungan minggu bukan bulan



Save Space
Solusi Lengkap data center dalam satu rak



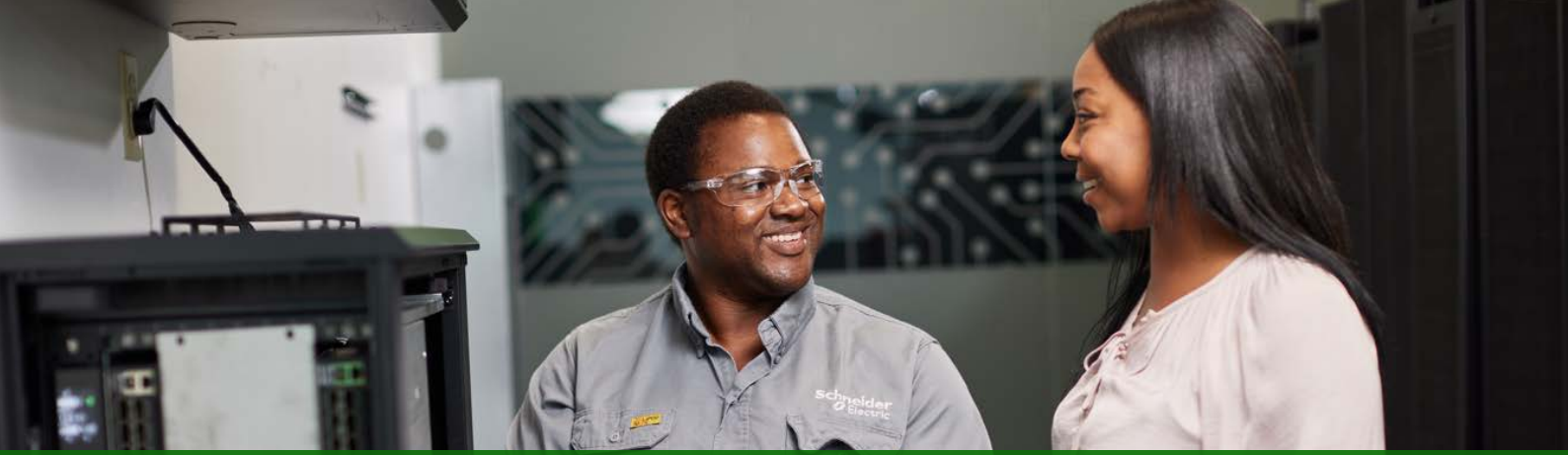

Simplify
Infrastruktur standar terintegrasi, dapat dimonitor dari mana saja





Extended Warranty untuk 1 & 3 Fasa Uninterruptible Power Supply (UPS)

Extended Warranty memperpanjang masa pakai produk, dengan memberikan cakupan perbaikan atau penggantian di luar garansi pabrik.

- 

Opsi Extended Warranty memungkinkan pelanggan untuk memilih paket yang paling sesuai dengan kebutuhan uniknya, sesuai dengan tingkat kekritisannya lokasi, arsitektur infrastruktur fisik, dan batasan anggaran.
- 

Pelanggan dapat memilih antara 1 tahun atau 3 tahun untuk 1 Fasa UPS & 1 tahun atau 2 tahun untuk 3 Fasa UPS.
- 

Semua paket termasuk dukungan teknis dengan teknisi dukungan khusus produk untuk membantu semua pertanyaan dan masalah.
- 

Untuk 1 Fasa UPS mencakup kerusakan baterai (hanya baterai internal) dan komitmen pengiriman suku cadang atau unit pada hari kerja berikutnya.

Fitur	Manfaat
Cakupan Produk	Memberikan kenyamanan dan perlindungan garansi pabrik yang lengkap untuk keseluruhan masa pakai produk yang ditentukan.
Layanan Pelanggan 24/7	Memberikan nomor bebas pulsa kepada pelanggan. Panggilan ditangani 24 jam sehari, 7 hari dalam seminggu oleh para profesional call center.
Layanan Bantuan dan Layanan Sertifikat Garansi	Membantu memastikan produk dicatat dengan benar. Hak Layanan Email Sertifikat memberikan catatan rinci tentang pendaftaran layanan, bersama dengan tanggal kedaluwarsa layanan.
Durasi Garansi	Menawarkan solusi biaya terendah untuk opsi perlindungan 1 tahun dan solusi dengan nilai terbaik untuk opsi 3 tahun (1 Fasa UPS)
	Menawarkan solusi biaya terendah untuk opsi perlindungan 1 tahun proteksi dan solusi dengan nilai terbaik untuk opsi 2 tahun (3 Fasa UPS)



Scan untuk Spesifikasi Teknis

Extended Warranty

Uninterruptible Power Supply (UPS) 1 Fasa
UPS Stabilizer 1 Fasa 0.65 - 20 kVA

Pelanggan dapat memilih perpanjangan warranty
1 tahun atau 3 tahun sesuai kebutuhannya

Sub Kategori	Referensi	1 Year Extended Warranty		3 Year Extended Warranty		
		Referensi	Harga (Rp) <i>(Sebelum PPN)</i>	Referensi	Harga (Rp) <i>(Sebelum PPN)</i>	
Back UPS	CP12010LI-GR BX750MI-MS BX950MI-MS BX1200MI-MS BX1600MI-MS BX2200MI-MS BVX700LUI-MS BVX900LI-MS BVX1200LI-MS	WEXT1YR-BU-01	299.000	WEXT3YR-BU-01	752.800	
	Back UPS Pro	BR650MI BR900MI BR1300MI BR1600MI				
		Easy UPS SRV	SRV1KI SRV2KI SRV3KI SRV6KI SRV10KI			
			Smart UPS C	SMC1000IC		
	Smart UPS T	SMT750IC SMT1000IC	WEXT1YR-SU-01	752.800	WEXT3YR-SU-01	1.862.700
	Smart UPS X	SMX750I SMX1000I				
	Smart UPS RT	SRT1000XLI				
Smart UPS RT Li-Ion	Smart UPS Line Interactive Li-Ion (SMTL)	SCL500RMI1UC SMTL750RMI2UC SMTL1000RMI2UC	WEXT1YR-SU-02	1.326.900	WEXT3YR-SU-02	3.368.100
	Smart UPS RT Li-Ion	SRTL1000RMXLI				
	Smart UPS C	SMC1500IC				
	Smart UPS T	SMT1500IC				
	Smart UPS X	SMX1500RMI2U				
	Smart UPS RT	SRT1500XLI SRT2200XLI				
	Smart UPS RT Li-Ion	Smart UPS Line Interactive Li-Ion (SMTL)				
Smart UPS RT Li-Ion		SRTL1500RMXLI				
Smart UPS Ultra		SRTL2K2RM1UIC				
Smart UPS T		SMT2200IC SMT3000IC				
Smart UPS X		SMX3000RMHV2U				
Smart UPS RT		SRT3000XLI				
Smart UPS Line Interactive Li-Ion (SMTL)		SMTL3000RMI2UC				
Smart UPS RT Li-Ion	SRTL2200RMXLI SRTL3000RMXLI	WEXT1YR-SU-05	5.154.200	WEXT3YR-SU-05	13.804.000	
	Smart UPS Ultra					SRTL3KRM1UIC
	Smart UPS RT					SRT5KXLI SRT6KXLI
Smart UPS RTG	SRTG5KXLI SRTG6KXLI	WEXT1YR-SU-06	7.042.400	WEXT3YR-SU-06	18.856.100	
	Smart UPS Ultra					SRTL5KRM2UI
	Smart UPS RT					SRT8KXLI SRT10KXLI
Smart UPS RTG	SRTG8KXLI SRTG10KXLI	WEXT1YR-SU-07	16.585.200	WEXT3YR-SU-07	44.780.000	
	Smart UPS Ultra					SRTL8KRM4UI
	Smart UPS RTG					SRTG15KXLI SRTG20KXLI
Easy UPS Online Li-Ion (SRVL)	SRVL1KRIRK	WEXTWAR1YR-SE-01	1.377.900	***		
	SRVL2KRIRK	WEXTWAR1YR-SE-02	1.939.200	***		
	SRVL3KRIRK	WEXTWAR1YR-SE-03	2.934.400	***		

Catatan :

- Extended warranty termasuk Battery dan Sparepart
- ***) Easy UPS online Li-Ion (SRVL) hanya bisa perpanjangan garansi untuk opsi maksimal 1 tahun
- Extended warranty tipe UPS lainnya silahkan menghubungi distributor resmi Schneider Electric



Scan untuk Spesifikasi Teknis

Extended Warranty

Uninterruptible Power Supply (UPS) 3 Fasa

UPS Stabilizer 3 Fasa 10 - 600 kVA

Pelanggan dapat memilih perpanjangan warranty 1 tahun atau 2 tahun sesuai kebutuhannya

Sub Kategori	Daya Keluar	Back up time @full load	Referensi	1 Year Extended Warranty		2 Year Extended Warranty					
				Referensi	Harga (Rp) (Sebelum PPN)	Referensi	Harga (Rp) (Sebelum PPN)				
Easy UPS 3S	10kWatt/10kVA	8.4 menit	E3SUPS10KHB	WOE1YR-EZ-15	9.160.200	WOE2YR-EZ-15	17.733.400				
	15kWatt/15kVA	5 menit	E3SUPS15KHB								
	20kWatt/10kVA	8.4 menit	E3SUPS20KHB								
	30kWatt/10kVA	2.7 menit	E3SUPS30KHB								
	40kWatt/10kVA	5.2 menit	E3SUPS40KHB								
Easy UPS 3M	60kWatt/60kVA	5.9 menit	E3MUPS60KHS	WOE1YR-EZ-60	15.437.000	WOE2YR-EZ-60	29.929.900				
	80kWatt/60kVA	6.9 menit	E3MUPS80KHS								
	100kWatt/100kVA	7.5 menit	E3MUPS100KHS								
	120kWatt/120kVA	5.4 menit	E3MUPS120KHS								
	160kWatt/160kVA	6.9 menit	E3MUPS160KHS								
Easy UPS 3L	200kWatt/200kVA	7.4 menit	E3MUPS200KHS	WOE1YR-EZ-200	21.382.200	WOE2YR-EZ-200	41.539.500				
	250kWatt/250kVA	5 menit	E3LUPS250KHS								
	300kWatt/300kVA	5.6 menit	E3LUPS300KHS								
	400kWatt/400kVA	7.4 menit	E3LUPS400KHS								
	500kWatt/500kVA	6.7 menit	E3LUPS500KHS								
Easy UPS 3-Phase Modular (Scalable up to 250kVA)	600kWatt/600kVA	7.4 menit	E3LUPS600KHS	WOE1YR-EZ-600	95.352.100	WOE2YR-EZ-600	184.937.600				
	50kW/50kVA	8.8 menit						WOE1YR-EM-50	13.497.800	WOE2YR-EM-50	21.178.000
	100kW/100kVA	8.3 menit						WOE1YR-EM-100	19.800.200	WOE2YR-EM-100	31.129.200
	150kW/150kVA	6.4 menit	EMUPS50K250PBHS					WOE1YR-EM-150	20.565.700	WOE2YR-EM-150	32.302.900
	200kW/200kVA	8.3 menit						WOE1YR-EM-200	24.086.800	WOE2YR-EM-200	37.839.800
	250kW/250kVA	5.8 menit		WOE1YR-EM-250	27.633.500	WOE2YR-EM-250	43.402.200				

Catatan :

- Battery UPS tidak termasuk dalam cakupan Extended Warranty
- Hanya berlaku untuk startup yang dilakukan oleh team Schneider Electric
- Free akomodasi untuk onsite engineer sampai dengan 70KM dari Jakarta & Surabaya office
- Extended warranty tipe UPS lainnya silahkan menghubungi distributor resmi Schneider Electric



Easy UPS 3S



Easy UPS 3M



Easy UPS 3L



Easy UPS 3-Phase Modular



Life Is On

Schneider
Electric

Komponen Tegangan Menengah

Komponen Tegangan Menengah	3-3
EvoPact HVX Embedded Pole 24kV Tipe Fixed	3-3
EvoPact HVX Embedded Pole 24kV Tipe Withdrawable	3-4
EasyPact EXE 12kV - Panduan Pemilihan	3-6
EasyPact EXE 12kV Tipe Fixed & Withdrawable	3-9
EasyPact EXE 12kV - Aksesori	3-10
Remote & Enhanced Control	3-10
LV Connection	3-11
Field Detectors & Locking	3-12
MV Connection	3-13



Scan untuk Data Pendukung



EvoPact HVX Embedded Pole 24kV Tipe Fixed

EvoPact HVX Embedded Pole 24kV Tipe Fixed

EvoPact HVX Embedded Pole merupakan pemutus arus tegangan menengah dengan pemutus berteknologi vakum yang digunakan dalam perakitan panel tegangan menengah.

Opening release, *closing release*, dan *charging motor* sudah termasuk dalam harga unit pemutus arus.

Referensi	Isc (kA)	Ir (A)	Phase Spacing (mm)	Harga (Rp) (Sebelum PPN)	SS
HVE242506F210F	25kA	630A	210mm	131.123.000	2 - MTO
HVE242506F275F	25kA	630A	275mm	134.423.000	2 - MTO
HVE242512F210F	25kA	1250A	210mm	136.027.000	2 - MTO
HVE242512F275F	25kA	1250A	275mm	139.452.000	2 - MTO
HVE242516F275F	25kA	1600A	275mm	204.969.000	2 - MTO
HVE242520F275F	25kA	2000A	275mm	228.702.000	2 - MTO
HVE242525F275F	25kA	2500A	275mm	236.217.000	2 - MTO
HVE243106F275F	31.5kA	630A	275mm	204.969.000	2 - MTO
HVE243112F275F	31.5kA	1250A	275mm	204.969.000	2 - MTO
HVE243116F275F	31.5kA	1600A	275mm	211.705.000	2 - MTO
HVE243120F275F	31.5kA	2000A	275mm	216.425.000	2 - MTO
HVE243125F275F	31.5kA	2500A	275mm	228.702.000	2 - MTO

Spesifikasi Standar

- Standard IEC62271-100
- Dimensional drawing: Standard
- Wiring diagram: Standard
- 58 pin plug
- Manual racking trolley
- Anti-pumping relay K01
- Opening release F11 110VDC
- Closing release F2 110VDC
- Charging motor M1 110VDC



Untuk tegangan *opening release*, *closing release*, dan *charging motor* di luar spesifikasi standar di atas, silakan hubungi kami.

Aksesori

Referensi	Deskripsi	Harga (Rp) (Sebelum PPN)	SS
AGSH30498-01	Charging Handle	1.175.000	2 - MTO
ASXN00151-01	58-pole LV Box Connector dengan female pin	1.991.000	2 - MTO

- Aksesori di atas wajib diorder saat membeli circuit breaker.
- Untuk spesifikasi di luar daftar harga, silakan hubungi kami.



Scan untuk Data Pendukung



EvoPact HVX Embedded Pole 24kV Tipe Withdrawable

EvoPact HVX Embedded Pole 24kV Tipe Withdrawable

EvoPact HVX Embedded Pole merupakan pemutus arus tegangan menengah dengan pemutus berteknologi vakum yang digunakan dalam perakitan panel tegangan menengah.

- Tipe withdrawable ini dapat dilengkapi dengan Cradle (L-Frame) yang terdapat dalam daftar harga.
- *Opening release*, *closing release*, dan *charging motor* sudah termasuk dalam harga unit pemutus arus.

Referensi	Isc (kA)	Ir (A)	Phase Spacing (mm)	Harga (Rp) (Sebelum PPN)	SS
HVE242506E210F	25kA	630A	210mm	168.585.000	2 - MTO
HVE242506E275F	25kA	630A	275mm	175.185.000	2 - MTO
HVE242512E210F	25kA	1250A	210mm	169.908.000	2 - MTO
HVE242512E275F	25kA	1250A	275mm	178.607.000	2 - MTO
HVE242516E275F	25kA	1600A	275mm	295.820.000	2 - MTO
HVE242520E275F	25kA	2000A	275mm	322.754.000	2 - MTO
HVE242525E275F	25kA	2500A	275mm	327.959.000	2 - MTO
HVE243106E275F	31.5kA	630A	275mm	264.289.000	2 - MTO
HVE243112E275F	31.5kA	1250A	275mm	268.553.000	2 - MTO
HVE243116E275F	31.5kA	1600A	275mm	300.591.000	2 - MTO
HVE243120E275F	31.5kA	2000A	275mm	325.402.000	2 - MTO
HVE243125E275F	31.5kA	2500A	275mm	333.165.000	2 - MTO

Spesifikasi Standar

- Standard IEC62271-100
- Dimensional drawing: Standard
- Wiring diagram: Standard
- Underneath earthing
- 58 pin plug
- Manual racking trolley
- Anti-pumping relay K01
- Opening release F11 110VDC
- Closing release F2 110VDC
- Charging motor M1 110VDC



Untuk tegangan *opening release*, *closing release*, dan *charging motor* di luar spesifikasi standar di atas, silakan hubungi kami.

Aksesori

Referensi	Deskripsi	Harga (Rp) (Sebelum PPN)	SS
CHD8000092R0114	Operating Handle Rack In/Out	874.000	2 - MTO
AGSH30498-01	Charging Handle	1.175.000	2 - MTO
ASXN00151-01	58-pole LV Box Connector with female pin	1.991.000	2 - MTO
CHD1000063P0005	Earthing Switch Handle	1.067.000	2 - MTO

- Aksesori di atas wajib diorder saat membeli circuit breaker.
- Untuk spesifikasi di luar daftar harga, silakan hubungi kami.



Cradle tanpa Earthing Switch



Cradle dengan Earthing Switch

EvoPact HVX Embedded Pole 24kV

Tipe Withdrawable

■ Cradle (L-Frame)

Cradle (L-Frame) tersedia dalam 2 (dua) referensi, tanpa Earthing Switch dan dengan Earthing Switch. Referensi cradle harus sesuai (kompatibel) dengan referensi unit pemutus arus EvoPact HVX Embedded Pole, mengacu pada tabel panduan pemilihan cradle.

Referensi	Harga (Rp) <i>(Sebelum PPN)</i>	SS
CHD8120075R0105	109.209.000	2 - MTO
CHD8120075R0137	102.305.000	2 - MTO
CHD8120075R0111	93.885.000	2 - MTO
CHD8120075R0146	114.077.000	2 - MTO
CHD8120075R0131	168.509.000	2 - MTO
CHD8120075R0118	168.509.000	2 - MTO
CHD8120075R0163	222.779.000	2 - MTO

■ Panduan Pemilihan Cradle

Referensi EvoPact HVX EP	Referensi Cradle (L-Frame)	
	Tanpa Earthing Switch	Dengan Earthing Switch
HVE242506E210F	CHD8120075R0105	CHD8120075R0137
HVE242506E275F	CHD8120075R0111	CHD8120075R0146
HVE242512E210F	CHD8120075R0105	CHD8120075R0137
HVE242512E275F	CHD8120075R0111	CHD8120075R0146
HVE242516E275F	CHD8120075R0131	Tidak tersedia
HVE242520E275F	CHD8120075R0131	Tidak tersedia
HVE242525E275F	CHD8120075R0118	CHD8120075R0163
HVE243106E275F	CHD8120075R0111	CHD8120075R0146
HVE243112E275F	CHD8120075R0111	CHD8120075R0146
HVE243116E275F	CHD8120075R0131	Tidak tersedia
HVE243120E275F	CHD8120075R0131	Tidak tersedia
HVE243125E275F	CHD8120075R0118	CHD8120075R0163



Scan untuk Data Pendukung

EasyPact EXE 12kV Tipe Fixed dan Withdrawable Panduan Pemilihan

■ EasyPact EXE 12kV Tipe Fixed & Withdrawable

EasyPact EXE merupakan pemutus arus tegangan menengah dengan pemutus berteknologi vakum yang digunakan dalam perakitan panel tegangan menengah. Tersedia dalam bentuk kit dimana basic function dan Aksesori nya dapat dirakit oleh pengguna sesuai kebutuhan.

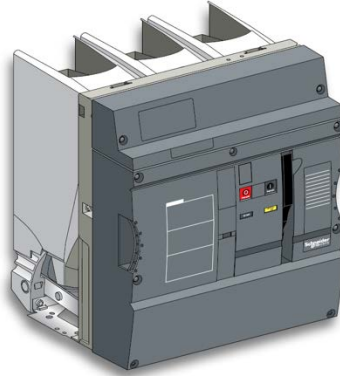

EasyPact 12kV Tipe Fixed

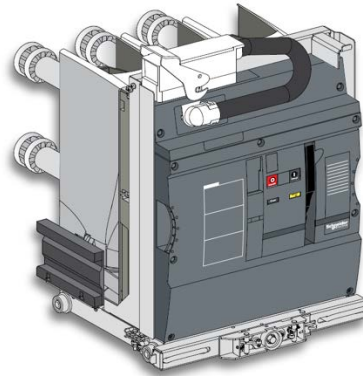

EasyPact 12kV Tipe Withdrawable

■ Panduan Pemilihan (Basic Function)

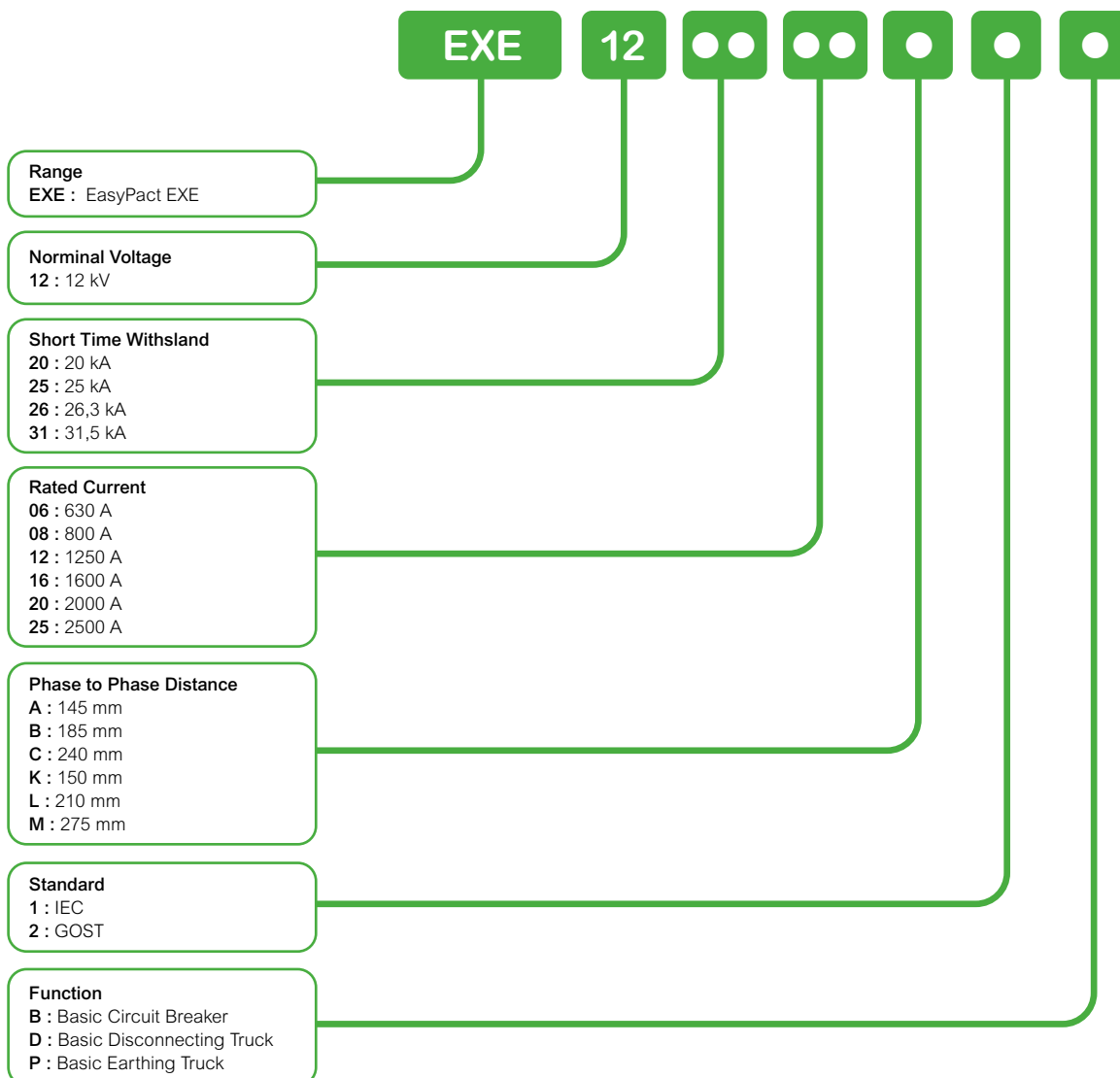

EasyPact EXE 12kV Tipe Fixed

Panduan Pemilihan

Panduan Pemilihan

Accessories and Auxiliaries

- The basic function can be customized with kits.
- The available kits for accessories and auxiliaries are shown below.

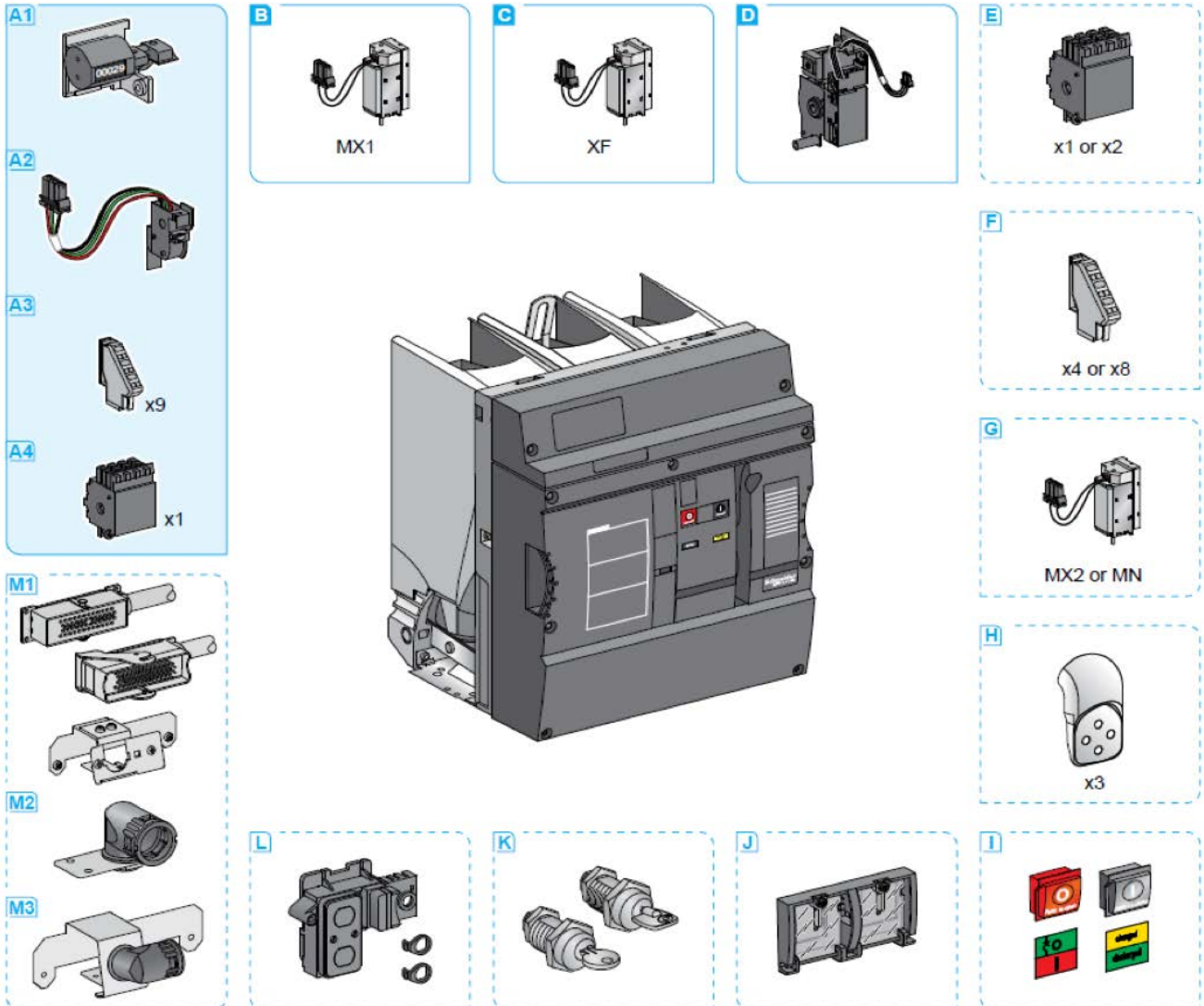

Factory-fitted

Mandatory solution

Preferred solution

- A1 Operation counter
- A2 "Ready to close" contact PF
- A3 LV Terminal blocks
- A4 1 Block 4 NO/NC Contacts
- B Opening release MX1
- C Closing release XF
- D Electrical motor MCH
- E Additional block 4 NO/NC Contacts
- F LV Terminal Block
- G Additional opening release MX2 or MN

- H Field deflectors, only for circuit breaker $I_r \leq 1250$ A
- I Label Kit for Pushbutton for GOST
- J Pushbutton Padlocking Device
- K Keylocks (for flat or cylindrical key)
- L Padlocking Device Open Position

LV auxiliary connection

- M1 LV 58 pin Plug (Male & Female)
- M2 LV Connection Elbow Right
- M3 LV Connection Elbow Left

Panduan Pemilihan Accessories and Auxiliaries

- The basic function can be customized with kits.
- The available kits for accessories and auxiliaries are shown below.

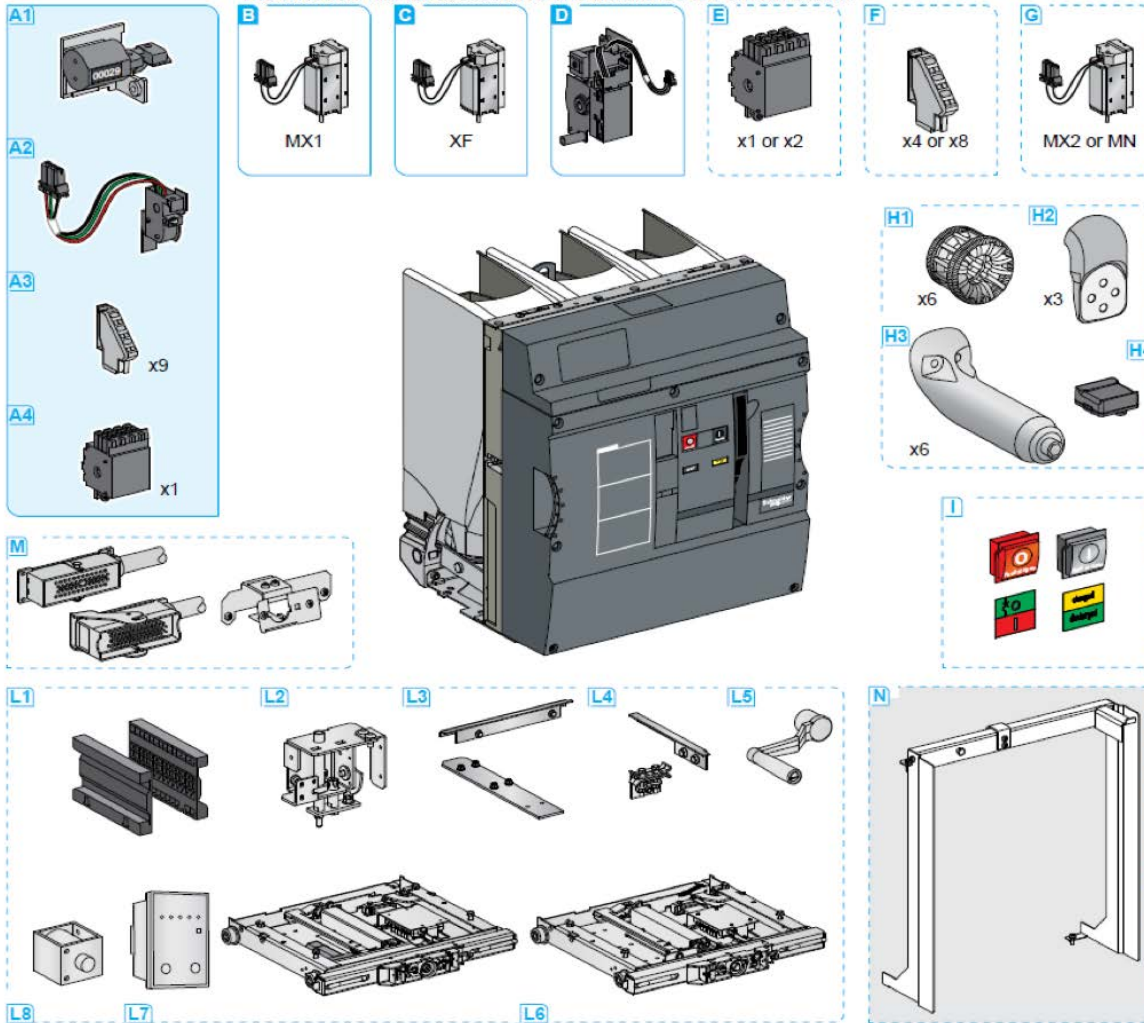

Factory-fitted
 Mandatory solution
 Preferred solution
 Partner scope

- A1 Operation counter
- A2 "Ready to close" contact PF
- A3 LV Terminal blocks
- A4 1 Block 4 NO/NC Contacts
- B Opening release MX1
- C Closing release XF
- D Electrical motor MCH
- E Additional block 4 NO/NC Contacts
- F LV Terminal Block
- G Additional opening release MX2 or MN

Power connections:

- H1 Clusters
- H2 Coated field deflectors
- H3 Arms
- H4 Thermal sensor kit TH110

GOST Standard:

- I Label Kit for Pushbutton

Racking Device:

- L1 Shutter ramps
- L2 Tripping
- L3 Bottom earthing & Earthing switch interlock
- L4 Side earthing & Earthing switch interlock
- L5 Racking handle
- L6 Racking trolley (manual)
- L7 Racking trolley (motorized) and Motor Controller kit
- L8 Locking Electromagnet

LV auxiliary connection:

- M LV 58-pin Plug (Male and Female)
- N IP Sheet in partner scope (SE will provide part drawings for typical cubicle width)



Scan untuk
Data Pendukung

EasyPact EXE 12kV Tipe Fixed & Withdrawable Basic Function & Cradle

EasyPact EXE 12kV Tipe Fixed - Basic Function

Referensi	Isc (kA)	Ir (A)	Phase Spacing (mm)	Harga (Rp) (Sebelum PPN)	SS
EXE122006B1B	20	630	185	99.573.000	2 - MTO
EXE122008B1B	20	800	185	99.573.000	2 - MTO
EXE122012B1B	20	1250	185	111.094.000	2 - MTO
EXE122006L1B	20	630	210	102.098.000	2 - MTO
EXE122008L1B	20	800	210	99.696.000	2 - MTO
EXE122012L1B	20	1250	210	111.156.000	2 - MTO
EXE122506B1B	25	630	185	100.448.000	2 - MTO
EXE122508B1B	25	800	185	100.448.000	2 - MTO
EXE122512B1B	25	1250	185	112.004.000	2 - MTO
EXE122506L1B	25	630	210	100.322.000	2 - MTO
EXE122508L1B	25	800	210	100.322.000	2 - MTO
EXE122512L1B	25	1250	210	111.777.000	2 - MTO
EXE122516L1B	25	1600	210	117.084.000	2 - MTO
EXE122520L1B	25	2000	210	128.520.000	2 - MTO
EXE122525L1B	25	2500	210	128.520.000	2 - MTO
EXE122525C1B	25	2500	245	128.520.000	2 - MTO
EXE123108B1B	31,5	800	185	110.559.000	2 - MTO
EXE123112B1B	31,5	1250	185	114.788.000	2 - MTO
EXE123108L1B	31,5	800	210	110.636.000	2 - MTO
EXE123112L1B	31,5	1250	210	117.833.000	2 - MTO
EXE123116L1B	31,5	1600	210	125.519.000	2 - MTO
EXE123120L1B	31,5	2000	210	128.520.000	2 - MTO
EXE123125L1B	31,5	2500	210	128.520.000	2 - MTO
EXE123125C1B	31,5	2500	245	128.520.000	2 - MTO

Basic Function di atas wajib dilengkapi dengan Aksesori:

- Electrical Motor (MCH), Opening Release (MX), Closing Release (XF) [lihat halaman 3-10](#)
- LV 58 pins Connector (Male & Female) untuk Fixed VCB [lihat halaman 3-11](#)
- Aksesori lainnya [lihat halaman 3-12](#)

EasyPact EXE 12kV Tipe Withdrawable - Basic Function

Referensi	Isc (kA)	Ir (A)	Phase Spacing (mm)	Harga (Rp) (Sebelum PPN)	SS
EXE122012K1B	20	1250	150	97.009.000	2 - MTO
EXE122512K1B	25	1250	150	102.073.000	2 - MTO
EXE123112K1B	31,5	1250	150	106.066.000	2 - MTO
EXE122006L1B	20	630	210	102.098.000	2 - MTO
EXE122506L1B	25	630	210	100.322.000	2 - MTO
EXE122012L1B	20	1250	210	111.156.000	2 - MTO
EXE122512L1B	25	1250	210	111.777.000	2 - MTO
EXE123112L1B	31,5	1250	210	117.833.000	2 - MTO
EXE122516L1B	25	1600	210	117.084.000	2 - MTO
EXE123116L1B	31,5	1600	210	125.519.000	2 - MTO
EXE122520L1B	25	2000	210	128.520.000	2 - MTO
EXE123120L1B	31,5	2000	210	128.520.000	2 - MTO
EXE122525M1B	25	2500	275	136.308.000	2 - MTO
EXE123125M1B	31,5	2500	275	137.602.000	2 - MTO

Basic Function di atas wajib dilengkapi dengan Aksesori:

- Electrical Motor (MCH), Opening Release (MX), Closing Release (XF) [lihat halaman 3-10](#)
- LV 58 pins Connector (Male & Female) untuk Withdrawable VCB [lihat halaman 3-11](#)
- Arms, Tulip Cluster, dan Withdrawable Truck (Manual Racking Trolley, Rolling Base, Tripping Chain, Shutter Ramp, Crank) [lihat halaman 3-13](#)

Cradle (L-Frame) untuk EasyPact EXE 12kV Tipe Withdrawable

Cradle (L-Frame) untuk EasyPact EXE 12kV tipe withdrawable ini tersedia untuk Phase Spacing 150mm, 210mm, dan 275mm, baik tanpa Earthing Switch dan dengan Earthing Switch.

Untuk EasyPact EXE 630A, 210mm dapat menggunakan tipe Cradle 12-31-12 P210.

Tipe	Tanpa Earth Switch			Dengan Earth Switch		
	Referensi	Harga (Rp) (Sebelum PPN)	SS	Referensi	Harga (Rp) (Sebelum PPN)	SS
Cradle 12-31-12 P150	AVXN10478-16	80.298.000	2 - MTO	AVXN10478-01	103.884.000	2 - MTO
Cradle 12-31-12 P210	AVXN10478-17	82.906.000	2 - MTO	AVXN10478-12	110.000.000	2 - MTO
Cradle 12-31-16 P210	AVXN10478-18	126.568.000	2 - MTO	AVXN10478-13	181.368.000	2 - MTO
Cradle 12-31-20 P210	AVXN10478-18	126.568.000	2 - MTO	AVXN10478-13	181.368.000	2 - MTO
Cradle 12-31-25 P275	AVXN10478-19	166.295.000	2 - MTO	AVXN10478-14	310.219.000	2 - MTO

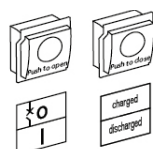
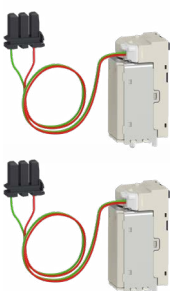
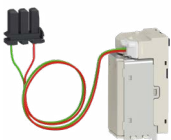

EasyPact EXE 12kV

Aksesori

Remote & Enhanced Control

Remote Control

Remoted Control	Tegangan	Referensi	Harga (Rp) (Sebelum PPN)	SS
Electrical Motor MCH		MCH		
DC	110-125 VDC	EXECH10D	3.235.000	2 - MTO
	220-250 VDC	EXECH20D	3.131.000	2 - MTO
AC 50/60 Hz	110-130 V 50/60 Hz	EXECH10A	3.282.000	2 - MTO
	220-240 V 50/60 Hz	EXECH20A	3.387.000	2 - MTO
Opening release MX or Closing release XF		MXF		
	48-60 VDC/48 VAC	59285	2.516.000	2 - MTO
	100-130 VDC/100-130 VAC	59286	2.597.000	2 - MTO
	200-250 VDC/200-250 VAC	59287	2.516.000	2 - MTO

Enhanced Control

Enhanced Control	Tegangan	Referensi	Harga (Rp) (Sebelum PPN)	SS
Opening release MX (2nd)		MX		
	48-60 VDC/48 VAC	59285	2.516.000	2 - MTO
	100-130 VDC/100-130 VAC	59286	2.597.000	2 - MTO
	200-250 VDC/200-250 VAC	59287	2.516.000	2 - MTO
Undervoltage release MN		MN		
	24-30 VDC/24 VAC	59288	2.516.000	2 - MTO
	48-60 VDC/48 VAC	59289	2.516.000	2 - MTO
	100-130 VDC/100-130 VAC	59290	3.763.000	2 - MTO
Second and third block of 4 NO/NC Auxiliary Contacts				
	4 NO/NC Auxiliary C A - 240V (max 2 blocs)	EXE47887	876.000	2 - MTO

Various

Various	Referensi	Harga (Rp) (Sebelum PPN)	SS
Labels Kit for push button and indicator			
Labels Kit for push button and indicator (O/C) (green / red)	EXELBPB	4.587.000	2 - MTO
LV Terminal block			
Auxiliary Terminal Block 3-Wire	EXE47074	644.000	2 - MTO



EasyPact EXE 12kV

Aksesori

LV Connection

■ LV Connection with Plug

LV Connection with Plug	Referensi	Harga (Rp) (Sebelum PPN)	SS
VCB LV 58 pins Connector (Male & Female) for FIXED VCB			
LV 58 pins Connector (Male & Female) for FIXED VCB	EXPLWB	5.358.000	2 - MTO
VCB LV 58 pins Connector (Male & Female) for Withdrawable VCB			
LV 58 pins Connector (Male & Female) for Withdrawable VCB	EXPLWB	6.133.000	2 - MTO

■ Elbow for LV Connection

Elbow for LV Connection	Referensi	Harga (Rp) (Sebelum PPN)	SS
Elbow			
LV Connection Elbow Right	EXEELR	3.294.000	2 - MTO
LV Connection Elbow Left	EXEELL	7.311.000	2 - MTO



EasyPact EXE 12kV Tipe Fixed

Aksesori

Field Detectors & Locking

■ MV Connection

MV Connection	Referensi	Harga (Rp) (Sebelum PPN)	SS
Field Deflector			
Set of 3 Field Deflectors			
Field Deflectors up to 1250 A (optional for fixed version)	EXEFLDF	3.684.000	2 - MTO

■ Fixed Accessories (Locking, Interlocking)

Fixed Accessories (Locking, Interlocking)	Referensi	Harga (Rp) (Sebelum PPN)	SS
Padlocking Device			
Locking of the circuit breaker in the open position by padlock (key locks not supplied)	EXE48541	1.144.000	2 - MTO
Locking of the circuit breaker in the open position by keylocks			
Flat Key	1 Key Lock + 2 Flat Keys	41940	2 - MTO
	2 Key Locks + 1 Flat Key ⁽¹⁾	41950	2 - MTO
Cylindrical	1 Key Lock + 2 Cylindrical Keys	42888	2 - MTO
	2 Key Locks + 1 Cylindrical Key ⁽¹⁾	42878	2 - MTO
Push Button Padlock			
Disabling of O/C circuit breaker buttons (Padlock not supplied)	48536	921.000	2 - MTO

Catatan:

⁽¹⁾ One keylock mounted on the breaker, + one identical keylock supplied separately for interlocking with another device.

■ Locking Accessories for Withdrawable Type

Locking Accessories for Withdrawable Type	Referensi	Harga (Rp) (Sebelum PPN)	SS
Racking Device Locking Magnet 24 V DC - V AC	EXETR2LKMA02	2.205.000	2 - MTO
Racking Device Locking Magnet 48 V DC - V AC	EXETR2LKMA04	2.205.000	2 - MTO
Racking Device Locking Magnet 110 V DC - V AC	EXETR2LKMA10	2.205.000	2 - MTO
Racking Device Locking Magnet 220 V DC - V AC	EXETR2LKMA20	2.205.000	2 - MTO

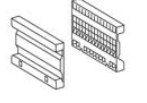

EasyPact EXE 12kV Tipe Withdrawable Aksesori

MV Connection

MV connections for Circuit Breaker

MV connections for Circuit Breaker	Referensi	Harga (Rp) (Sebelum PPN)	SS
Arms and Tulip Cluster for 150 or 210 or 275 mm phase distance			
Set of 3 Arms non Insulated			
MV Arms 630A Not Insulated for Tulip cluster	630 A	EXEARM06B	7.432.000 2 - MTO
MV Arms 800A-1250A Not Insulated for Tulip cluster	800-1250 A	EXEARM12B	7.329.000 2 - MTO
MV Arms 1600A-2000A Not Insulated for Tulip cluster	1600-2000 A	EXEARM20B	11.088.000 2 - MTO
MV Arms 2500A Not Insulated for Tulip cluster	2500 A	EXEARM25B	14.462.000 2 - MTO
Set of 3 Arms Insulated			
MV Arms 630A Insulated for Tulip cluster with Up = 95 kV	630 A	EXEARM06B1	10.440.000 2 - MTO
MV Arms 800A-1250A Insulated for Tulip cluster with Up = 95 kV	800-1250 A	EXEARM12B1	10.500.000 2 - MTO
Set of 6 Tulip Cluster			
MV Clusters Tulip 630A-800A-1250A	1250 A	EXECLU12B	6.744.000 2 - MTO
MV Clusters Tulip 1600A-2000A	2000 A	EXECLU20B	17.442.000 2 - MTO
MV Clusters Tulip 2500A	2500 A	EXECLU25B	24.036.000 2 - MTO

Withdrawable truck

Withdrawable truck	Referensi	Harga (Rp) (Sebelum PPN)	SS
Manual Racking Trolley for 150 or 210 or 275 mm phase distance and 200 mm stroke			
Racking Trolley 150mm Stroke 200 mm manual	EXETRKKB2	9.710.000	2 - MTO
Racking Trolley 210mm Stroke 200 mm manual	EXETRKL2	11.409.000	2 - MTO
Racking Trolley 275mm Stroke 200 mm manual	EXETRKM2	18.141.000	2 - MTO
Racking Trolley Earthing			
Racking Trolley Bottom Earthing	EXETRECB2	9.710.000	2 - MTO
Racking Trolley Side Earthing	EXETRECB1	9.983.000	2 - MTO
Racking Trolley Base			
Racking Trolley Base Phase Distance 210 mm Stroke 200 mm CD 310 mm	EXETRPBL	8.691.000	2 - MTO
Racking Trolley Base Phase Distance 275 mm Stroke 200 mm CD 310 mm	EXETRPBM	8.830.000	2 - MTO
Tripping chain for Withdrawable VCB			
Trolley Tripping Component \leq 1250 A	EXETRIP5	1.444.000	2 - MTO
Trolley Tripping Component \geq 1250 A	EXETRIP6	2.187.000	2 - MTO
Shutter Ramp			
Shutter Ramp CD 205 mm 1250 A	EXESH5	2.110.000	2 - MTO
Shutter Ramp CD 310 \geq 1600 A	EXESH2	1.673.000	2 - MTO
Rack-in / rack-out crank			
Truck Operating shaft	EXESHFT2	1.698.000	2 - MTO



Schneider
Electric

MCset

PowerLogic Protection Relay Range	4-3
Relay Proteksi PowerLogic P1	4-4
Relay Proteksi PowerLogic P3	4-5
Deskripsi Produk	4-5
Model & Fitur, Software, Aplikasi	4-6
PowerLogic P3 Universal dan Aksesories	4-7
Relay Proteksi PowerLogic P3 Advance	4-8
Deskripsi Produk	4-8
Panduan Pemilihan Produk	4-9
PowerLogic P3 Advance, Modul Tambahan, dan Aksesoris	4-10
Relay Proteksi Arc Flash - PowerLogic Arc	4-11
PowerLogic Arc Unit, Sensor, dan Aksesoris	4-12

BARU

Tingkatkan **KEAMANAN** jaringan listrik ke level berikutnya bersama relay proteksi **PowerLogic™**



Tingkatkan Sistem Keamanan

Fitur yang lengkap untuk meningkatkan safety dan reliability



Digitalisasi Jaringan Listrik

Pengalaman digital untuk efisiensi operasional



Efisiensi Operasi & Maintenance

Sederhanakan proses instalasi, konfigurasi, dan maintenance. Efisiensi secara waktu serta anggaran investasi dan operasional



Brand relay proteksi **PowerLogic** merupakan **rebranding** dari lini produk relay proteksi yang sebelumnya dikenal dengan brand **Easergy**

Relay Proteksi PowerLogic P1



■ Relay Proteksi PowerLogic P1

Produk PowerLogic P1 merupakan relay proteksi fungsi dasar bagian dari grup relay proteksi PowerLogic P range, melengkapi product PowerLogic P3 dan P5.

PowerLogic P1

Simple, easy-to-use, reliable and safe protection relays

- PowerLogic P1 adalah relay proteksi dengan dimensi yang kompak, yang memiliki fungsi proteksi arus atau proteksi tegangan (tetapi tidak keduanya).
- PowerLogic P1 adalah solusi yang andal dan aman untuk aplikasi sederhana seperti arus berlebih (Overcurrent), gangguan arus pada instrumen pentanahan (Ground Fault), tegangan, dan frekuensi.
- Dengan dimensinya yang relatif kecil, sangat cocok digunakan untuk aplikasi distribusi dasar di gedung komersial dan industri, pengaturan industri atau utilitas distribusi atau sebagai aplikasi Tegangan Rendah/ Low Voltage (LV) saat fungsi standar ANSI (American National Standards Institute) diperlukan.
- PowerLogic P1 menggunakan software konfigurasi yang sama dengan PowerLogic P3 yaitu software eSetup Easergy Pro.

■ P1F - Feeder Current Protection Relay

Model	Referensi	Power Supply Vx	Io Range	Vo	DI	DO	RS485	Front USB	Dist. Rec	Auto Reclose	Harga (Rp) (Sebelum PPN)	SS
Model L	REL15000	24-240 VAC/VDC	1A/5A ; 0.01-2 Ion	-	-	4	-	-	-	-	11.503.000	2
	REL15001	24-240 VAC/VDC	1A/5A ; 0.05-12Ion	-	-	4	-	-	-	-	11.503.000	2
Model L + RS	REL15002	24-240 VAC/VDC	1A/5A ; 0.01-2 Ion	-	-	4	Y	-	-	-	11.981.000	2
	REL15003	24-240 VAC/VDC	1A/5A ; 0.05-12Ion	-	-	4	Y	-	-	-	11.981.000	2
Model N	REL15004	24-240 VAC/VDC	1A/5A ; 0.01-2 Ion	-	-	6	Y	Y	-	-	13.010.000	2
	REL15005	24-240 VAC/VDC	1A/5A ; 0.05-12Ion	-	-	6	Y	Y	-	-	13.010.000	2
Model B	REL15006	24-60 VAC/VDC	1A/5A ; 0.01-2 Ion	-	4	4	Y	Y	-	-	13.419.000	2
	REL15007	90-240 VAC/VDC	1A/5A ; 0.01-2 Ion	-	4	4	Y	Y	-	-	13.419.000	2
	REL15008	24-60 VAC/VDC	1A/5A ; 0.05-12Ion	-	4	4	Y	Y	-	-	13.419.000	2
	REL15009	90-240 VAC/VDC	1A/5A ; 0.05-12Ion	-	4	4	Y	Y	-	-	13.419.000	2
Model A	REL15010	24-60 VAC/VDC	1A/5A ; 0.01-2 Ion	-	4	8	Y	Y	Y	-	14.380.000	2
	REL15011	90-240 VAC/VDC	1A/5A ; 0.01-2 Ion	-	4	8	Y	Y	Y	-	14.380.000	2
	REL15012	24-60 VAC/VDC	1A/5A ; 0.05-12Ion	-	4	8	Y	Y	Y	-	14.380.000	2
	REL15013	90-240 VAC/VDC	1A/5A ; 0.05-12Ion	-	4	8	Y	Y	Y	-	14.380.000	2
Model E	REL15014	24-60 VAC/VDC	1A/5A ; 0.01-2 Ion	-	8	6	Y	Y	Y	Y	14.380.000	2
	REL15015	90-240 VAC/VDC	1A/5A ; 0.01-2 Ion	-	8	6	Y	Y	Y	Y	14.380.000	2
	REL15016	24-60 VAC/VDC	1A/5A ; 0.05-12Ion	-	8	6	Y	Y	Y	Y	14.380.000	2
	REL15017	90-240 VAC/VDC	1A/5A ; 0.05-12Ion	-	8	6	Y	Y	Y	Y	14.380.000	2
Model E+ with Directional Earth Fault	REL15020	24-60 VAC/VDC	1A/5A ; 0.01-2 Ion	Y	8	6	Y	Y	Y	Y	15.062.000	2
	REL15021	90-240 VAC/VDC	1A/5A ; 0.01-2 Ion	Y	8	6	Y	Y	Y	Y	15.062.000	2
	REL15022	24-60 VAC/VDC	1A/5A ; 0.05-12Ion	Y	8	6	Y	Y	Y	Y	15.062.000	2
	REL15023	90-240 VAC/VDC	1A/5A ; 0.05-12Ion	Y	8	6	Y	Y	Y	Y	15.062.000	2

■ P1V - Voltage Protection Relay

Model	Referensi	Power Supply Vx	Vn Range	V4	DI	DO	RS485	Front USB	Dist. Rec	Frequency Protection	Harga (Rp) (Sebelum PPN)	SS
Model N	REL15024	24-240 VAC/VDC	57-130 VAC	-	-	4	-	-	-	-	15.062.000	2
	REL15025	24-240 VAC/VDC	220-480 VAC	-	-	4	-	-	-	-	15.062.000	2
Model B	REL15026	24-60 VAC/VDC	57-130 VAC	Y	2	6	Y	Y	-	-	17.803.000	2
	REL15027	24-60 VAC/VDC	220-480 VAC	Y	2	6	Y	Y	-	-	17.803.000	2
	REL15028	90-240 VAC/VDC	57-130 VAC	Y	2	6	Y	Y	-	-	17.803.000	2
	REL15029	90-240 VAC/VDC	220-480 VAC	Y	2	6	Y	Y	-	-	17.803.000	2
Model A	REL15030	24-60 VAC/VDC	57-130 VAC	Y	6	8	Y	Y	Y	Y	19.168.000	2
	REL15031	24-60 VAC/VDC	220-480 VAC	Y	6	8	Y	Y	Y	Y	19.168.000	2
	REL15032	90-240 VAC/VDC	57-130 VAC	Y	6	8	Y	Y	Y	Y	19.168.000	2
	REL15033	90-240 VAC/VDC	220-480 VAC	Y	6	8	Y	Y	Y	Y	19.168.000	2

Relay Proteksi PowerLogic P3

Deskripsi Produk



■ Relay Proteksi PowerLogic P3

Relay yang kompak untuk aplikasi standar di Tegangan Menengah dan mudah digunakan, sehingga cocok untuk Panel builder dan kontraktor di proyek yang tidak terlalu kompleks. Mulai dari proteksi overcurrent yang simpel, hingga advanced protection dengan opsional proteksi Arc flash, serta dilengkapi dengan pilihan komunikasi scada yang lengkap.

PowerLogic P3 Connected MV Protection Relays

PowerLogic P3 didesain untuk meningkatkan efisiensi, konektifitas, dan keselamatan. Satu buah peralatan relay proteksi universal yang dapat digunakan untuk berbagai aplikasi seperti: proteksi feeder, transformer, motor, busbar, capacitor, tegangan dan frekuensi.

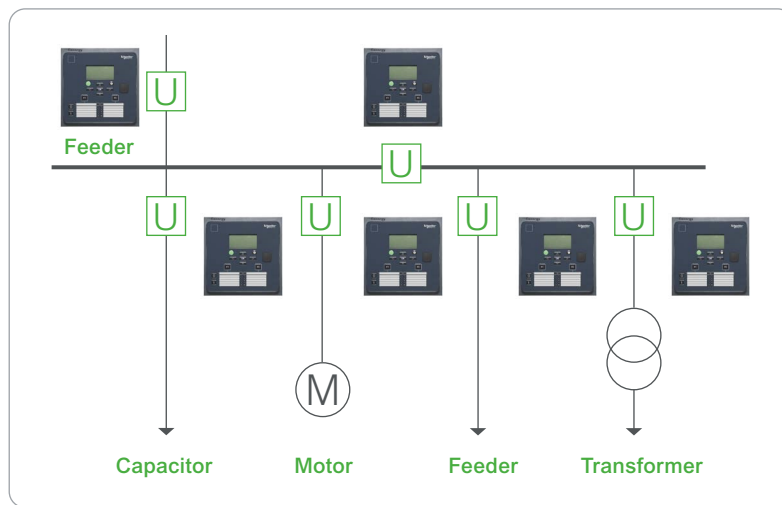

■ Spesifikasi

Dimensi relay (Lebar x Depth x Tinggi) : 171 mm x 214 mm x 176 mm

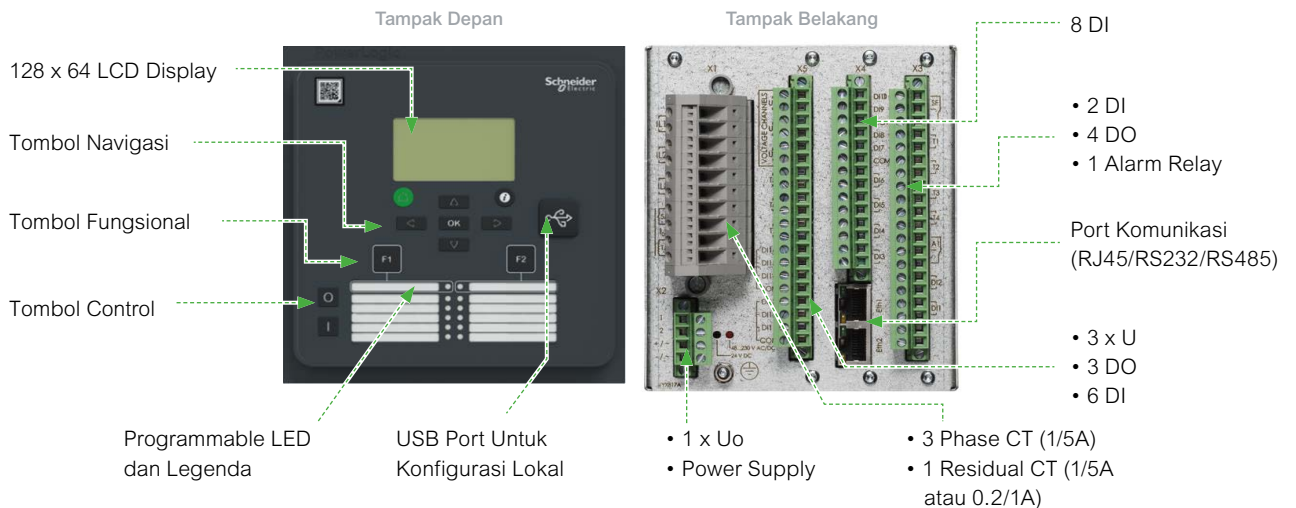

Model dan Fitur

Model*	CT & VT Input	Digital Input/ Output	Overcurrent Protection (ANSI 50/51)	Voltage Protection (ANSI 27/59)	Directional Overcurrent (ANSI 67)	Synchro Check (ANSI 25)	Scada Communication	Programmable Logic
P3U20	4 CT & 1 VT	10 DI / 5 DO	●	○	○	○	●	●
P3U30	4 CT & 4 VT	16 DI / 8 DO	●	●	●	●	●	●

*) Semua model relay sudah memiliki port komunikasi yang harus dipilih jenisnya saat pembelian.

■ Fitur fungsi proteksi secara lengkap dapat dilihat di Katalog PowerLogic P3 Universal.

● Tersedia ○ Tidak Tersedia



- Display LCD dengan tampilan grafis memberikan kemudahan pembacaan dan penggunaan.
- Software konfigurasi **Easergy Pro** yang memiliki fitur lengkap, informatif, dan mudah digunakan.
- Fitur **Virtual Injection** yang memudahkan saat proses instalasi dan komisioning.
- Konektor yang dapat dilepas memberikan kemudahan dan keamanan saat instalasi dan komisioning tanpa perlu melepas satu per satu wiring.
- Operasional lebih mudah dengan aplikasi SmartApp di Smartphone (Android dan Apple iOS) dan fitur web server.
- Mendukung 9 protokol komunikasi yang sesuai standar teknologi terbaru, yaitu: Ethernet IP, Modbus RTU/TCP, DNP3.0 Serial/TCP, IEC101, IEC103, DeviceNet, ProfibusDP, SPA Bus, dan IEC-61850.



Scan untuk Katalog Lengkap PowerLogic P3

Software "eSetup Easergy Pro"

eSetup Easergy Pro offers full facilities to set up PowerLogic P3 Protection relays. Intuitive and simple.

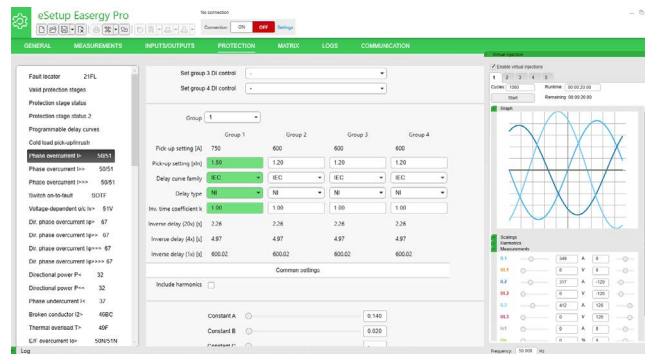

Scan untuk unduh Software konfigurasi **Easergy Pro** secara gratis

Aplikasi "Power Device SmartApp"

Download Power Device SmartApp for simpler and safer operation and maintenance.

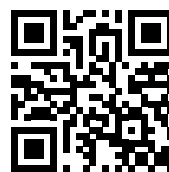

Scan untuk unduh Aplikasi **Power Device SmartApp**



Relay Proteksi PowerLogic P3

PowerLogic P3 Universal dan Aksesori



Scan untuk memilih Produk & Data Sheet

■ PowerLogic P3 Universal

Tipe	Power Supply	Threshold Teg. Digital Input	Port Komunikasi	Input Arus Earth Fault	Referensi /Product Code	Harga (Rp) (Sebelum PPN)	SS
P3U20	48 - 230 VAC/DC	110 - 230 VAC/DC	RS-485	1 A / 5 A	REL52037	35.669.000	2
	48 - 230 VAC/DC	110 - 230 VAC/DC	RS-485	CSH	P3U20-5CAA2ABAA	35.669.000	2
	48 - 230 VAC/DC	110 - 230 VAC/DC	2x RJ-45	1 A / 5 A	REL52018	37.034.000	2
	48 - 230 VAC/DC	110 - 230 VAC/DC	2x RJ-45	CSH	P3U20-5CAA2ACAA	37.034.000	2
	48 - 230 VAC/DC	110 - 230 VAC/DC	RJ-45 + RS-232	1 A / 5 A	P3U20-5AAA2AEAA	37.539.000	2
	48 - 230 VAC/DC	110 - 230 VAC/DC	RJ-45 + RS-232	CSH	P3U20-5CAA2AEAA	37.539.000	2
P3U30	48 - 230 VAC/DC	110 - 230 VAC/DC	RS-485	1 A / 5 A	REL52012	43.061.000	2
	48 - 230 VAC/DC	110 - 230 VAC/DC	RS-485	CSH	P3U30-5CAA2BBAA	43.061.000	2
	48 - 230 VAC/DC	110 - 230 VAC/DC	2x RJ-45	1 A / 5 A	REL52004	44.426.000	2
	48 - 230 VAC/DC	110 - 230 VAC/DC	2x RJ-45	CSH	P3U30-5CAA2BCAA	44.426.000	2
	48 - 230 VAC/DC	110 - 230 VAC/DC	RJ-45 + RS-232	1 A / 5 A	P3U30-5AAA2BEAA	46.270.000	2
	48 - 230 VAC/DC	110 - 230 VAC/DC	RJ-45 + RS-232	CSH	P3U30-5CAA2BEAA	46.270.000	2

Catatan :

- Jika arus Earth Fault didapat dari core balance CT tipe CSH120/CSH200, maka harus dipilih tipe relay dengan Input Arus Earth Fault = CSH
- Produk dengan konfigurasi standar menggunakan referensi **REL520●●●**. Sedangkan untuk produk dengan konfigurasi non-standar menggunakan **Product Code P3U●0-●●●●●●●●** yang juga bisa didapat dari **product selector/pemilih produk** di website Schneider.
- Untuk produk PowerLogic P3 Universal yang berbeda dari konfigurasi produk di atas, silahkan scan QR Code di samping kemudian melakukan konfigurasi pemilihan selektor produk. Atau langsung menghubungi PT. Schneider Indonesia.

■ Modul Tambahan dan Aksesori

Deksripsi	Referensi	Harga (Rp) (Sebelum PPN)	SS
USB programming cable (PowerLogic Pro)	REL52822	320.000	2
Raising frame, 45 mm	REL52834	2.972.000	2
P3U Panel Seal Cover	REL52833	2.378.000	2
RS232 - VSE (1xD9) cable	REL52825	1.176.000	2
RS232 - Remote/Ext. (3xD9) cable	REL52826	2.305.000	2
RS232 - VPA 3CG (Profibus) cable	REL52827	3.239.000	2
VPA3CGSE - Profibus interface modul	REL52815	14.207.000	2
VSE002 - RS485 module	REL52820	6.479.000	2
VIO12AASE 24-230 V RTD module 12 RTD inputs Optical Tx	REL52811	24.528.000	2
VIO12ABSE 24-230 V RTD module 12 RTD inputs RS485	REL52812	24.707.000	2
VIO12ADSE 48-230 V RTD module 12 RTD inputs 4/4 mA IN/OUT	REL52814	37.506.000	2
CSH120 (Residual current sensor)	59635	5.308.000	2
CSH200 (Residual current sensor)	59636	10.127.000	2

Relay Proteksi PowerLogic P3 Advance

Deskripsi Produk



PowerLogic P3 Advanced

Advanced Protection Relays for Demanding Applications

Relay Proteksi PowerLogic P3 Advance

PowerLogic P3 Advance menggunakan platform yang sama dengan PowerLogic P3 Universal, namun dikembangkan untuk memenuhi kebutuhan fungsi proteksi lebih lanjut pada Feeder, line differential, Motor, Generator, dan Transformer.

Semua fitur yang ada di PowerLogic P3 Universal ada juga di PowerLogic P3 Advance, namun dengan dimensi yang lebih besar, fungsi proteksi yang lebih lengkap dan juga dilengkapi dengan kapabilitas embedded Arc Flash Protection.

Model	Function
PowerLogic P3F30	Advance Feeder Protection
PowerLogic P3L30	Line Differential and Distance Protection
PowerLogic P3M30	Motor Protection
PowerLogic P3M32	Motor with Differential Protection
PowerLogic P3T32	Transformer Differential Protection
PowerLogic P3G30	Generator Protection
PowerLogic P3G32	Generator with Differential Protection

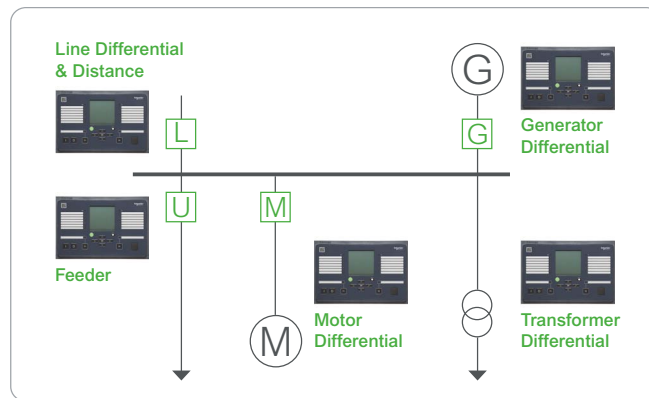

Perbandingan PowerLogic P3 Universal dengan PowerLogic P3 Advance

Application	PowerLogic P3 Universal		PowerLogic P3 Advance	
	Skematik			
Feeder		P3U20 Non-Directional OC		P3F30 - P3L30 -
Transformer		P3U30 Directional OC and Voltage Protection		P3T32 with Differential
Motor				P3M30 - P3M32 with Differential
Generator				P3G30 - P3G32 with Differential
Measuring Inputs		1/5 A CT (x3)	1/5 A CT (x3)	1/5 A CT (x6)
Residual Current (I _o)		1/5 A or 0.2/1A or CSH CT		1/5 A or 0.2/1A or CSH CT
Voltage (V)		VT (x1)	VT (x4)	VT (x4)
Arc Flash Sensor Input		-		0 to 4 point sensor
Digital		8 or 10	14 or 16	6 to 36
Input		8 or 10	14 or 16	6 to 16
Output		(5 or 8) + SF	(11 or 8) + SF	10 to 21 + SF
Temperature RTD Input		8 Input with External RTD module		8 Input with External RTD module
Nominal Power Supply		24 VDC or 48-230 VAC/DC		24-48 VDC or 110-230 VAC/DC
Operating Ambient Temperature		-40...60°C		-40...60°C
Virtual Injection		Available		Available

■ Panduan Pemilihan Produk

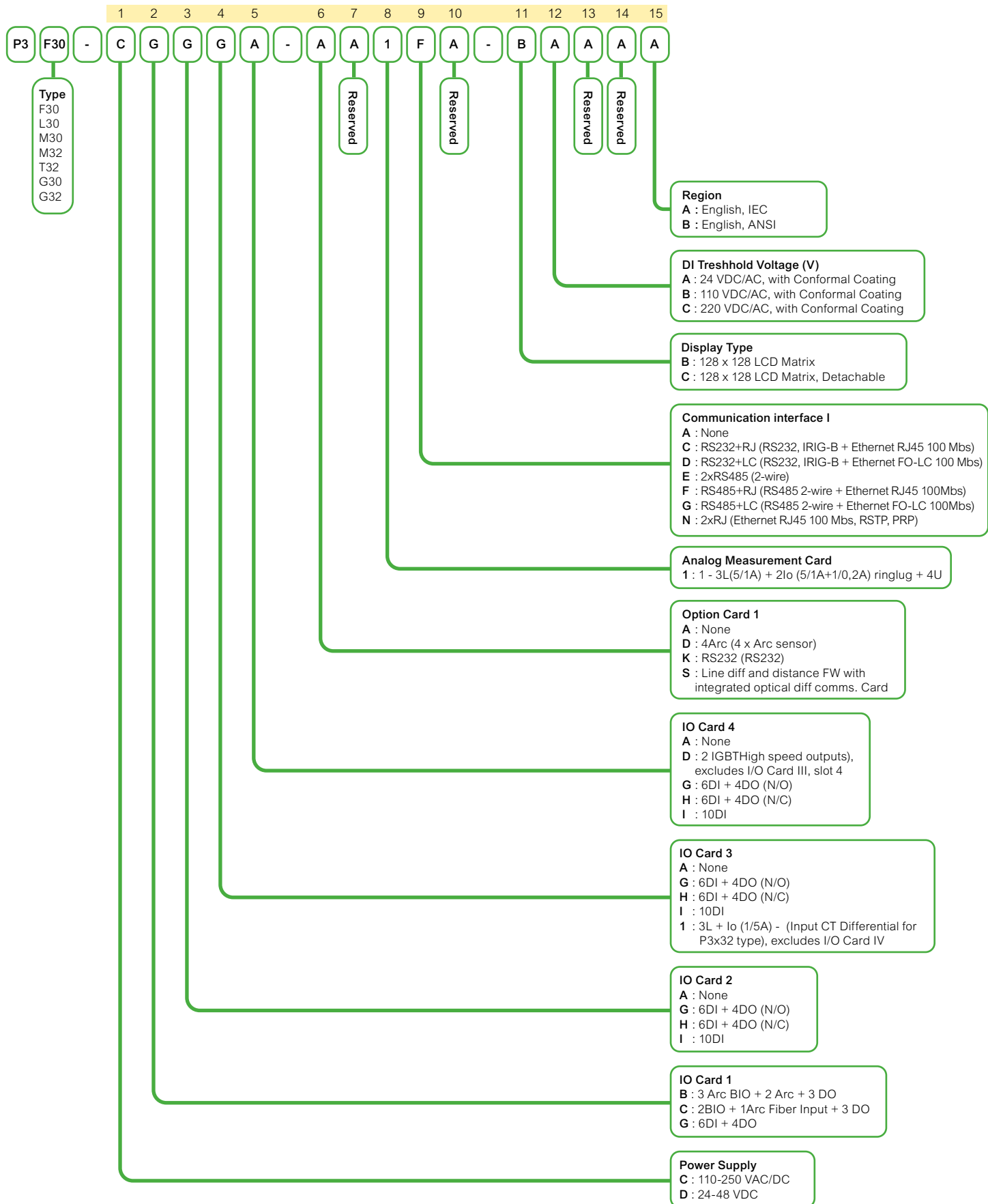



Scan untuk
Pemilih Produk &
Data Sheet

■ PowerLogic P3 Advance

Tipe	Power Supply	Port Komunikasi	Jumlah Digital Input/ Output	Arc Flash Input	Product Code	Harga (Rp) (Sebelum PPN)	SS
PowerLogic P3F30	110-230 VAC/DC	Eth. RJ45 +RS-485	18 DI - 17 DO	-	P3F30-CGGGA-AA1FA-BAAAA	74.000.000	2
			9 DI - 14 DO	6 Sensor	P3F30-CBGAD-DA1FA-BAAAA	85.500.000	2
PowerLogic P3L30 ⁽¹⁾	110-230 VAC/DC	Eth. RJ45 +RS-485	18 DI - 17 DO	-	P3L30-CGGGA-SA1FA-BAAAA	106.500.000	2
			9 DI - 14 DO	2 Sensor	P3L30-CBGAD-SA1FA-BAAAA	115.000.000	2
PowerLogic P3M30	110-230 VAC/DC	Eth. RJ45 +RS-485	18 DI - 17 DO	-	P3M30-CGGGA-AA1FA-BAAAA	95.000.000	2
			9 DI - 14 DO	6 Sensor	P3M30-CBGAD-DA1FA-BAAAA	106.500.000	2
PowerLogic P3M32	110-230 VAC/DC	Eth. RJ45 +RS-485	12 DI - 13 DO	-	P3M32-CGG1A-AA1FA-BAAAA	101.800.000	2
			9 DI - 12 DO	6 Sensor	P3M32-CBG1A-DA1FA-BAAAA	107.050.000	2
PowerLogic P3T32	110-230 VAC/DC	Eth. RJ45 +RS-485	12 DI - 13 DO	-	P3T32-CGG1A-AA1FA-BAAAA	96.500.000	2
			9 DI - 12 DO	6 Sensor	P3T32-CBG1A-DA1FA-BAAAA	101.750.000	2
PowerLogic P3G30	110-230 VAC/DC	Eth. RJ45 +RS-485	18 DI - 17 DO	-	P3G30-CGGGA-AA1FA-BAAAA	96.000.000	2
			9 DI - 14 DO	6 Sensor	P3G30-CBGAD-DA1FA-BAAAA	107.500.000	2
PowerLogic P3G32	110-230 VAC/DC	Eth. RJ45 +RS-485	12 DI - 13 DO	-	P3G32-CGG1A-AA1FA-BAAAA	101.800.000	2
			9 DI - 12 DO	6 Sensor	P3G32-CBG1A-DA1FA-BAAAA	107.050.000	2

Catatan :

- (1) Khusus tipe P3L30 memiliki 1 port komunikasi tambahan menggunakan Fiber Optic untuk komunikasi Line Differential (87L) dengan relay di lawannya.
- Untuk konfigurasi relay yang berbeda dari produk standar di atas, Anda dapat melakukan konfigurasi pada panduan pemilih produk di halaman sebelumnya atau silakan Scan QR Code di samping kemudian melakukan konfigurasi pemilihan selektor produk.

■ Modul Tambahan dan Aksesori

Deskripsi	Referensi	Harga (Rp) (Sebelum PPN)	SS
USB programming cable (PowerLogic Pro)	REL52822	320.000	2
VPA3CGSE - Profibus interface module	REL52815	14.207.000	2
VIO12AASE 24-230 V RTD module 12 RTD inputs Optical Tx	REL52811	24.528.000	2
VIO12ABSE 24-230 V RTD module 12 RTD inputs RS485	REL52812	24.707.000	2
VIO12ADSE 48-230 V RTD module 12 RTD inputs 4/4 mA IN/OUT	REL52814	37.506.000	2
CSH120 (Residual current sensor)	59635	5.308.000	2
CSH200 (Residual current sensor)	59636	10.127.000	2
Arc Point Sensor 6m cable length	REL52804	1.350.000	2
Arc Point Sensor 20m cable length	REL52801	2.000.000	2
Surface Mounting Plate for Sensors Z-shaped	VYX001	560.500	2
Surface Mounting Plate for Sensors L-shaped	VYX002	487.000	2

PowerLogic™ Arc Relay Proteksi Arc Flash



PowerLogic Arc adalah produk baru dari Schneider Electric yang memiliki fungsi untuk melakukan mitigasi gangguan Arc di dalam **MV** maupun **LV** Switchgear panel.

Penggunaan relay proteksi arc flash secara signifikan dapat mengurangi dampak kerusakan pada switchgear panel yang terjadi karena adanya gangguan arc. Gangguan arc flash dapat terjadi karena beberapa faktor, seperti kesalahan saat proses instalasi, koneksi yang kurang kencang atau lepas, dan gangguan pada sistem.

i **PowerLogic Arc** terdiri dari dua tipe, yaitu **A1** dan **A3**. Sensor yang digunakan masih sama dengan tipe Vamp yaitu sensor cahaya VA1DA-x.



Scan QR Code untuk katalog lengkap PowerLogic Arc

Model dan Fitur

Model	Unit Device	Deskripsi fungsi
PowerLogic A1	A125	Stand-alone relay arc flash dilengkapi dengan 4 input sensor arc
PowerLogic A3	A3-F6P	Unit utama relay arc flash dilengkapi dengan 6 input sensor arc, multi-zone control
PowerLogic A3	A3-F12P	Unit utama relay arc flash dilengkapi dengan 12 input sensor arc untuk menambah cakupan sensor
PowerLogic A3	A3-S6P	Extension unit dilengkapi dengan 6 input sensor dan kontrol
PowerLogic A3	A3-S12P	Extension unit dilengkapi dengan 12 input sensor

Cara kerja relay proteksi arc flash PowerLogic Arc

- Mendeteksi cahaya arc flash dengan menggunakan sensor cahaya khusus. Atau dikombinasikan dengan deteksi pick-up arus berlebih dari relay proteksi lain.
- Ketika terdeteksi arc flash, sensor cahaya mengirimkan sinyal ke relay Arc dan kemudian unit relay Arc akan mengerjakan kontak relay untuk melakukan trip CB.
- Khusus untuk tipe PowerLogic A3, dapat dikoordinasikan dengan breaker dari breaker lain sehingga menjadi satu sistem Arc flash protection.
- Waktu respon dan relay kontak High-Speed Output dari relay PowerLogic Arc adalah 1-2 mili second.

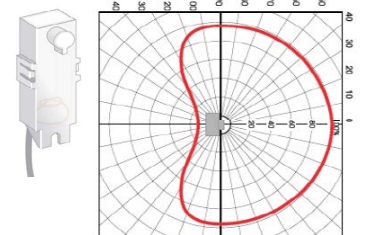

Sensor Arc Flash dan sensitifitasnya berdasarkan sudut

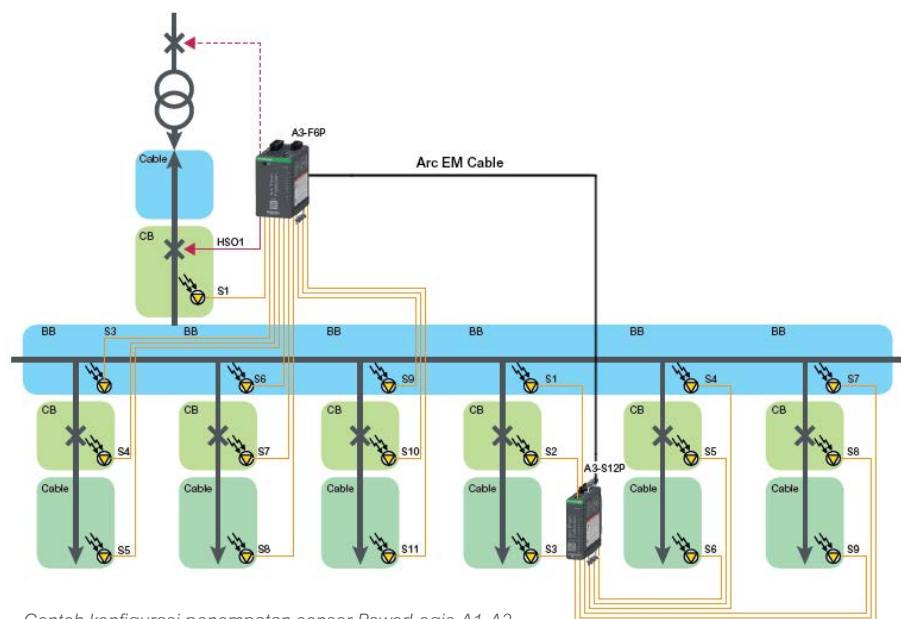

Contoh konfigurasi penempatan sensor PowerLogic A1-A3

PowerLogic™ A1 & A3

Relay Proteksi Arc Flash



A125



A3-F6P

A3-F12P



A3-S6P

A3-S12P

A3 Configuration
Arc EM cable to RJ45VA1DA-x
Sensor Cahaya ArcA3 Arc EM cable
Comm and PoE

VYX001



VYX002

PowerLogic Arc Unit

Tipe	Power Supply	Jmlh. Input Sensor	Trip Output	Referensi	Harga (Rp) (Sebelum PPN)	SS
A125 Arc flash stand-alone unit	External 48-240 VAC/VDC	4	2	REL52900	15.000.000	2
A3 F6P Arc flash main unit	External 48-240 VAC/VDC	6	3	REL52920	17.500.000	2
A3 F12P Arc flash main unit	External 48-240 VAC/VDC	12	2	REL52921	18.200.000	2
A3 S6P Arc flash extension unit	PoE (Power over Ethernet)	6	1	REL52930	10.500.000	2
A3 S12P Arc flash extension unit	PoE (Power over Ethernet)	12	0	REL52931	11.200.000	2

Catatan :

- Konfigurasi relay A125 menggunakan dip switch
- Konfigurasi relay A3 dapat menggunakan 2 cara, yaitu menggunakan rotary switch, atau melalui software Easergy Pro yang terhubung ke PC/laptop dengan kabel A3 configuration Arc EM Cable to RJ45.
- Komunikasi antara A3 main unit dan A3 extension unit menggunakan kabel A3 Arc EM. Extension unit tidak memerlukan power supply eksternal

Sensor dan Aksesoris

	Deskripsi	Referensi	Harga (Rp) (Sebelum PPN)	SS
Arc Flash Sensor	Arc Point Sensor 6m cable length	REL52804	1.350.000	2
	Arc Point Sensor 20m cable length	REL52801	2.000.000	2
Sensor dan Unit Mounting	Surface Mounting Plate for Sensors Z-shaped	VYX001	560.500	2
	Surface Mounting Plate for Sensors L-shaped	VYX002	487.000	2
	A3S Front Mounting Frame Small size	REL52902	1.500.000	2
	A3S and A125 Front Mounting Frame Large size	REL52903	1.500.000	2
Kabel konfigurasi dan komunikasi	A3 Configuration Arc EM cable to RJ45	REL52960	1.800.000	2
	A3 Arc EM cable 1 meter Comm and PoE	REL52961	1.200.000	2
	A3 Arc EM cable 2 meter Comm and PoE	REL52962	1.280.000	2
	A3 Arc EM cable 3 meter Comm and PoE	REL52963	1.365.000	2
	A3 Arc EM cable 5 meter Comm and PoE	REL52964	1.450.000	2
	A3 Arc EM cable 10 meter Comm and PoE	REL52965	1.630.000	2



Life Is On

Schneider
Electric

Miniature Circuit Breaker (MCB)	5-3
Miniature Circuit Breaker (MCB) - Domae	5-3
RCCB / ELCB, MCB Box, dan Busbar Sisir - Domae	5-4
RCBO Slim dan Surge Arrester - Domae	5-5
Miniature Circuit Breaker (MCB) - Acti9 iK60A 4.5 kA	5-6
Miniature Circuit Breaker (MCB) - Acti9 iK60N 6 kA	5-7
Miniature Circuit Breaker (MCB) - Acti9 iC60N 6 kA	5-8
Miniature Circuit Breaker (MCB) - Acti9 iC60H-C 10 kA	5-9
Miniature Circuit Breaker (MCB) - Acti9 iC60H-D 10 kA	5-10
Miniature Circuit Breaker (MCB) - Acti9 iC60L 15 - 100kA	5-11
Miniature Circuit Breaker (MCB) - Acti9 C120N/H 10/15 kA	5-12
Miniature Circuit Breaker (MCB) - Acti9 C60H-DC	5-14
Pengaman Arus Bocor	5-15
Acti9 RCCB / ELCB iID	5-15
RCBO iDPN N Vigi	5-16
Dikombinasikan dengan iC60 dan C120 - Modul Vigi	5-17
Kontaktor Acti9 (iCT)	5-18
MCB Box Mini Pragma	5-19
Mini Pragma Pintu Transparan	5-19
Mini Pragma Pintu Biasa	5-19
Isobar	5-20
Aksesori	5-21
Aksesori MCB, RCCB/ELCB iID, iDPN Vigi, iSW, RCA, ARA & Reflex	5-21
Connection Devices	5-22
Busbar Sisir Horizontal 18 mm pitch	5-22
Surge Arrester	5-23
Surge Arrester Tipe 1 dan Tipe 1 + 2	5-23
Surge Arrester Tipe 2 (Fixed Type)	5-24
Surge Arrester Tipe 2 (Draw out)	5-24
Cartridge untuk tipe iPRD	5-24
Surge Arrester PRI	5-25
Command Control	5-25
Pengaman Peralatan Motor	5-25
PC Socket, Fuse Carrier, dan Pilot Lights	5-26
Acti 9 iTL Relay Impuls	5-27
Control Switches & Disconnection	5-28
Time Delay (iRT)	5-29



Miniature Circuit Breaker (MCB) Domae

■ Domae Miniature Circuit Breaker (MCB)

Untuk pemakaian dengan arus hubung singkat $\leq 6kA$

- Kapasitas pemutusan:
 - Standar SNI 8528-1:2018 mengacu IEC 60898-1:2015
 - $I_{cn} = 6000A$ (230V - 1P, 400V 2-3P).
- Kurva C (magnetis trip antara 5 dan 10 In).
- Daya Tahan MCB :
 - Electrical Trip: 10,000 kali
 - Mechanical Trip: 20,000 kali



MCB Domae
1 Kutub

1 Kutub



MCB Domae
2 Kutub

2 Kutub

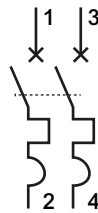

MCB Domae
3 Kutub

3 Kutub

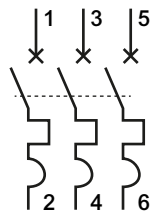

Jumlah kutub	Pengenal (A)	Referensi	Harga (Rp) (Sebelum PPN)	SS
1 Kutub	2	DOMF01102	113.500	1
	4	DOMF01104	113.500	1
	6	DOMF01106	91.000	1
	10	DOMF01110	91.000	1
	16	DOMF01116	91.000	1
	20	DOMF01120	91.000	1
	25	DOMF01125	101.000	1
	32	DOMF01132	104.000	1
	40	DOMF01140	127.000	1
	50	DOMF01150	262.000	1
2 Kutub	63	DOMF01163	262.000	1
	2	DOMF01202	333.000	1
	4	DOMF01204	333.000	1
	6	DOMF01206	256.000	1
	10	DOMF01210	256.000	1
	16	DOMF01216	256.000	1
	20	DOMF01220	256.000	1
	25	DOMF01225	291.500	1
	32	DOMF01232	304.000	1
	40	DOMF01240	358.500	1
3 Kutub	63	DOMF01263	589.000	1
	6	DOMF01306	416.500	1
	10	DOMF01310	416.500	1
	16	DOMF01316	416.500	1
	20	DOMF01320	416.500	1
	25	DOMF01325	449.000	1
	32	DOMF01332	484.500	1
	40	DOMF01340	567.500	1
	50	DOMF01350	937.000	1
	63	DOMF01363	937.000	1



ECLB Domae
1P + N



ECLB Domae
3P + N



MCB Box Domae
Pintu Transparan

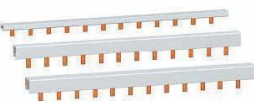

Busbar Sisir



Busbar Sisir
Meteran

RCCB / ELCB, MCB Box dan Busbar Sisir Domae

■ RCCB (Residual Current Circuit Breaker) Domae

- Proteksi arus bocor.
- 30 mA untuk proteksi terhadap manusia.
- 300 mA untuk proteksi terhadap bahaya kebakaran.
- Cocok untuk aplikasi distribusi akhir untuk rumah dan apartemen.
- Standar SNI 04-6956.2.1-2005

Jumlah kutub	Sensitivitas	Pengenal (A)	Referensi	Harga (Rp) (Sebelum PPN)	SS
1P + N	30 mA	25	DOMR01225	691.000	1
		40	DOMR01240	759.000	1
		63	DOMR01263	986.500	1
	300 mA	25	DOMR02225	725.000	1
		40	DOMR02240	797.000	1
		63	DOMR02263	1.036.000	1
3P + N	30 mA	25	DOMR01425	1.036.000	1
		40	DOMR01440	1.138.500	1
		63	DOMR01463	1.539.000	1
	300 mA	25	DOMR02425	1.087.500	1
		40	DOMR02440	1.243.000	1
		63	DOMR02463	1.553.500	1

■ MCB Box Domae Pintu Transparan

- Sesuai dengan standar internasional IEC 61439-3.
- Proteksi kelas 2 (melindungi pengguna dari kontak langsung).
- Index Proteksi (IP) 40.
- Tipe Inbow / Flush (tertanam).

Jumlah Baris	Dimensi (mm)			Modul	Referensi	Harga (Rp) (Sebelum PPN)	SS
	T	L	Tb				
1	222	136	92	4	DOMH12104F	117.000	1
1	222	208	92	8	DOMH12108F	166.500	1
1	222	280	92	12	DOMH12112F	211.000	1

■ Busbar Sisir

Tipe	Pengenal (A)	Lebar in Module (9 mm)	Deskripsi	Referensi	Harga (Rp) (Sebelum PPN)	SS
1 Ph	63	24	1 x 12-modul Busbar Sisir 1 x 10 mm ²	EZ9XPH112	67.000	1
2 Ph	63	24	1 x 12-modul Busbar Sisir 2 x 10 mm ²	EZ9XPH212	107.500	2
3 Ph	63	24	1 x 12-modul Busbar Sisir 3 x 10 mm ²	EZ9XPH312	131.500	1

Tipe	Pengenal (A)	Panjang (m)	Deskripsi	Referensi	Harga (Rp) (Sebelum PPN)	SS
1 Ph	63	1	1 recutable 1 mbar 1 x 10 mm ²	EZ9XPH157	270.000	2
2 Ph	63	1	1 recutable 2 mbar 1 x 10 mm ²	EZ9XPH257	485.000	2
3 Ph	63	1	1 recutable 3 mbar 1 x 10 mm ²	EZ9XPH357	699.000	1



RCBO Slim dan Surge Arrester Domae

RCBO Slim Domae

Untuk pemakaian dengan arus hubung singkat $\leq 6kA$

- Perlindungan terhadap bahaya sengatan listrik (ELCB 30mA) sekaligus beban berlebih (MCB dengan breaking capacity 6000A)
- Ukuran yang slim, lebar 18mm sama seperti lebar MCB 1P, sangat cocok untuk penggantian MCB dan tambahan proteksi ELCB dengan tempat terbatas tanpa perlu mengganti box
- Hanya akan memutuskan bagian yang terdapat gangguan arus bocor

Spesifikasi	MCB	ELCB	RCBO
Perlindungan Beban Lebih	Ya	Tidak	Ya
Perlindungan Hubung Singkat	Ya	Tidak	Ya
Perlindungan Arus Bocor	Tidak	Ya	Ya
Lebar 1 Kutub	18 mm	36 mm	18 mm
Sensitivitas Arus Bocor	-	30mA, 300mA	30mA



RCBO Domae
1P + N

Jumlah kutub	Sensitivitas	Pengenal (A)	Referensi	Harga (Rp) (Sebelum PPN)	SS
1P + N	30 mA	6	DOMD01606	766.500	1
		10	DOMD01610	766.500	1
		16	DOMD01616	766.500	1
		20	DOMD01620	766.500	1
		25	DOMD01625	843.000	1

Surge Arrester Domae PF

- Surge Arrester Tipe 2 yang direkomendasikan untuk melindungi peralatan elektronik residential (rumah tinggal) terhadap bahaya petir tidak langsung.
- Harus di instal dengan proteksi MCB (MCB Domae 20A)
- Maximum Discharge Current (I max) 40kA



Surge Arrester
Domae PF
1P

Tipe	Lebar	Referensi	Harga (Rp) (Sebelum PPN)	SS
Domae PF 1P	18 mm	DOML01140	343.500	2
Domae PF 1P+N	36 mm	DOML01640	807.500	2
Domae PF 3P	72 mm	DOML01340	1.133.500	2
Domae PF 3P+N	72 mm	DOML01740	1.459.500	1



IEC 60898-1:2015

Miniature Circuit Breaker (MCB)

Acti 9 iK60A

■ MCB iK60A - Kurva C

Direkomendasikan untuk spesifikasi kapasitas pemutusan 4.5 kA

- Kurva C (magnetis trip antara 5 dan 10 In) dengan lebar modul per kutub 18mm.
- Ketahanan elektrik (Electrical Trip) 10.000 kali, dan ketahanan mekanikal (Mechanical Trip) 20.000 kali
- Cocok untuk aplikasi gedung komersial dan industri.
- Koneksi kabel ke terminal :
 - 1 sampai 25 A ► maksimum 16 mm² kabel serabut atau 25 mm² kabel tunggal.
 - 32 maksimum 25 mm² kabel serabut atau 35 mm² kabel tunggal.



MCB iK60a
1 Kutub

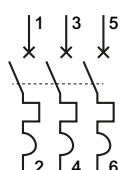

MCB iK60a
3 Kutub

Jumlah kutub	Pengenal (A)	Referensi	Harga (Rp) <i>(Sebelum PPN)</i>	SS
1 Kutub 	6	A9K14106	111.500	1
	10	A9K14110	111.500	1
	16	A9K14116	111.500	1
	20	A9K14120	111.500	1
	25	A9K14125	122.500	1
	32	A9K14132	128.500	1
3 Kutub 	6	A9K14306	505.500	1
	10	A9K14310	505.500	1
	16	A9K14316	505.500	1
	20	A9K14320	505.500	1
	25	A9K14325	540.000	1
	32	A9K14332	589.000	1

Catatan : Tidak memiliki Aksesori



IEC 60898-1:2015

Miniature Circuit Breaker (MCB)

Acti 9 iK60N

■ MCB iK60N - Kurva C

Direkomendasikan untuk spesifikasi kapasitas pemutusan 6 kA

- Kurva C (magnetis trip antara 5 dan 10 In) dengan lebar modul per kutub 18mm.
- Ketahanan elektrikal (Electrical Trip) 10.000 kali, dan ketahanan mekanikal (Mechanical Trip) 20.000 kali.
- Cocok untuk aplikasi gedung komersial dan industri.
- Koneksi kabel ke terminal :
 - 1 sampai 25 A ► maksimum 16 mm² kabel serabut atau 25 mm² kabel tunggal.
 - 32 A sampai 40 A ► maksimum 25 mm² kabel serabut atau 35 mm² kabel tunggal.



MCB iK60N
1 Kutub



MCB iK60N
2 Kutub



MCB iK60N
3 Kutub

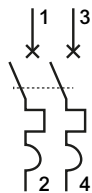
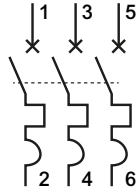
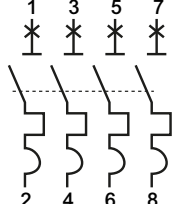

MCB iK60N
4 Kutub

Jumlah kutub	Pengenal (A)	Referensi	Harga (Rp) <i>(Sebelum PPN)</i>	SS
1 Kutub 	2	A9K24102	167.500	1
	4	A9K24104	149.000	1
	6	A9K27106	128.000	1
	10	A9K27110	122.500	1
	16	A9K27116	122.500	1
	20	A9K27120	122.500	1
	25	A9K27125	141.000	1
	32	A9K27132	154.000	1
	40	A9K24140	171.500	1
2 Kutub 	6	A9K27206	313.000	1
	10	A9K27210	307.000	1
	16	A9K27216	307.000	1
	20	A9K27220	307.000	1
	25	A9K27225	353.000	1
	32	A9K27232	368.000	1
	40	A9K24240	444.500	2
	3 Kutub 	6	A9K24306	545.000
10		A9K24310	545.000	1
16		A9K24316	545.000	1
20		A9K24320	545.000	1
25		A9K24325	578.500	1
32		A9K24332	621.000	1
40		A9K24340	681.500	1
4 Kutub 	6	A9K24406	577.000	2
	10	A9K24410	577.000	2
	16	A9K24416	577.000	2
	20	A9K24420	577.000	2
	25	A9K24425	663.000	2
	32	A9K24432	757.000	2
40	A9K24440	865.000	2	

Catatan : Tidak memiliki Aksesoris



IEC 60898-1:2015 : 6kA
IEC 60947-2: 10kA



VisiTrip & VisiSafe



MCB iC60N 1 Kutub



MCB iC60N 2 Kutub



MCB iC60N 3 Kutub



MCB iC60N 4 Kutub

Miniature Circuit Breaker (MCB)

Acti 9 iC60N dengan Indikator Pengaman (VisiTrip & VisiSafe)

■ MCB iC60N - Kurva C

- **Kurva C** (magnetis trip antara 5 dan 10 In) dengan lebar modul per kutub 18mm.
- Ketahanan elektrik (Electrical Trip) 10.000 kali, dan ketahanan mekanikal (Mechanical Trip) 20.000 kali.
- Dapat digunakan untuk jaringan listrik DC
(Untuk 1 Pole hingga 72VDC, 2 Pole hingga 125VDC, 3 Pole hingga 180VDC, 4 Pole hingga 250VDC)
- Koneksi kabel ke terminal :
 - 1 sampai 25 A ► maksimum 16 mm² kabel serabut atau 25 mm² kabel tunggal.
 - 32 sampai 63 A ► maksimum 25 mm² kabel serabut atau 35 mm² kabel tunggal.

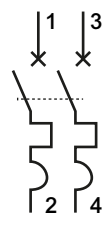
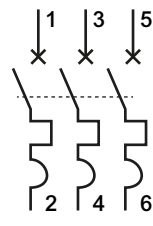
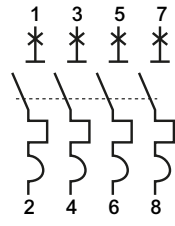
Jumlah kutub	Pengenal (A)	Referensi	Harga (Rp) (Sebelum PPN)	SS
1 Kutub 	1	A9F74101	201.500	1
	2	A9F74102	201.500	1
	4	A9F74104	201.500	1
	6	A9F74106	183.000	1
	10	A9F74110	183.000	1
	16	A9F74116	183.000	1
	20	A9F74120	183.000	1
	25	A9F74125	192.500	1
	32	A9F74132	219.500	1
	40	A9F74140	238.000	1
	50	A9F74150	323.000	1
63	A9F74163	384.500	1	
2 Kutub 	1	A9F74201	549.000	2
	2	A9F74202	549.000	1
	4	A9F74204	549.000	1
	6	A9F74206	458.000	1
	10	A9F74210	457.500	1
	16	A9F74216	457.500	1
	20	A9F74220	457.500	1
	25	A9F74225	572.000	1
	32	A9F74232	618.000	1
	40	A9F74240	663.500	1
	50	A9F74250	747.000	1
63	A9F74263	824.000	1	
3 Kutub 	1	A9F74301	812.500	2
	2	A9F74302	812.500	2
	4	A9F74304	812.500	1
	6	A9F74306	697.500	1
	10	A9F74310	697.500	1
	16	A9F74316	697.500	1
	20	A9F74320	697.500	1
	25	A9F74325	745.000	1
	32	A9F74332	800.000	1
	40	A9F74340	846.500	1
	50	A9F74350	1.185.000	1
63	A9F74363	1.450.500	1	
4 Kutub 	1	A9F74401	1.055.500	2
	2	A9F74402	1.023.500	2
	6	A9F74406	870.000	2
	10	A9F74410	870.000	1
	16	A9F74416	870.000	1
	20	A9F74420	870.000	1
	25	A9F74425	957.000	1
	32	A9F74432	1.131.000	1
	40	A9F74440	1.218.000	1
	50	A9F74450	1.758.500	1
	63	A9F74463	2.063.000	1

Catatan : Aksesori lihat halaman 5-21



IEC 60898-1:2015: 10kA
IEC 60947-2: 15kA



VisiTrip & VisiSafe



MCB iC60H
1 Kutub



MCB iC60H
2 Kutub



MCB iC60H
3 Kutub



MCB iC60H
4 Kutub

Miniature Circuit Breaker (MCB)

Acti 9 iC60H dengan Indikator Pengaman (VisiTrip & VisiSafe)

■ MCB iC60H - Kurva C

- **Kurva C** (magnetis trip antara 5 dan 10 In) dengan lebar modul per kutub 18mm.
- Ketahanan elektrik (Electrical Trip) 10.000 kali, dan ketahanan mekanikal (Mechanical Trip) 20.000 kali.
- Dapat digunakan untuk jaringan listrik DC
(Untuk 1 Pole hingga 72VDC, 2 Pole hingga 125VDC, 3 Pole hingga 180VDC, 4 Pole hingga 250VDC)
- Koneksi kabel ke terminal :
 - 1 sampai 25 A ► maksimum 16 mm² kabel serabut atau 25 mm² kabel tunggal.
 - 32 sampai 63 A ► maksimum 25 mm² kabel serabut atau 35 mm² kabel tunggal.

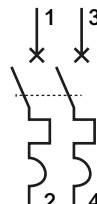
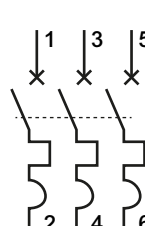
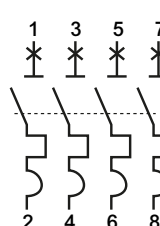
Jumlah kutub	Pengenal (A)	Referensi	Harga (Rp) <i>(Sebelum PPN)</i>	SS
1 Kutub 	1	A9F84101	393.000	2
	2	A9F84102	393.000	2
	4	A9F84104	393.000	1
	6	A9F84106	305.500	1
	10	A9F84110	305.500	1
	16	A9F84116	305.500	1
	20	A9F84120	305.500	1
	25	A9F84125	381.500	1
	32	A9F84132	396.500	1
	40	A9F84140	412.000	1
	50	A9F84150	534.000	2
	63	A9F84163	580.000	1
	2 Kutub 	1	A9F84201	1.024.000
2		A9F84202	1.024.000	1
4		A9F84204	1.024.000	1
6		A9F84206	927.500	1
10		A9F84210	927.500	1
16		A9F84216	927.500	1
20		A9F84220	927.500	2
25		A9F84225	938.500	1
32		A9F84232	981.500	1
40		A9F84240	1.024.000	2
50		A9F84250	1.389.500	1
63		A9F84263	1.476.500	2
3 Kutub 		1	A9F84301	1.315.000
	2	A9F84302	1.315.000	2
	4	A9F84304	1.315.000	2
	6	A9F84306	1.195.500	1
	10	A9F84310	1.195.500	1
	16	A9F84316	1.195.500	1
	20	A9F84320	1.195.500	1
	25	A9F84325	1.232.000	1
	32	A9F84332	1.315.000	1
	40	A9F84340	1.408.000	1
	50	A9F84350	1.674.000	1
	63	A9F84363	1.793.500	1
	4 Kutub 	1	A9F84401	1.665.000
2		A9F84402	1.665.000	2
4		A9F84404	1.665.000	2
6		A9F84406	1.406.000	2
10		A9F84410	1.391.000	1
16		A9F84416	1.391.000	1
20		A9F84420	1.391.000	1
25		A9F84425	1.465.500	2
32		A9F84432	1.927.000	1
40		A9F84440	1.996.000	1
50		A9F84450	2.752.500	1
63		A9F84463	2.959.000	2

Catatan : Aksesori lihat halaman 5-21

Miniature Circuit Breaker (MCB) Acti 9 iC60H dengan Indikator Pengaman (VisiTrip & VisiSafe)



VisiTrip & VisiSafe



MCB iC60H
1 Kutub



MCB iC60H
2 Kutub



MCB iC60H
3 Kutub

IEC 60898-1 : 10kA
IEC 60947-2 : 15kA

■ MCB iC60H - Kurva D

- Kurva D (magnetis trip antara 10 dan 14 In) dengan lebar modul per kutub = 18mm.
- Ketahanan elektrik (Electrical Trip) 10.000 kali, dan ketahanan mekanikal (Mechanical Trip) 20.000 kali.
- Dapat digunakan untuk jaringan listrik DC
(Untuk 1 Pole hingga 72VDC, 2 Pole hingga 125VDC, 3 Pole hingga 180VDC, 4 Pole hingga 250VDC)
- Koneksi kabel ke terminal :
 - 2 sampai 25 A ► maksimum 16 mm² kabel serabut atau 25 mm² kabel tunggal.
 - 32 sampai 63 A ► maksimum 25 mm² kabel serabut atau 35 mm² kabel tunggal.

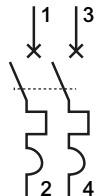
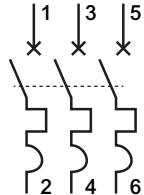
Jumlah kutub	Pengenal (A)	Referensi	Harga (Rp) (Sebelum PPN)	SS
1 Kutub 	2	A9F85102	595.500	2
	4	A9F85104	595.500	2
	6	A9F85106	449.000	2
	10	A9F85110	449.000	2
	16	A9F85116	449.000	2
	25	A9F85125	491.000	2
	32	A9F85132	518.500	2
2 Kutub 	63	A9F85163	743.500	2
	2	A9F85202	1.423.000	2
	4	A9F85204	1.423.000	2
	6	A9F85206	1.115.500	2
	10	A9F85210	1.115.500	2
	16	A9F85216	1.115.500	2
	20	A9F85220	1.115.500	2
3 Kutub 	25	A9F85225	1.227.500	2
	32	A9F85232	1.283.000	2
	6	A9F85306	1.460.500	2
	10	A9F85310	1.460.500	2
	16	A9F85316	1.460.500	2
	20	A9F85320	1.460.500	2
	25	A9F85325	1.606.500	2
3 Kutub	32	A9F85332	1.825.500	2
	40	A9F85340	1.971.500	2
	50	A9F85350	2.209.500	2
	63	A9F85363	2.476.000	2

Catatan : Aksesori [lihat halaman 5-21](#)



VisiTrip & VisiSafe



MCB iC60L
1 Kutub



MCB iC60L
2 Kutub



MCB iC60L
3 Kutub



MCB iC60L
4 Kutub

Miniature Circuit Breaker (MCB)

Acti 9 iC60L dengan Indikator Pengaman (VisiTrip & VisiSafe)

IEC 60947-2 : 100kA ($\leq 4A$), 25kA (6-25A), 20kA (32-40A), 15kA (50-63A)
IEC 60898-1 : 15 kA

■ MCB iC60L

- Kurva C (magnetis trip antara 5 dan 10 In) dengan lebar modul per kutub 18mm.
- Ketahanan elektrik (Electrical Trip) 10.000 kali, dan ketahanan mekanikal (Mechanical Trip) 20.000 kali.
- Dapat digunakan untuk jaringan listrik DC
(Untuk 1 Pole hingga 72VDC, 2 Pole hingga 125VDC, 3 Pole hingga 180VDC, 4 Pole hingga 250VDC)
- Koneksi kabel ke terminal :
 - 1 sampai 25 A ► maksimum 16 mm² kabel serabut atau 25 mm² kabel tunggal.
 - 32 sampai 63 A ► maksimum 25 mm² kabel serabut atau 35 mm² kabel tunggal.

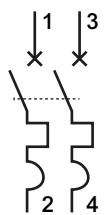
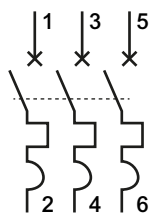
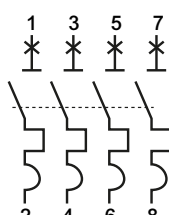
Jumlah kutub	Pengenal (A)	Referensi	Harga (Rp) <i>(Sebelum PPN)</i>	SS
1 Kutub 	2	A9F94102	700.000	2
	4	A9F94104	700.000	2
	6	A9F94106	659.000	2
	10	A9F94110	659.000	2
	16	A9F94116	659.000	2
	20	A9F94120	659.000	2
	25	A9F94125	666.000	2
	32	A9F94132	707.000	2
	40	A9F94140	734.500	2
2 Kutub 	2	A9F94202	1.784.500	2
	4	A9F94204	1.784.500	2
	6	A9F94206	1.716.000	2
	10	A9F94210	1.716.000	2
	16	A9F94216	1.716.000	1
	20	A9F94220	1.716.000	2
	25	A9F94225	1.716.000	2
	32	A9F94232	1.784.500	2
	3 Kutub 	2	A9F94302	2.245.000
6		A9F94306	2.194.500	2
10		A9F94310	2.194.500	2
16		A9F94316	2.194.500	2
20		A9F94320	2.194.500	2
25		A9F94325	2.286.000	2
32		A9F94332	2.324.500	2
40		A9F94340	2.386.500	2
50		A9F94350	2.702.000	2
4 Kutub 	4	A9F94404	3.393.000	2
	6	A9F94406	3.255.500	2
	10	A9F94410	3.255.500	2
	16	A9F94416	3.255.500	2
	20	A9F94420	3.255.500	2
	25	A9F94425	3.363.000	2
	32	A9F94432	3.393.000	2
	40	A9F94440	3.450.500	2
	50	A9F94450	4.237.500	2
63	A9F94463	5.112.000	2	

Catatan : Aksesori lihat halaman 5-21

Miniature Circuit Breaker (MCB)

Acti 9 C120



MCB C120N
1 Kutub



MCB C120N
3 Kutub



MCB C120H
3 Kutub

IEC 60898-1: 10 kA
IEC 60947-2: 10 kA

■ MCB C120N

- **Kurva C** (magnetis trip antara 5 dan 10 In).
- Lebar modul per kutub = 27 mm.
- Dapat digunakan untuk jaringan listrik DC
(Untuk 1 Pole hingga 144VDC, 2 Pole hingga 250VDC, 3 Pole hingga 375VDC, 4 Pole hingga 500VDC)
- Koneksi kabel ke terminal : maksimum 35 mm² kabel serabut atau 50 mm² kabel tunggal.

Jumlah kutub	Pengenal (A)	Referensi	Harga (Rp) (Sebelum PPN)	SS
1 Kutub	80	A9N18357	785.500	2
	100	A9N18358	932.500	1
	125	A9N18359	1.162.500	2
2 Kutub	80	A9N18361	1.644.500	2
	100	A9N18362	1.863.000	2
	125	A9N18363	2.215.000	2
3 Kutub	80	A9N18365	2.382.000	1
	100	A9N18367	2.587.000	1
	125	A9N18369	3.234.000	1
4 Kutub	80	A9N18372	3.427.000	2
	100	A9N18374	3.603.000	2
	125	A9N18376	4.131.500	2

IEC 60898-1: 15 kA
IEC 60947-2: 15 kA

■ MCB C120H

- **Kurva C** (magnetis trip antara 5 dan 10 In).
- Lebar modul per kutub = 27 mm.
- Dapat digunakan untuk jaringan listrik DC
(Untuk 1 Pole hingga 144VDC, 2 Pole hingga 250VDC, 3 Pole hingga 375VDC, 4 Pole hingga 500VDC)
- Koneksi kabel ke terminal : maksimum 35 mm² kabel serabut atau 50 mm² kabel tunggal.

Jumlah kutub	Pengenal (A)	Referensi	Harga (Rp) (Sebelum PPN)	SS
2 kutub	100	A9N18458	2.581.500	2
	80	A9N18468	3.258.000	2
3 kutub	100	A9N18469	3.584.000	2
	125	A9N18470	4.546.000	2
4 kutub	100	A9N18480	4.937.000	2
	125	A9N18481	5.685.000	2

Catatan : Aksesori [lihat halaman 5-21](#)

Miniature Circuit Breaker (MCB) NG125L

IEC 60947-2 : 50 kA

■ MCB NG125L

Didesain khusus untuk aplikasi yang membutuhkan kapasitas pemutusan yang tinggi (50kA).

- Kapasitas pemutusan Icu = 50 kA - 240 / 415 VAC, memenuhi standar IEC 60947-2.
- **Kurva C** (magnetis trip antara 5 dan 10 In).
- Lebar modul per kutub = 27 mm.
- Dapat digunakan untuk jaringan listrik DC
(Untuk 1 Pole hingga 144VDC, 2 Pole hingga 250VDC, 3 Pole hingga 375VDC, 4 Pole hingga 500VDC)
- Cocok untuk aplikasi gedung komersil dan industri.



MCB NG125L
2 Kutub



MCB NG125L
3 Kutub

Jumlah kutub	Pengenal (A)	Referensi	Harga (Rp) <i>(Sebelum PPN)</i>	SS
2 Kutub	10	18788	2.911.500	2
	16	18789	2.911.500	2
	25	18791	2.911.500	2
	32	18792	2.911.500	2
3 Kutub	25	18802	3.810.500	2
	32	18803	3.769.500	2
	63	18806	3.921.500	2
	80	18807	5.045.000	2
4 Kutub	25	18813	5.546.500	2
	32	18814	5.546.500	2

Miniature Circuit Breaker (MCB) Acti 9 C60H-DC (Aplikasi DC)

IEC 60947-2: 10 kA

■ MCB C60H-DC

Direkomendasikan untuk digunakan pada distribusi listrik di gedung dan industri.

- **Kurva C** (magnetis trip antara 5 dan 10 In)
- Lebar modul per kutub = 18 mm
- Breaking Capacity (Icu):
 - 1 Kutub = 20kA di 110VDC, 10kA di 220VDC
 - 2 Kutub (seri) = 20kA di 220VDC, 10kA di 440VDC
- Cocok untuk aplikasi :
 - Gedung komersial dan industri
 - Power supply: otomasi industri, sirkuit auxiliary untuk tegangan menengah, pengisian daya baterai dan UPS, keamanan sistem daya (power system) aplikasi telekomunikasi.
 - Transportasi : kereta api, kendaraan listrik, aplikasi kapal laut.
 - Pembangkit Listrik : tenaga surya (photovoltaic), angin, nuklir.



MCB C60H-DC
1 Kutub



MCB C60H-DC
2 Kutub

Jumlah kutub	Pengenal (A)	Referensi	Harga (Rp) <i>(Sebelum PPN)</i>	SS
1 Kutub	1	A9N61501	580.500	2
	2	A9N61502	580.500	2
	4	A9N61504	580.500	2
	6	A9N61506	562.500	2
	10	A9N61508	589.500	2
	16	A9N61511	602.500	2
	20	A9N61512	604.500	2
	25	A9N61513	1.078.000	2
	32	A9N61515	1.078.000	2
	63	A9N61519	1.152.000	2
2 Kutub	2	A9N61522	1.432.000	2
	4	A9N61524	1.634.500	2
	6	A9N61526	1.634.500	1
	10	A9N61528	1.714.000	1
	16	A9N61531	1.732.500	2
	20	A9N61532	1.737.500	2
	25	A9N61533	1.772.500	2
	32	A9N61535	2.156.000	2
	40	A9N61537	2.156.000	2
	50	A9N61538	2.207.500	2
63	A9N61539	2.220.500	2	



VisiTrip & VisiSafe



ELCB iID
2 Kutub



ELCB iID
4 Kutub

Pengaman Arus Bocor

Acti 9 RCCB / ELCB iID dengan Indikator Pengaman (VisiTrip & VisiSafe)

■ RCCB (Residual Current Circuit Breaker) iID

- Pemutus tenaga arus bocor tanpa pengaman arus lebih.
- Penunjukan trip (Trip Indicator) VisiTrip
- **10 mA** untuk pengamanan dengan tingkat sensitivitas tinggi
- **30 mA** untuk pengamanan terhadap manusia (kontak langsung).
- **300 mA** untuk pengamanan terhadap bahaya api dan kontak tidak langsung.
- **Type AC**
- Standar SNI 04-6956.2.1-2005

Sensitivitas	Kutub	Pengenal (A)	Referensi	Harga (Rp) (Sebelum PPN)	SS
10 mA	2	16	A9R10216	1.573.500	1
		25	A9R10225	1.507.000	2
30 mA	2	25	A9R71225	972.500	1
		40	A9R71240	1.068.500	1
		63	A9R71263	1.653.500	1
	4	25	A9R71425	1.555.500	1
		40	A9R71440	1.709.000	1
		63	A9R71463	2.643.000	1
300 mA	2	25	A9R74225	1.021.000	1
		40	A9R74240	1.122.000	1
		63	A9R74263	1.683.000	2
		80	A9R14280	2.726.000	2
	4	100	A9R14291	3.278.000	2
		25	A9R74425	1.633.500	1
		40	A9R74440	1.795.000	1
		63	A9R74463	2.154.000	1
		80	A9R14480	3.589.500	2
		100	A9R14491	4.307.500	1

Catatan : Waktu tanggap RCCB iID terhadap terjadinya arus bocor

Arus Bocor	Waktu Tanggap
$< I_{\delta n} / 2$	Tidak Tripping
$I_{\delta n} / 2 - I_{\delta n}$	300ms
$2 I_{\delta n}$	150ms
$5 I_{\delta n}$	40ms

Contoh:

Pada RCCB iID sensitivitas 30mA, jika terjadi arus bocor hingga $I_{\delta} / 2$ (0-14mA), maka RCCB iID belum akan trip. Jika terjadi arus bocor dari $I_{\delta} / 2$ sampai I_{δ} (15-30mA), RCCB iID akan trip dalam waktu 300ms.



VisiTrip & VisiSafe



iDPN N Vigi
1P+N

Pengaman Arus Bocor

Acti 9 iDPN N Vigi / RCBO dengan Indikator Pengaman (VisiTrip & VisiSafe)

RCBO iDPN N Vigi

Pengaman sirkit secara individu

- Pemutus tenaga arus bocor dengan pengaman beban lebih dan hubung singkat.
- **30 mA** untuk pengaman terhadap manusia (kontak langsung).
- **300 mA** untuk pengaman terhadap bahaya api dan kontak tidak langsung.
- 1 kutub + netral
- **Kurva C**, dengan magnetis trip antara 5 dan 10 In.
- Kapasitas pemutusan :
 - Standar EN 60898 / EN 61009, Icn = **6kA**

Sensitivitas	Pengenal (A)	Referensi	Harga (Rp) <i>(Sebelum PPN)</i>	SS
30 mA	6	A9D31606	1.718.500	1
	10	A9D31610	1.718.500	1
	16	A9D31616	1.718.500	1
	20	A9D31620	1.718.500	1
	25	A9D31625	1.839.000	1
	32	A9D31632	1.976.500	1
	40	A9D31640	1.976.500	2
300 mA	6	A9D41606	1.783.500	1
	10	A9D41610	1.783.500	2
	16	A9D41616	1.783.500	1
	20	A9D41620	1.783.500	1
	25	A9D41625	1.933.500	2
	32	A9D41632	1.933.500	2
	40	A9D41640	1.933.500	2

Pengaman Arus Bocor

Dikombinasikan dengan Acti 9 iC60 dan C120



Modul Vigi

- Sangat direkomendasikan apabila :
 - Arus hubung singkat tinggi terjadi pada instalasi.
 - Fungsi pengaman grup sirkuit dilakukan oleh MCB.
- Tambahan pengaman arus bocor untuk iC60 dan C120.
- Kapasitas pemutusan tergantung dari MCB.
- Mudah diinstalasi.
- 30 mA untuk pengaman terhadap manusia (kontak langsung).
- 300 mA untuk pengaman terhadap bahaya api dan kontak tidak langsung.

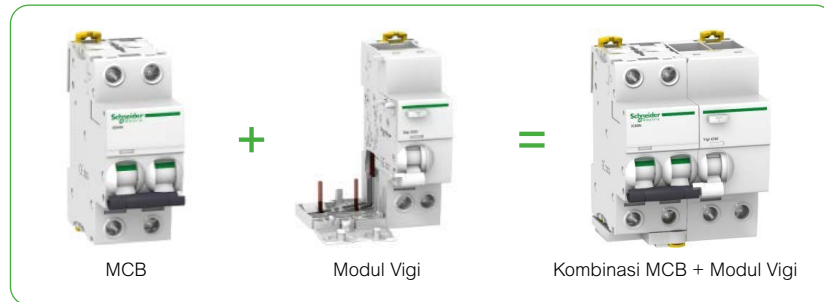

Tipe MCB	Pengenal (A)	Sensitivitas	Kutub	Referensi	Harga (Rp) (Sebelum PPN)	SS
iC60	25A	30 mA	2	A9V41225	1.289.500	2
			3	A9V41325	1.802.500	2
			4	A9V41425	2.127.500	2
		300 mA	2	A9V44225	1.160.500	2
			3	A9V44325	1.629.500	2
			4	A9V44425	1.914.500	2
	63A	30 mA	2	A9V41263	2.011.000	2
			3	A9V41363	2.715.000	2
			4	A9V41463	3.318.500	2
		300 mA	3	A9V44363	2.443.500	2
			4	A9V44463	2.986.500	2
			4	A9V15463	3.318.500	2
C120	125A	30 mA	4	A9N18569	6.381.500	2
		300 mA	3	A9N18567	4.699.000	2
			4	A9N18570	5.743.000	2

Catatan :

- Waktu tunda (*delay*) Vigi tipe selektif (s) terhadap terjadinya arus bocor

Arus Bocor	Waktu Tunda	Waktu Tanggap
$I_{\Delta n}/2 - I_{\Delta n}$	130ms	500ms
$2 I_{\Delta n}$	60ms	200ms
$5 I_{\Delta n}$	50ms	150ms

- Waktu Tanggap adalah waktu antara terjadinya arus bocor dan pemutusan arus listrik.
- Vigi dengan waktu tunda sangat berguna untuk koordinasi antar RCCB dan menghindari *nuisance tripping*.

Command Control Kontaktor Acti9 (iCT)

■ Kontaktor "DIN"

Tipe	Pengenal	Kontak	Tegangan	Lebar 9mm Mod	Referensi	Harga (Rp) (Sebelum PPN)	SS	
iCT	16A	1NO	240V	2	A9C22711	282.500	1	
		1NC+1NO	240V	2	A9C22715	433.500	1	
	25A		2NO	240V	2	A9C22712	374.000	1
			1NO	240V	2	A9C20731	292.000	1
			2NO	240V	2	A9C20732	365.000	1
			2NC	240V	2	A9C20736	695.500	2
			3NO	240V	4	A9C20833	708.000	2
			4NO	240V	4	A9C20834	836.000	2
	40A		4NC	240V	4	A9C20837	1.228.000	2
			2NC+2NO	240V	4	A9C20838	1.166.500	2
			2NO	240V	4	A9C20842	1.010.500	2
			3NO	240V	6	A9C20843	1.292.000	2
			4NO	240V	6	A9C20844	1.246.000	2
			4NC	240V	6	A9C20847	1.959.000	2
	63A		2NO	240V	4	A9C20862	1.528.000	2
			4NO	240V	6	A9C20864	1.764.000	2
	100A		4NC	240V	6	A9C20867	1.922.500	1
			2NO	240V	6	A9C20882	2.450.000	2

Catatan : Spacer A9A27062 dibutuhkan untuk pemasangan beberapa kontaktor secara bersamaan.

Tipe	Deskripsi	Tegangan Kontrol	Lebar 9mm Mod	Referensi	Harga (Rp) (Sebelum PPN)	SS
iACTs	Aux contact 5A (1A DC) 1NO + 1NC	24-240VAC / 24-130VDC	1	A9C15914	928.500	2
	Aux contact 5A (1A DC) 2NO	24-240VAC / 24-130VDC	1	A9C15916	719.000	2
	Spacer 9mm (bag x5)		1	A9A27062	243.500	2



Kontaktor "DIN"



Auxiliary iACTs

MCB Box

Mini Pragma (Pintu Transparan dan Putih)

Mini Pragma

- Desain yang sangat menarik sangat cocok untuk hotel, apartemen, rumah, dll.
- Material isolasi dapat padam sendiri.
- Sesuai dengan standard IEC 60439-3 (EN 60-439-3).
 - Tingkat proteksi sesuai dengan IEC 60529 : IP 40, IP 41, dengan aksesoris.
 - Tingkat proteksi terhadap kekuatan mekanis sesuai dengan EN 50-102 : IK 07.
 - Kelas 2 : isolasi total.
 - Ketahanan terhadap api dan panas sesuai dengan IEC 60695-2-1.
- Disuplai dengan
 - 2 penyangga terminal blok.
 - 2 terminal blok : 4 lubang untuk boks panel 4 dan 6 modul.
8 lubang untuk boks panel 8 dan 12 modul.
 - Plat penutup : 2 modul untuk boks panel 4, 6, 8.
4 modul untuk boks panel 12.
 - 1 set label penandaan, tersedia di Aksesoris.
 - 4 sekrup untuk pemasangan permukaan.

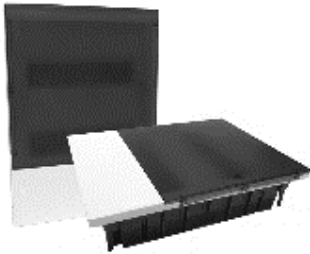

Mini Pragma
Pintu Transparan

■ Pintu Transparan

Tipe	Jumlah Baris	Kapasitas dalam Modul 18 mm	Dimensi (mm)			Referensi	Harga (Rp) (Sebelum PPN)	SS
			T	L	Tb			
Pasangan tertanam (Inbow)	1	4	252	150	98	MIP22104S	561.500	2
	1	6	252	186	98	MIP22106S	650.500	2
	1	8	252	222	98	MIP22108S	705.000	2
	1	12	252	294	98	MIP22112S	601.500	2
	1	18	252	402	98	MIP22118S	679.000	2
	2	24	377	294	98	MIP22212S	773.500	2
	3	36	502	294	98	MIP22312S	1.133.500	2



Mini Pragma
Pintu Biasa Inbow

■ Pintu Putih

Tipe	Jumlah Baris	Kapasitas dalam Modul 18 mm	Dimensi (mm)			Referensi	Harga (Rp) (Sebelum PPN)	SS
			T	L	Tb			
Pasangan permukaan (Outbow)	1	4	198	124	95	MIP12104	341.000	2
	1	6	198	160	95	MIP12106	349.000	2
	1	8	228	196	101.5	MIP12108	423.000	2
	1	12	228	268	101.5	MIP12112	575.500	2
	1	18	228	376	101.5	MIP12118	739.500	2
	2	24	353	268	102	MIP12212	703.500	2
	3	36	478	267	102	MIP12312	1.242.000	2
Pasangan tertanam (Inbow)	1	4	252	150	98	MIP22104	386.000	2
	1	6	252	186	98	MIP22106	426.000	2
	1	8	252	222	98	MIP22108	461.000	2
	1	12	252	294	98	MIP22112	547.500	2
	1	18	252	402	98	MIP22118	683.500	2
	2	24	377	294	98	MIP22212	733.500	2
	3	36	502	294	98	MIP22312	1.000.500	2

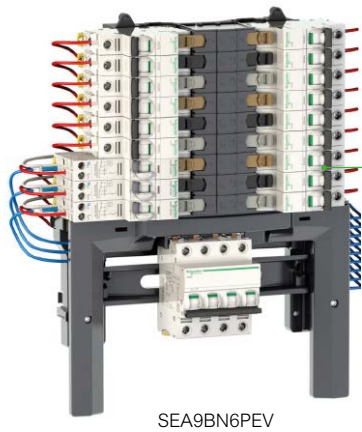

SEA9BN6PEV

Isobar

■ Isobar

- Isobar adalah panel vertikal berbentuk tulang ikan (*fishbone*) dengan pemasangan MCB/ELCB/RCBO secara horizontal.
- Pemasangan MCB/ELCB/RCBO pada isobar tidak memerlukan kabel, cukup pasang (*plug on*) dan dikencangkan.
- Untuk ELCB dan RCBO, memerlukan tambahan Aksesori.

Deskripsi	Referensi	Harga (Rp) (Sebelum PPN)	SS
Isobar			
Isobar 6 way	SEA9BN6PEV	7.790.500	2
Isobar 8 way	SEA9BN8PEV	8.773.000	2
Isobar 12 way	SEA9BN12PEV	10.688.000	2
Isobar 16 way	SEA9BN16PEV	12.615.500	2
Isobar 18 way	SEA9BN18PEV	13.584.500	2
Isobar 24 way	SEA9BN24PEV	16.496.500	2

Aksesori

250 amp incoming terminal block for E/PEV	SEA9NPB250TB	1.406.000	2
MCCB/Interpact connection kit for use with SEA9NPB250TB	SEA9BINCKIT	3.262.000	2
MCCB Direct Connection Kit	SEA9BSHEV	2.205.000	2

Catatan :

Isobar 6 way = isobar untuk 6 buah MCB 3 pole (3 di kiri dan 3 di kanan), dapat digunakan untuk 6 buah MCB 3 pole, atau 18 buah MCB 1 pole.

Tipe Koneksi

	Cable Lug	MCCB Extended Link	MCCB Direct Link	RCCB/MCB
SEA9NPB250TB	☑	☑	x	x
SEA9BINCKIT	x	☑	x	x
SEA9BSHEV	x	x	☑	x

Aksesori

Aksesori MCB, RCCB ID, iDPN Vigi, iSW, RCA, ARA dan Reflex

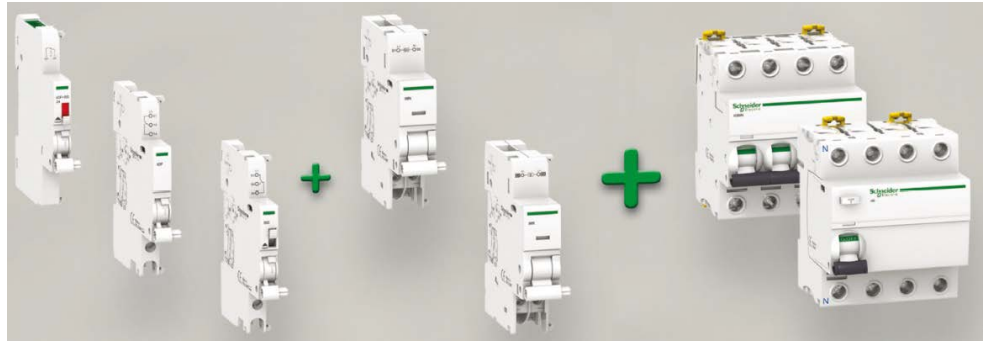

■ Kontak Bantu (Auxiliaries)

Tipe	VAC	VDC	Rated Current	Referensi	Harga (Rp) (Sebelum PPN)	SS
Kompatibel dengan iC60, iID, iDPN Vigi, RCA dan ARA						
iOF open close aux (1C/O)	240...415	24...130	0.1... 6 A	A9A26914	618.000	2
iSD fault indication aux (1C/O)	240...415	24...130	0.1... 6 A	A9A26917	616.000	2
iOF/SD+OF aux (2C/O)	240...415	24...130	0.1... 6 A	A9A26919	774.500	2
iMX+OF Shunt release	100...415	110...130		A9A26946	982.500	2
	12...24	12...24		A9A26948	1.031.000	2
iMSN Undervoltage release	230			A9A26960	1.390.500	2
iMN Undervoltage release (0.2sec delay)	230			A9A26963	1.399.000	2
Kompatibel dengan C120, DPN, C60H-DC, SW60-DC, C60PV-DC, C60NA-DC, C60PV-DC, C60NA-DC						
iOF open close aux (1C/O)	240...415	24...130	0.1... 6 A	A9N26914	630.000	2
iSD fault indication aux (1C/O)	240...415	24...130	0.1... 6 A	A9N26917	626.500	2
iOF/SD+OF aux (2C/O)	240...415	24...130	2...100 mA	A9N26929	825.000	2
iMX+OF Shunt release	100...415	110...130		A9N26946	985.000	2
	12...24	12...24		A9N26948	870.500	2
OF	415			A9N26971	1.362.500	2



Padlock



Spacer 9mm



Rotary Handle

■ Aksesori

Tipe	Keterangan	Qty	Referensi	Harga (Rp) (Sebelum PPN)	SS
Kompatibel dengan iC60, iID, iDPN Vigi, iSW, RCA, ARA dan Reflex					
Padlock device	Padlock diameter 3...6mm	10	A9A26970	753.000	2
Spacer 9mm	Includes space for cable routing	5	A9A27062	243.500	2
Plug in base	1 per pole, plug in/out	1	A9A27003	666.500	2
Rotary Handle (for 2/3/4 pole)	Complete assembly includes black handle	1	A9A27005	2.663.500	2
	Complete assembly includes red handle	1	A9A27006	2.137.500	2



Connection Devices

Linergy Busbar Sisir s/d 100A

■ Busbar Sisir Horizontal 18 mm pitch

Deskripsi	Tipe		Jumlah Modul 18mm	Qty	Referensi	Harga (Rp) (Sebelum PPN)	SS
Busbar Sisir standar 100A (warna abu-abu)	1P	L1...	24	1	A9XPH124	451.000	2
	2P	L1L2...	12	1	A9XPH212	289.500	2
		L1L2L3...	24	1	A9XPH224	576.000	2
	3P	L1L2L3...	12	1	A9XPH312	404.000	2
L1L2L3...		24	1	A9XPH324	801.500	2	
Busbar Sisir 100A (+ Aux (warna abu-abu)	4P	NL1L2L3...	24	1	A9XPH424	983.500	2
	Aux+1P*	AuxL1...	57	1	A9XAH157	1.202.500	2
	Aux+2P*	AuxL1L2...	57	1	A9XAH257	1.310.000	2
	Aux+3P*	AuxL1L2L3...	57	1	A9XAH357	1.445.000	2

*) End Caps dibeli terpisah

■ Aksesori

Deskripsi	Tipe	Qty	Referensi	Harga (Rp) (Sebelum PPN)	SS
	1P	10	A9XPE110	116.000	2
	2P	10	A9XPE210	145.500	2
	3P	10	A9XPE310	192.500	2
Insulated connector (up to 35mm cable)		4	A9XPCM04	459.000	2



PRF1 Master



PRD1 Master



PRF1 12.5r



PRD1 25r

Surge Arrester

Surge Arrester Tipe 1 Dan Tipe 1+2

■ Surge Arrester Tipe 1

Jenis	Kutub	I imp (kA) (10/350 μ s)	Teg. Nominal (V)	Teg. Operasi Max Uc (V)	Teg. Proteksi Up (kV)	Referensi	Harga (Rp) (Sebelum PPN)	SS
PRD1 35r	1P	50	230/400	440	2,5	16649	5.979.000	2
	1P	25	230	350	1,5	16360	9.457.500	2
PRD1 Master	1P+N	25/100 N/PE	230/400	350	1,5	16361	13.045.000	2
	3P+N	25/100 N/PE	230/400	350	1,5	16363	24.912.000	2

Keterangan:

PRD = Tipe Drawout

■ Surge Arrester Tipe 1+2

Jenis	Kutub	I imp (kA) (10/350 μ s)		Teg. Nominal (V)	Teg. Operasi Max Uc (V)	Teg. Proteksi Up (kV)	Referensi	Harga (Rp) (Sebelum PPN)	SS
		Tipe 1	Tipe 2						
PRF1 12.5r	1P+N	12.5/50 N/PE	50	230	350	1,5	A9L16282	6.099.000	2
	3P	12,5	50	230/400	350	1,5	A9L16382	8.564.000	2
	3P+N	12.5/50 N/PE	50	230/400	350	1,5	A9L16482	9.259.500	2
PRD1 25r	1P+N	25	40	230	350	1,5	16330	13.199.000	2
	3P+N	25/100 N/PE	40	230/400	350	1,5	16332	20.600.000	2

Keterangan:

PRF1 12.5r = Tipe Fixed

PRD1 25r = Tipe Drawout

Surge Arrester

Acti 9 Surge Arrester Tipe 2



PF
1P+N



PF
3P+N

Surge Arrester Tipe 2, iPF (Fixed atau Monoblok)

Jenis	Kutub	I maks (kA) (8/20 μ s)	Teg. Nominal Un (V)	Teg. Operasi Max Uc (V)	Teg. Proteksi Up (kV)	Referensi	Harga (Rp) (Sebelum PPN)	SS
PF20	1P	20	230	340	1.1	A9L15691	527.500	2
	1P+N	20	230	340	1.5	A9L15692	1.196.500	2
	3P+N	20	230/400	340	1.5	A9L15693	2.189.000	2
PF40	1P	20	230	340	1.5	A9L15686	605.000	2
	1P+N	40	230	340	1.5	A9L15687	1.289.000	2
	3P	40	230/400	340	1.5	A9L15582	1.934.500	2
PF65	3P+N	40	230/400	340	1.5	A9L15688	2.411.500	2
	3P+N	65	230/400	340	1.5	A9L15586	3.617.000	2

PF●●r = surge arrester dengan kontak indikasi (dry contact)

Surge Arrester Tipe 2, iPRD (Draw Out)

Jenis	Kutub	I maks (kA) (8/20 μ s)	Teg. Nominal Un (V)	Teg. Operasi Max Uc (V)	Teg. Proteksi Up (kV)	Referensi	Harga (Rp) (Sebelum PPN)	SS
PRD8	1P+N	8	230	340	1,4	A9L08500	1.610.500	2
	3P+N	8	230/400	340	1,4	A9L08600	2.663.000	2
PRD8r	1P+N	8	230	340	1,4	A9L08501	1.841.000	2
	3P+N	8	230/400	340	1,4	A9L08601	2.929.000	2
PRD20	1P+N	20	230	340	1,4	A9L20500	1.656.000	2
	3P+N	20	230/400	340	1,4	A9L20600	2.755.500	1
PRD20r	1P+N	20	230	340	1,4	A9L20501	1.888.000	1
	3P+N	20	230/400	340	1,4	A9L20601	3.054.500	1
PRD40	1P+N	40	230	340	1,4	A9L40500	1.777.500	2
	3P+N	40	230/400	340	1,4	A9L40600	2.932.000	1
PRD40r	1P+N	40	230	340	1,4	A9L40501	1.987.500	2
	3P+N	40	230/400	340	1,4	A9L40601	3.329.000	1
PRD65r	1P	65	230	340	1,5	A9L65101	1.238.000	2
	1P+N	65	230	340	1,5	A9L65501	2.344.000	2
	3P	65	230/400	340	1,5	A9L65301	3.489.000	2
	3P+N	65	230/400	340	1,5	A9L65601	4.340.000	1

PRD●●r = surge arrester dengan kontak indikasi (dry contact)

Cartridge untuk Tipe iPRD

Cartridge	Tipe	Referensi	Harga (Rp) (Sebelum PPN)	SS
C65-340	PRD 65r	A9L65102	1.131.500	2
C 40-340	PRD 40, PRD 40r	A9L40102	814.000	2
C20-340	PRD 20, PRD 20r	A9L20102	1.112.000	2
C neutral	C neutral (semua PRD Tipe 2)	A9L00002	1.181.000	2



Cartridge



PRI

Surge Arrester

Acti 9 Surge Arrester (PRI)

■ Surge Arrester PRI

Surge Arrester PRI didesain khusus untuk memproteksi peralatan-peralatan sensitif pada jaringan telepon digital dan sistem pada jaringan data komputer. Jika terjadi gangguan, Surge Arrester PRI akan mengalihkan gangguan dalam waktu kurang dari 1 ns.

Jenis	Tingkat Proteksi (Up) V	Tegangan Nominal (V)	I maks (kA) (8/20 μ s)	Referensi	Harga (Rp) (Sebelum PPN)	SS
PRI	70	48	10	A9L16339	6.185.890	2

Command Control

Pengaman Peralatan Motor

■ RCP Relay Kontrol Fase

Mengamankan instalasi listrik akibat kehilangan salah satu fase, kesalahan urutan fase dan ketidakseimbangan beban antar ketiga fase terlalu besar.

Pengaman motor terhadap ketidakseimbangan fase dan arah putaran motor terbalik.

Kontak keluaran = 8A (Cos ϕ = 1) 250 V.

Suhu operasi = -50 °C s/d + 550 °C.



RCP

■ RCU Relay Kontrol Tegangan

Mengamankan peralatan pada instalasi terhadap tegangan yang semestinya pada sistem tak stabil.

Mengaktifkan pengisian baterai bila tegangan jatuh di bawah ambang batasnya.

Menyalakan unit generator bila tegangan suplai turun atau terputus.

Pengaman motor terhadap resiko akibat penyalaan motor terlalu lama dan rotor terkunci.



RCU

■ RCI Relay Kontrol Arus

Mengamankan peralatan pada instalasi listrik akibat adanya variasi terhadap arus yang semestinya. Dipasang sebagai tambahan terhadap pengaman motor dan sistem kontrol.

Kontak keluaran = 8A (Cos ϕ = 1) 250 V.



RCI

Type	Tegangan (V)	Waktu Tanggapan	Referensi	Harga (Rp) (Sebelum PPN)	SS
RCP	400	0,15 detik	A9E21180	2.145.500	1
RCU	230	200 mili detik	A9E21182	2.887.500	2
RCI	230	200 mili detik	A9E21181	3.179.000	2



PC Socket

Command Control

PC Socket, Fuse Carrier dan Pilot Lights

■ PC Socket (Power Socket)

- Dipasang di rel DIN, sangat berguna apabila soket harus dipasang di dalam panel.
- Memenuhi standar DIN 49440.

Tipe	Pengenal (A)	Tegangan (V)	Referensi	Harga (Rp) (Sebelum PPN)	SS
2 kutub + netral	16	230-250	A9A15310	318.000	1

■ STI (Fuse Carrier)

- Digunakan untuk proteksi sirkuit kontrol dan aplikasi khusus di industri.
- Sebagai pengaman sirkuit kontrol.

Kutub	Ukuran Sekring (mm)	Tegangan (V)	Ampere	Referensi	Harga (Rp) (Sebelum PPN)	SS
1	8.5 x 31,5	380	10A	A9N15635	135.000	1
	10.3 x 38	500	25A	A9N15636	135.000	1
1 + N	10.3 x 38	500	25A	A9N15646	227.000	2
2	10.3 x 38	500	25A	A9N15651	309.000	2
3	10.3 x 38	500	25A	A9N15656	462.000	1
3+N	8.5 x 31.5	500	10A	A9N15657	562.500	2
	10.3 x 38	500	25A	A9N15658	562.500	2



STI

■ Pilot lights LED 100k hrs

Tipe	Lebar 9 mm Mod	Warna	Referensi 12..48VAC/DC	Harga (Rp) (Sebelum PPN)	SS	Referensi 110..230VAC	Harga (Rp) (Sebelum PPN)	SS
iIL	2	Merah	A9E18330	191.000	2	A9E18320	230.000	2
		Hijau	A9E18331	191.000	2	A9E18321	230.500	2
	2	Kuning	A9E18334	191.000	2	A9E18324	230.500	2





iTL

Command Control

Acti 9 iTL Relay Impuls

■ Relay Impuls

Khusus dirancang untuk kontrol multi fungsi atau remote control sirkuit melalui perintah impuls misalnya kontrol sistem penerangan (*Lighting control*)

Operation

Proses *Closing* dari relay impuls dipicu oleh impuls pada koil.

Dengan dua posisi mekanik yang stabil, kutub-kutub akan dibuka oleh impuls selanjutnya.

Tiap impuls yang diterima oleh koil, membuat posisi kutub-kutub berbalik (reverse the coil).

- Kontrol Manual pada bagian muka :
- Langsung dan kontrol manual (tergantung) prioritas dengan menggunakan O-I toggle.
- Pemutusan jarak jauh dengan selector switch.
- Indikasi: mekanikal pada bagian muka dengan menggunakan posisi toggle.

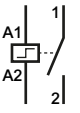
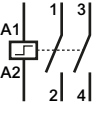
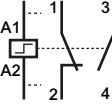
Type	Lebar 9 mm Mod	Pengenal A	Kontak	Tegangan Koil		Referensi	Harga (Rp) (Sebelum PPN)	SS
				VAC	VDC			
iTL 	2	16	1NO	240	110	A9C30811	347.000	1
iTL 	2	16	2NO	240	110	A9C30812	630.500	2
	2	16	2NO	48	24	A9C30212	616.000	2
iTLI 	2	16	1NC+1NO	240	110	A9C30815	637.500	1
	2	16	1NC+1NO	24	12	A9C30115	625.000	2



Command Control

Control Switches & Disconnection

Control Switches

Tipe	Kutub	Tegangan (V)	Pengenal (A)	Referensi	Harga (Rp) (Sebelum PPN)	SS
iSW	1 kutub	250	20	A9S60120	188.500	2
	2 kutub	415	32	A9S60232	353.500	2
	3 kutub	415	32	A9S60332	564.500	2

Switch Disconnectors

Tipe	Kutub	Tegangan (V)	Pengenal (A)	Referensi	Harga (Rp) (Sebelum PPN)	SS	
iSW	1 kutub	250	40	A9S65140	292.500	2	
	2 kutub	415	100	A9S65291	1.583.500	2	
			40	A9S65340	828.000	2	
	3 kutub	415	63	A9S65363	804.000	2	
			100	A9S65391	1.836.000	2	
			125	A9S65392	2.249.500	2	
	4 kutub	415	40	A9S65440	1.149.000	2	
			125	A9S65492	3.247.500	2	
	Auxiliary switch to suit Switch disconnectors		1C/O		A9A26904	186.500	2

Selectors Switches

Tipe	Positions	Kontak	Lebar 9 mm Mod	Arus/Teg	Referensi	Harga (Rp) (Sebelum PPN)	SS
iSSW	2	1CO	2	20A/240V	A9E18070	371.000	2
	3	2CO	4	20A/240V	A9E18074	787.000	2

1 changeover switch	2 changeover switches	1 NO + 1NC	1 changeover switch	2 changeover switches
A9E18070	A9E18071	A9E18072	A9E18073	A9E18074

Command Control

Time Delay (iRT)



RTA

Time Delay (iRT)

Fungsi dan kegunaan:

- **iRTA** menunda pengisian/energizing beban. Single time delay cycle dimulai pada saat relay power supply iRTA dihidupkan, beban terisi pada akhir time delay (T).
- **iRTB** menunda pengurasan/de-energizing beban saat penutupan kontak auxiliary (push button). Beban di de-energize pada akhir time delay (T).
- **iRTC** menunda pengurasan/de-energizing beban saat penutupan kontak auxiliary (push button). Beban di de-energize pada akhir time delay (T). Dapat melakukan restart time period tanpa perlu memutus beban.
- **iRTH** menunda pengurasan/de-energizing beban. Siklus dimulai saat power supply iRTH dihidupkan. Beban di de-energize pada akhir time delay (T).
- **iRTL** mengulang timer. Mampu melakukan siklus pengulangan yang bergantian melakukan energize & de-energize beban. Beban dihidupkan on sejak iRTL di tahap energize.
- **iRTMF** timer multifungsi, satu relay menyediakan fungsi A, B, C dan H lewat switch selector.

RTA

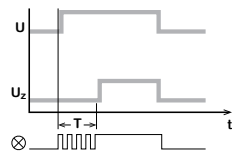

RTB

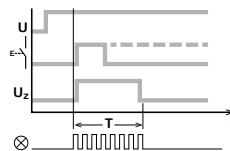

RTC

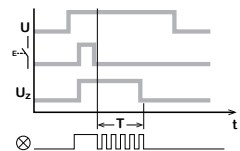

RTH

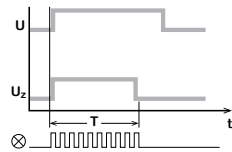

RTH

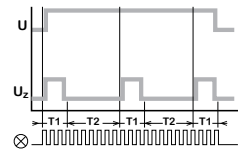

U: Supply Voltage Uz: Supply Voltage ⊗ : LED on Relay

Tipe	Kontak	Pengenal	Tegangan Koil	Referensi	Harga (Rp) (Sebelum PPN)	SS
iRTA	1C/O	8A	24VDC / 24-240VAC	A9E16065	1.884.500	2
iRTH	1C/O	8A	24VDC / 24-240VAC	A9E16068	2.827.500	2



Life Is On

Schneider
Electric

Moulded Case Circuit Breaker (MCCB)

GoPact MCCB	6-3
GoPact Molded Case Circuit Breaker 125	6-4
GoPact Molded Case Circuit Breaker 200/250/400	6-5
GoPact Molded Case Circuit Breaker 800	6-6
Internal Accessories GoMCCB	6-7
External Accessories GoMCCB	6-8
EasyPact™ CVS	6-9
EasyPact CVS Introduction	6-9
EasyPact CVS 100BS	6-10
EasyPact CVS 100A - 250A	6-11
EasyPact CVS 400A - 630A	6-12
EasyPact™ EZC	6-13
EasyPact EZC 100A 1P-2P	6-13
EasyPact EZC 100A 3P-4P	6-14
EasyPact EZC 250	6-15
EasyPact EZC 250 dengan ELCB dan EZC400-630A	6-16
Aksesori EasyPact EZC 100A	6-17
Aksesori EasyPact EZC 250A	6-18
Aksesori EasyPact EZC 400-630A	6-19
ComPacT NSXm	6-20
ComPacT NSXm Introduction	6-20
ComPacT NSXm 16 - 160A	6-21
ComPacT NSXm Vigi 16 - 160A	6-23
Aksesori ComPacT NSXm	6-24
ComPacT NSX	6-25
ComPacT NSX Direct access to Energy Efficiency	6-25
ComPacT NSX100A - 250A dengan TMD	6-29
ComPacT NSX100A - 630A dengan Micrologic	6-30
ComPacT NSX untuk Proteksi Motor	6-31
ComPacT NSX untuk Proteksi Distribusi - Arus Bocor	6-33
ComPacT NSX untuk Proteksi DC Network	6-34
Aksesori ComPacT NSX	6-35
ComPact NS	6-39
ComPact NS800 - 1600 Manually Operated	6-39
ComPact NS800 - 1600 Electrically Operated	6-40
Aksesori ComPact NS800-1600A	6-41
Source Changeover System (COS)	6-42
Source Changeover System NSX100 - NSX630	6-42
Source Changeover System NS800 - NS1600	6-43
Switch Disconnecter	6-44
ComPacT NSX-NA, NS-NA, INS	6-44
Aksesori ComPact INS	6-45
Proteksi Arus Bocor Bumi	6-46
Vigirex dan Toroida	6-46

GoPact MCCB

Robust, Simple, Compact, Standalone

GoPact MCCB

- ✓ Arus nominal sampai 800 A
- ✓ Trip unit dilengkapi dengan *thermal adjustability*
- ✓ Electronic trip unit dari 500 sampai 800 A
- ✓ Seluruh fasa dan netral terlindungi
- ✓ Plug-in base tersedia dari GoPact MCCB 200



■ Breaking capacity are at 415 V AC

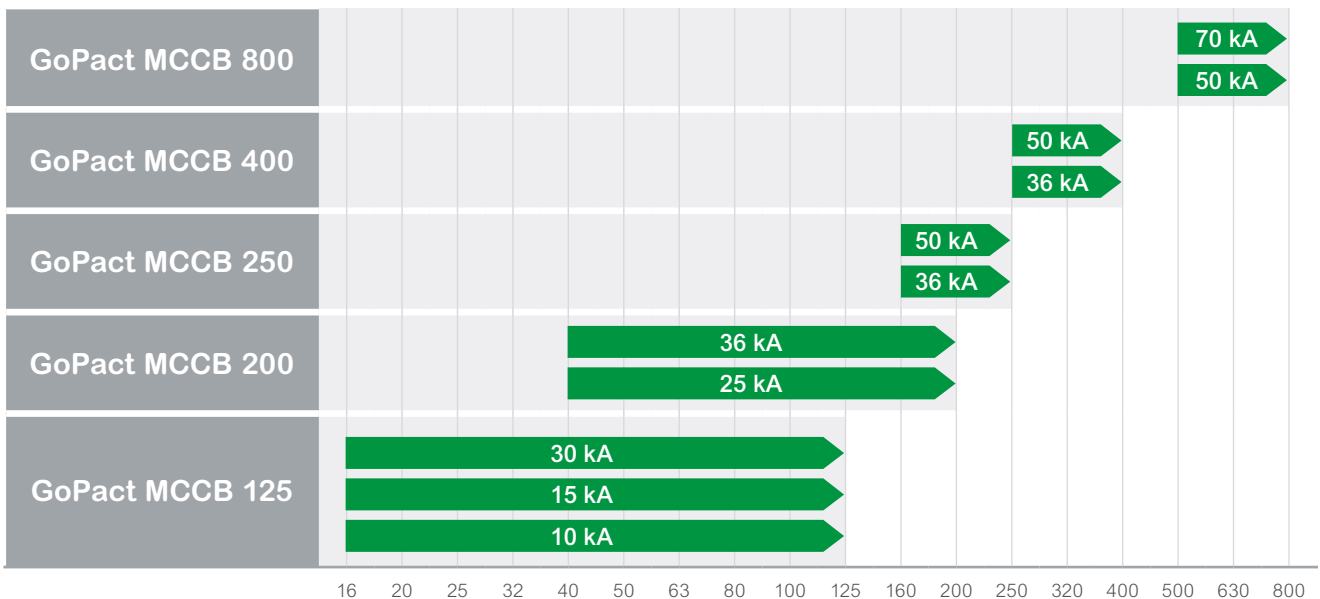

■ GoPact Molded Case Circuit Breaker 125
With thermal-magnetic trip unit TM-D

Rating	Fixed						Adjustable					
	3P 3D	Harga (Rp) (Sebelum PPN)	SS	4P 4D	Harga (Rp) (Sebelum PPN)	SS	3P 3D	Harga (Rp) (Sebelum PPN)	SS	4P 4D	Harga (Rp) (Sebelum PPN)	SS
Icu = 10 kA at 415 V AC												
16 A	G12T3F16	772.000	1 - MTS	G12T4F16	1.043.000	2 - MTO	G12T3A16	1.103.000	2 - MTO	G12T4A16	1.521.000	2 - MTO
20 A	G12T3F20	772.000	1 - MTS	G12T4F20	1.043.000	2 - MTO	G12T3A20	1.103.000	2 - MTO	G12T4A20	1.521.000	2 - MTO
25 A	G12T3F25	772.000	1 - MTS	G12T4F25	1.043.000	2 - MTO	G12T3A25	1.103.000	2 - MTO	G12T4A25	1.521.000	2 - MTO
32 A	G12T3F32	772.000	1 - MTS	G12T4F32	1.043.000	2 - MTO	G12T3A32	1.103.000	2 - MTO	G12T4A32	1.521.000	2 - MTO
40 A	G12T3F40	772.000	1 - MTS	G12T4F40	1.043.000	2 - MTO	G12T3A40	1.103.000	2 - MTO	G12T4A40	1.521.000	2 - MTO
50 A	G12T3F50	772.000	1 - MTS	G12T4F50	1.043.000	2 - MTO	G12T3A50	1.103.000	2 - MTO	G12T4A50	1.521.000	2 - MTO
63 A	G12T3F63	772.000	1 - MTS	G12T4F63	1.043.000	2 - MTO	G12T3A63	1.103.000	2 - MTO	G12T4A63	1.521.000	2 - MTO
80 A	G12T3F80	772.000	1 - MTS	G12T4F80	1.043.000	2 - MTO	G12T3A80	1.103.000	2 - MTO	G12T4A80	1.521.000	2 - MTO
100 A	G12T3F100	772.000	1 - MTS	G12T4F100	1.043.000	2 - MTO	G12T3A100	1.103.000	2 - MTO	G12T4A100	1.521.000	2 - MTO
125 A	G12T3F125	947.000	1 - MTS	G12T4F125	1.292.000	2 - MTO	G12T3A125	1.275.000	2 - MTO	G12T4A125	1.608.000	2 - MTO
Icu = 15 kA at 415 V AC												
16 A	G12E3F16	818.000	1 - MTS	G12E4F16	1.105.000	2 - MTO	G12E3A16	1.159.000	2 - MTO	G12E4A16	1.573.000	2 - MTO
20 A	G12E3F20	818.000	1 - MTS	G12E4F20	1.105.000	2 - MTO	G12E3A20	1.159.000	2 - MTO	G12E4A20	1.573.000	2 - MTO
25 A	G12E3F25	818.000	1 - MTS	G12E4F25	1.105.000	2 - MTO	G12E3A25	1.159.000	2 - MTO	G12E4A25	1.573.000	2 - MTO
32 A	G12E3F32	818.000	1 - MTS	G12E4F32	1.105.000	2 - MTO	G12E3A32	1.159.000	2 - MTO	G12E4A32	1.573.000	2 - MTO
40 A	G12E3F40	818.000	1 - MTS	G12E4F40	1.105.000	2 - MTO	G12E3A40	1.159.000	2 - MTO	G12E4A40	1.573.000	2 - MTO
50 A	G12E3F50	818.000	1 - MTS	G12E4F50	1.105.000	2 - MTO	G12E3A50	1.159.000	2 - MTO	G12E4A50	1.573.000	2 - MTO
63 A	G12E3F63	818.000	1 - MTS	G12E4F63	1.105.000	2 - MTO	G12E3A63	1.159.000	2 - MTO	G12E4A63	1.573.000	2 - MTO
80 A	G12E3F80	818.000	1 - MTS	G12E4F80	1.105.000	2 - MTO	G12E3A80	1.106.000	2 - MTO	G12E4A80	1.573.000	2 - MTO
100 A	G12E3F100	818.000	1 - MTS	G12E4F100	1.105.000	2 - MTO	G12E3A100	1.106.000	2 - MTO	G12E4A100	1.573.000	2 - MTO
125 A	G12E3F125	1.049.000	1 - MTS	G12E4F125	1.376.000	2 - MTO	G12E3A125	1.411.000	2 - MTO	G12E4A125	1.764.000	2 - MTO
Icu = 30 kA at 415 V AC												
16 A	G12F3F16	1.018.000	1 - MTS	G12F4F16	1.218.000	2 - MTO	G12F3A16	1.227.000	2 - MTO	G12F4A16	1.770.000	2 - MTO
20 A	G12F3F20	1.018.000	1 - MTS	G12F4F20	1.218.000	2 - MTO	G12F3A20	1.227.000	2 - MTO	G12F4A20	1.770.000	2 - MTO
25 A	G12F3F25	1.018.000	1 - MTS	G12F4F25	1.218.000	2 - MTO	G12F3A25	1.227.000	2 - MTO	G12F4A25	1.770.000	2 - MTO
32 A	G12F3F32	1.018.000	1 - MTS	G12F4F32	1.218.000	2 - MTO	G12F3A32	1.227.000	2 - MTO	G12F4A32	1.770.000	2 - MTO
40 A	G12F3F40	1.018.000	1 - MTS	G12F4F40	1.218.000	2 - MTO	G12F3A40	1.227.000	2 - MTO	G12F4A40	1.770.000	2 - MTO
50 A	G12F3F50	1.018.000	1 - MTS	G12F4F50	1.218.000	2 - MTO	G12F3A50	1.227.000	2 - MTO	G12F4A50	1.770.000	2 - MTO
63 A	G12F3F63	1.018.000	1 - MTS	G12F4F63	1.218.000	2 - MTO	G12F3A63	1.227.000	1 - MTS	G12F4A63	1.770.000	2 - MTO
80 A	G12F3F80	1.018.000	1 - MTS	G12F4F80	1.218.000	2 - MTO	G12F3A80	1.227.000	1 - MTS	G12F4A80	1.839.000	2 - MTO
100 A	G12F3F100	1.018.000	1 - MTS	G12F4F100	1.218.000	2 - MTO	G12F3A100	1.227.000	2 - MTO	G12F4A100	1.839.000	2 - MTO
125 A	G12F3F125	1.307.000	2 - MTO	G12F4F125	1.725.000	2 - MTO	G12F3A125	1.527.000	2 - MTO	G12F4A125	2.062.000	2 - MTO



Scan untuk Data Sheet





Scan untuk Data Sheet



GoPact MCCB

GoPact Molded Case Circuit Breaker 200/250/400

GoPact Molded Case Circuit Breaker 200

With thermal-magnetic trip unit TM-D

Rating	Adjustable					
	3P 3D	Harga (Rp) (Sebelum PPN)	SS	4P 4D	Harga (Rp) (Sebelum PPN)	SS
Icu = 25 kA at 415 V AC						
40 A	G20B3A40	1.503.000	2 - MTO	G20B4A40	1.989.000	2 - MTO
50 A	G20B3A50	1.503.000	2 - MTO	G20B4A50	1.989.000	2 - MTO
63 A	G20B3A63	1.503.000	2 - MTO	G20B4A63	1.989.000	2 - MTO
80 A	G20B3A80	1.503.000	2 - MTO	G20B4A80	1.989.000	2 - MTO
100 A	G20B3A100	1.503.000	1 - MTS	G20B4A100	1.989.000	2 - MTO
125 A	G20B3A125	1.706.000	1 - MTS	G20B4A125	2.279.000	2 - MTO
160 A	G20B3A160	1.791.000	1 - MTS	G20B4A160	2.401.000	2 - MTO
200 A	G20B3A200	1.981.000	1 - MTS	G20B4A200	2.673.000	2 - MTO
Icu = 36 kA at 415 V AC						
40 A	G20F3A40	1.595.000	2 - MTO	G20F4A40	2.162.000	2 - MTO
50 A	G20F3A50	1.595.000	2 - MTO	G20F4A50	2.162.000	2 - MTO
63 A	G20F3A63	1.595.000	2 - MTO	G20F4A63	2.162.000	2 - MTO
80 A	G20F3A80	1.595.000	2 - MTO	G20F4A80	2.162.000	2 - MTO
100 A	G20F3A100	1.595.000	2 - MTO	G20F4A100	2.162.000	2 - MTO
125 A	G20F3A125	1.829.000	1 - MTS	G20F4A125	2.478.000	2 - MTO
160 A	G20F3A160	1.934.000	1 - MTS	G20F4A160	2.864.000	2 - MTO
200 A	G20F3A200	2.153.000	1 - MTS	G20F4A200	3.160.000	2 - MTO

GoPact Molded Case Circuit Breaker 250

With thermal-magnetic trip unit TM-D



Rating	Adjustable					
	3P 3D	Harga (Rp) (Sebelum PPN)	SS	4P 4D	Harga (Rp) (Sebelum PPN)	SS
Icu = 25 kA at 415 V AC						
160 A	G25B3A160	2.299.000	2 - MTO	G25B4A160	3.034.000	2 - MTO
200 A	G25B3A200	2.369.000	2 - MTO	G25B4A200	3.104.000	2 - MTO
250 A	G25B3A250	2.369.000	1 - MTS	G25B4A250	3.104.000	2 - MTO
Icu = 36 kA at 415 V AC						
160 A	G25F3A160	2.499.000	2 - MTO	G25F4A160	3.387.000	2 - MTO
200 A	G25F3A200	2.499.000	2 - MTO	G25F4A200	3.527.000	2 - MTO
250 A	G25F3A250	2.499.000	1 - MTS	G25F4A250	3.527.000	2 - MTO

GoPact Molded Case Circuit Breaker 400

With thermal-magnetic trip unit TM-D



Rating	Adjustable					
	3P 3D	Harga (Rp) (Sebelum PPN)	SS	4P 4D	Harga (Rp) (Sebelum PPN)	SS
Icu = 36 kA at 415 V AC						
250 A	G40F3A250	4.911.000	2 - MTO	G40F4A250	6.629.000	2 - MTO
320 A	G40F3A320	4.911.000	1 - MTS	G40F4A320	6.629.000	2 - MTO
400 A	G40F3A400	4.911.000	1 - MTS	G40F4A400	6.629.000	2 - MTO
Icu = 50 kA at 415 V AC						
250 A	G40N3A250	5.598.000	2 - MTO	G40N4A250	7.557.000	2 - MTO
320 A	G40N3A320	5.598.000	2 - MTO	G40N4A320	7.557.000	2 - MTO
400 A	G40N3A400	5.598.000	2 - MTO	G40N4A400	7.557.000	2 - MTO



Scan untuk Data Sheet



GoPact MCCB

GoPact Molded Case Circuit Breaker 800

GoPact Molded Case Circuit Breaker 800

With thermal-magnetic trip unit TM-D

Rating	Adjustable					
	3P 3D	Harga (Rp) (Sebelum PPN)	SS	4P 4D	Harga (Rp) (Sebelum PPN)	SS
Icu = 50 kA at 415 V AC						
500 A	G80N3TM500	8.546.000	2 - MTO	G80N4TM500	11.538.000	2 - MTO
630 A	G80N3TM630	8.546.000	2 - MTO	G80N4TM630	11.538.000	2 - MTO
800 A	G80N3TM800	11.394.000	2 - MTO	G80N4TM800	15.660.000	2 - MTO
Icu = 70 kA at 415 V AC						
500 A	G80H3TM500	9.370.000	2 - MTO	G80H4TM500	12.418.000	2 - MTO
630 A	G80H3TM630	9.370.000	2 - MTO	G80H4TM630	12.418.000	2 - MTO
800 A	G80H3TM800	12.494.000	2 - MTO	G80H4TM800	16.558.000	2 - MTO

GoPact Molded Case Circuit Breaker 800

With Electronic trip unit ETU 2.4

Rating	Adjustable					
	3P 3D	Harga (Rp) (Sebelum PPN)	SS	4P 4D	Harga (Rp) (Sebelum PPN)	SS
Icu = 50 kA at 415 V AC						
500 A	G80N3E500	11.482.000	2 - MTO	G80N4E500	14.926.000	2 - MTO
630 A	G80N3E630	11.482.000	2 - MTO	G80N4E630	14.926.000	2 - MTO
800 A	G80N3E800	15.308.000	1 - MTS	G80N4E800	22.799.000	2 - MTO
Icu = 70 kA at 415 V AC						
500 A	G80H3E500	12.589.000	2 - MTO	G80H4E500	17.940.000	2 - MTO
630 A	G80H3E630	12.589.000	2 - MTO	G80H4E630	17.940.000	2 - MTO
800 A	G80H3E800	16.785.000	2 - MTO	G80H4E800	26.538.000	2 - MTO



Scan untuk Data Sheet



GoPact MCCB Internal Accessories

Voltage release (MN) / Shunt trip (MX)

Rating	Referensi	Harga (Rp) (Sebelum PPN)	SS
GoPact MCCB 125 AC 50/60 Hz			
	MN		
110 V	G12UVR110AC	789.000	2 - MTO
240 V	G12UVR230AC	789.000	1 - MTS
415 V	G12UVR415AC	789.000	2 - MTO

Rating	Referensi	Harga (Rp) (Sebelum PPN)	SS
GoPact MCCB 125 AC 50/60Hz			
	MX		
110-415 V	G12SHT415AC	542.000	2 - MTO

Rating	Referensi	Harga (Rp) (Sebelum PPN)	SS
GoPact MCCB 200-250 AC 50/60Hz			
	MN		
110 V	G20-25UVR110AC	902.000	2 - MTO
240 V	G20-25UVR240AC	902.000	1 - MTS
415 V	G20-25UVR415AC	902.000	2 - MTO

Rating	Referensi	Harga (Rp) (Sebelum PPN)	SS
GoPact MCCB 200-250 AC/DC 50/60Hz			
	MX		
24 V	G20-25SHT24DC	617.000	2 - MTO
48 V	G20-25SHT48DC	617.000	2 - MTO
110 V	G20-25SHT110AC	617.000	2 - MTO
240 V	G20-25SHT240AC	617.000	1 - MTS
415 V	G20-25SHT415AC	617.000	2 - MTO

Rating	Referensi	Harga (Rp) (Sebelum PPN)	SS
GoPact MCCB 400-800 AC/DC 50/60Hz			
	MN		
110 V	G40-80UVR110AC	961.000	2 - MTO
240 V	G40-80UVR240AC	961.000	2 - MTO
415 V	G40-80UVR415AC	961.000	2 - MTO

Rating	Referensi	Harga (Rp) (Sebelum PPN)	SS
GoPact MCCB 400-800 AC/DC 50/60Hz			
	MX		
24 V	G40-80SHT24DC	686.000	1 - MTS
48 V	G40-80SHT48DC	689.000	2 - MTO
110 V	G40-80SHT110AC	686.000	2 - MTO
240 V	G40-80SHT240AC	713.000	2 - MTO
415 V	G40-80SHT415AC	720.000	2 - MTO

Auxiliary contact (OF/SD)

Rating	Referensi	Harga (Rp) (Sebelum PPN)	SS
Auxiliary contact (OF/SD) GoPact MCCB 125-250			
240 V	G12-25AUX240	299.000	1 - MTS
Auxiliary contact (OF/SD) GoPact MCCB 400-800			
240 V	G40-80AUX240	334.000	2 - MTO



External Accessories



	Referensi	Harga (Rp) (Sebelum PPN)	SS	Referensi	Harga (Rp) (Sebelum PPN)	SS
Rotary Handle						
	Direct			Extended		
GoPact MCCB 125	G12ROTDS	484.000	2 - MTO	G12ROTE	837.000	2 - MTO
GoPact MCCB 200	G20ROTDS	589.000	2 - MTO	G20ROTE	1.041.000	2 - MTO
GoPact MCCB 250	G25ROTDS	620.000	2 - MTO	G25ROTE	1.095.000	2 - MTO
GoPact MCCB 400	G40ROTDS	957.000	2 - MTO	G40ROTE	1.509.000	2 - MTO
GoPact MCCB 800	G80ROTDS	1.008.000	2 - MTO	G80ROTE	1.588.000	2 - MTO
Interphase barriers set of 2						
GoPact MCCB 125	G12FASB2	50.000	2 - MTO			
GoPact MCCB 200	G20FASB2	55.000	2 - MTO			
GoPact MCCB 250	G25FASB2	74.000	2 - MTO			
GoPact MCCB 400-800	G40-80FASB2	112.000	2 - MTO			
GoPact MCCB 200 Plug In Base Insulator	G20PLUGFASB2	69.000	2 - MTO			
Short Terminal shield						
	3P			4P		
GoPact MCCB 125	G12STSHD3P	121.000	2 - MTO	G12STSHD4P	140.000	2 - MTO
GoPact MCCB 200	G20STSHD3P	131.000	2 - MTO	G20STSHD4P	157.000	2 - MTO
GoPact MCCB 250	G25STSHD3P	176.000	2 - MTO	G25STSHD4P	230.000	2 - MTO
GoPact MCCB 400	G40STSHD3P	185.000	2 - MTO	G40STSHD4P	242.000	2 - MTO
GoPact MCCB 800	G80STSHD3P	277.000	2 - MTO	G80STSHD4P	314.000	2 - MTO
Long Terminal shield						
	3P			4P		
GoPact MCCB 125	G12LTSHD3P	326.000	2 - MTO	G12LTSHD4P	366.000	2 - MTO
GoPact MCCB 200	G20LTSHD3P	344.000	2 - MTO	G20LTSHD4P	423.000	2 - MTO
GoPact MCCB 250	G25LTSHD3P	482.000	2 - MTO	G25LTSHD4P	592.000	2 - MTO
GoPact MCCB 400	G40LTSHD3P	508.000	2 - MTO	G40LTSHD4P	624.000	2 - MTO
GoPact MCCB 800	G80LTSHD3P	660.000	2 - MTO	G80LTSHD4P	810.000	2 - MTO
Plug-In Base						
	3P			4P		
GoPact MCCB 200	G20PBASE3P	2.102.000	2 - MTO	G20PBASE4P	2.724.000	2 - MTO
GoPact MCCB 250	G25PBASE3P	2.492.000	2 - MTO	G25PBASE4P	3.201.000	2 - MTO
GoPact MCCB 400	G40PBASE3P	4.011.000	2 - MTO	G40PBASE4P	4.926.000	2 - MTO
GoPact MCCB 800	G80PBASE3P	11.988.000	2 - MTO	G80PBASE4P	13.940.000	2 - MTO
Conversion kit for Plug-in Base						
	3P			4P		
GoPact MCCB 200	G20PLUGKIT3P	897.000	2 - MTO	G20PLUGKIT4P	1.109.000	2 - MTO
GoPact MCCB 250	G25PLUGKIT3P	1.128.000	2 - MTO	G25PLUGKIT4P	1.433.000	2 - MTO
GoPact MCCB 400	G40PLUGKIT3P	2.856.000	2 - MTO	G40PLUGKIT4P	3.636.000	2 - MTO
GoPact MCCB 800	G80PLUGKIT3P	6.300.000	2 - MTO	G80PLUGKIT4P	7.365.000	2 - MTO
Terminal Extension Spreaders						
	3P			4P		
GoPact MCCB 125	G12SPDR3P	388.000	2 - MTO	G12SPDR4P	517.000	2 - MTO
GoPact MCCB 160-200 A	G20SPDR3P	410.000	2 - MTO	G20SPDR4P	546.000	2 - MTO
GoPact MCCB 250	G25SPDR3P	463.000	2 - MTO	G25SPDR4P	629.000	2 - MTO
GoPact MCCB 400	G40SPDR3P	1.263.000	2 - MTO	G40SPDR4P	1.684.000	2 - MTO
GoPact MCCB 800-630 A	G80SPDR3P630	2.932.000	2 - MTO	G80SPDR4P630	3.378.000	2 - MTO
GoPact MCCB 800-800 A	G80SPDR3P800	3.722.000	2 - MTO	G80SPDR4P800	4.291.000	2 - MTO
Terminal Extension Spreaders						
	3P			4P		
GoPact MCCB 200	G20RC3P	992.000	2 - MTO	G20RC4P	1.421.000	2 - MTO
GoPact MCCB 250	G25RC3P	1.167.000	2 - MTO	G25RC4P	1.671.000	2 - MTO
GoPact MCCB 400	G40RC3P	2.040.000	2 - MTO	G40RC4P	2.808.000	2 - MTO
GoPact MCCB 800	G80RC3P	2.399.000	2 - MTO	G80RC4P	3.451.000	2 - MTO
Steel bare cable connectors						
	3P			4P		
GoPact MCCB 200*	G20SBC3P	345.000	2 - MTO	G20SBC4P	441.000	2 - MTO
GoPact MCCB 250	G25SBC3P	695.000	2 - MTO	G25SBC4P	926.000	2 - MTO
GoPact MCCB 400	G40SBC3P	904.000	2 - MTO	G40SBC4P	1.154.000	2 - MTO

*) Do not use steel bare cable connectors for 200 A

EasyPact™ CVS

Pilihan Mudah yang Berkualitas & Hemat

■ EasyPact CVS



- $I_{cs} = 100\% \times I_{cu}$
- Fault current breaking capacity 25kA to 50kA
- 16 - 250A dengan TM-D trip units
- 320 - 630A dengan TM-D dan Electronic trip units
- Tipe Proteksi:
 - Thermal-magnetik 16-600A
 - Electronic 400-630A
 - Motor duty 2.5-500A
- Mekanisme rotor rem ganda

Nilai Pelanggan



CVS adalah produk yang... **Aman**

- Sesuai untuk isolasi dengan feeding terbalik.
- Fasia depan kelas 2.



CVS adalah produk yang... **Andal**

- Rangkaian I_{cs} lengkap = $100\% \times I_{cu}$.
- Umur mekanis dan kelistrikan panjang.
- Kualitas dan layanan purna jual Schneider.
- Lintasan pendek berkesinambungan (continuous rated shunt), koil di bawah tegangan/under-voltage.



CVS adalah produk yang... **Sederhana**

- Hanya dua ukuran rangka 16 ke 630A.
- Aksesori umum dengan ComPact NSX MCCB.

Moulded Case Circuit Breaker (MCCB)

PPCCB



Scan untuk Data Sheet

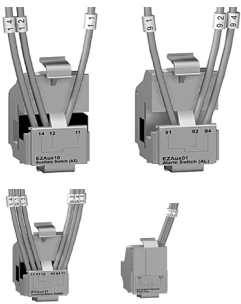

Kontak Bantu EasyPact CVS100BS

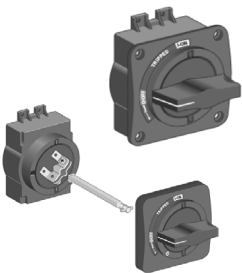

EasyPact™ CVS 100BS

Moulded Case Circuit Breaker 100A

EasyPact CVS 100BS dengan TMD

- Arus Nominal (In) : 100 A
- Kapasitas Pemutusan Icu : B (25) kA⁽²⁾
- Trip unit :
 - TMD : Thermal Magnetic (adjustable 0.8 - 1 x In)
Untuk proteksi beban distribusi.
- Fixed type, front connection.
- Memenuhi standar IEC 60947-2.

Trip Unit	Ir (A)	3P	Harga (Rp) (Sebelum PPN)	SS	4P	Harga (Rp) (Sebelum PPN)	SS
EasyPact CVS100BS (25 kA)							
TM16D	12.8-16	LV510930	1.445.000	2 - MTO			
TM25D	20.0-25	LV510932	1.445.000	2 - MTO	LV510952	1.971.000	2 - MTO
TM32D	25.6-32	LV510933	1.445.000	2 - MTO	LV510953	1.888.000	2 - MTO
TM40D	32.0-40	LV510934	1.445.000	2 - MTO	LV510954	1.888.000	2 - MTO
TM50D	40.0-50	LV510935	1.445.000	2 - MTO	LV510955	1.913.000	2 - MTO
TM63D	50.4-63	LV510936	1.461.000	2 - MTO	LV510956	2.080.000	2 - MTO
TM80D	64.0-80	LV510937	1.461.000	2 - MTO	LV510957	2.052.000	2 - MTO
TM100D	80.0-100	LV510938	1.461.000	2 - MTO	LV510958	2.080.000	2 - MTO

Kontak Bantu CVS 100BS

Kontak Bantu	Teg kontrol (V)	Referensi	Harga (Rp) (Sebelum PPN)	SS
Auxiliary Switch (AX)		EZAUX10	391.000	1 - MTS
Alarm Switch (AL)		EZAUX01	480.000	2 - MTO
Auxiliary Switch / Alarm Switch (AX/AL)		EZAUX11	781.000	1 - MTS
	100-130 VAC	EZASHT100AC	782.000	2 - MTO
Shunt Trip (SHT)	200-277 VAC	EZASHT200AC	782.000	1 - MTS
	380-480 VAC	EZASHT380AC	949.000	2 - MTO
	24 VDC	EZASHT024DC	1.086.000	2 - MTO
Under Voltage Release (UVR)	200-240 VAC	EZAUVR200AC	2.217.000	2 - MTO

Aksesori Rotary Handle untuk CVS 100BS

Aksesori	Qty	Referensi	Harga (Rp) (Sebelum PPN)	SS
Rotary handle				
Direct rotary handle		EZAROTDS	869.000	2 - MTO
Extended rotary handle		EZAROTE	1.261.000	2 - MTO

Dimension

EasyPact CVS100 BS		EasyPact CVS100 B/F/N	
H: 130 mm	W: 75 (3P); 100 (4P) mm	H: 161 mm	W: 105 (3P); 140 (4P) mm
D: 60 mm		D: 86 mm	

Catatan :

- (1) Ics = Service Breaking Capacity, Icu = Ultimate Breaking Capacity.
 (2) Ics = 17kA



Scan untuk Data Sheet



EasyPact™ CVS Moulded Case Circuit Breaker 100A s/d 250A

EasyPact CVS 100/160/250 B/F/N dengan TMD

- Arus Nominal (In) : 100 A/160 A/250 A
- Kapasitas Pemutusan : B (25), F(36) dan N (50) kA pada 380/415 VAC.
- Ics = 100% Icu.⁽¹⁾
- Trip unit :
 - TMD : Thermal Magnetic (adjustable 0.7 - 1 x In)
Untuk proteksi beban distribusi.
- Fixed type, front connection.
- Memenuhi standar IEC 60947-2.

Trip Unit	Ir (A)	Im (A)	3P	Harga (Rp) (Sebelum PPN)	SS	4P	Harga (Rp) (Sebelum PPN)	SS
EasyPact CVS100-250 B (25 kA)								
TM16D	11.2-16	190	LV510300	1.570.000	1 - MTS	LV510310	2.056.000	1 - MTS
TM25D	17.5-25	300	LV510301	1.570.000	1 - MTS	LV510311	2.056.000	1 - MTS
TM32D	22.4-32	400	LV510302	1.570.000	1 - MTS	LV510312	2.056.000	1 - MTS
TM40D	28-40	500	LV510303	1.570.000	1 - MTS	LV510313	2.056.000	1 - MTS
TM50D	35-50	500	LV510304	1.570.000	1 - MTS	LV510314	2.056.000	1 - MTS
TM63D	44.1-63	500	LV510305	1.570.000	1 - MTS	LV510315	2.234.000	1 - MTS
TM80D	56-80	640	LV510306	1.570.000	1 - MTS	LV510316	2.234.000	1 - MTS
TM100D	70-100	800	LV510307	1.570.000	1 - MTS	LV510317	2.234.000	1 - MTS
TM125D	87.5-125	1250	LV516302	2.248.000	1 - MTS	LV516312	2.925.000	1 - MTS
TM160D	112-160	1250	LV516303	2.611.000	1 - MTS	LV516313	3.396.000	1 - MTS
TM200D	140-200	2000	LV525302	2.921.000	1 - MTS	LV525312	3.664.000	1 - MTS
TM250D	175-250	2500	LV525303	3.005.000	1 - MTS	LV525313	3.771.000	1 - MTS
EasyPact CVS100-250 F (36 kA)								
TM16D	11.2-16	190	LV510330	1.705.000	1 - MTS	LV510340	2.263.000	2 - MTO
TM25D	17.5-25	300	LV510331	1.705.000	1 - MTS	LV510341	2.263.000	2 - MTO
TM32D	22.4-32	400	LV510332	1.705.000	1 - MTS	LV510342	2.263.000	2 - MTO
TM40D	28-40	500	LV510333	1.705.000	1 - MTS	LV510343	2.263.000	2 - MTO
TM50D	35-50	500	LV510334	1.705.000	1 - MTS	LV510344	2.263.000	2 - MTO
TM63D	44.1-63	500	LV510335	1.728.000	1 - MTS	LV510345	2.328.000	1 - MTS
TM80D	56-80	640	LV510336	1.728.000	1 - MTS	LV510346	2.328.000	1 - MTS
TM100D	70-100	800	LV510337	1.728.000	1 - MTS	LV510347	2.328.000	1 - MTS
TM125D	87.5-125	1250	LV516332	2.472.000	1 - MTS	LV516342	2.991.000	2 - MTO
TM160D	112-160	1250	LV516333	2.955.000	1 - MTS	LV516343	3.543.000	2 - MTO
TM200D	140-200	2000	LV525332	3.718.000	1 - MTS	LV525342	4.664.000	2 - MTO
TM250D	175-250	2500	LV525333	3.829.000	1 - MTS	LV525343	4.808.000	1 - MTS
EasyPact CVS100-250 N (50 kA)								
TM16D	11.2-16	190	LV510470	2.400.000	2 - MTO	LV510480	3.233.000	2 - MTO
TM25D	17.5-25	300	LV510471	2.400.000	1 - MTS	LV510481	3.233.000	2 - MTO
TM32D	22.4-32	400	LV510472	2.400.000	1 - MTS	LV510482	3.139.000	2 - MTO
TM40D	28-40	500	LV510473	2.400.000	1 - MTS	LV510483	3.233.000	2 - MTO
TM50D	35-50	500	LV510474	2.400.000	2 - MTO	LV510484	3.233.000	2 - MTO
TM63D	44.1-63	500	LV510475	2.472.000	1 - MTS	LV510485	3.332.000	2 - MTO
TM80D	56-80	640	LV510476	2.472.000	2 - MTO	LV510486	3.235.000	2 - MTO
TM100D	70-100	800	LV510477	2.472.000	1 - MTS	LV510487	3.332.000	2 - MTO
TM125D	87.5-125	1250	LV516462	3.330.000	1 - MTS	LV516467	4.331.000	2 - MTO
TM160D	112-160	1250	LV516463	3.977.000	1 - MTS	LV516468	5.176.000	2 - MTO
TM200D	140-200	2000	LV525452	4.852.000	1 - MTS	LV525457	5.963.000	2 - MTO
TM250D	175-250	2500	LV525453	4.852.000	1 - MTS	LV525458	5.963.000	2 - MTO

Catatan:

- (1) Ics = Service Breaking Capacity, Icu = Ultimate Breaking Capacity.
- Untuk aksesoris, bisa mengacu pada [halaman 6-35](#) sampai [6-38](#)



Scan untuk Data Sheet



EasyPact CVS 400/630



EasyPact CVS 400/630

EasyPact™ CVS

Moulded Case Circuit Breaker 400A s/d 630A

EasyPact CVS 400/630 F/N/H dengan TMD

- Arus Nominal (In) : 400A / 630A
- Kapasitas Pemutusan : 36 kA s/d 70 kA pada 380/415 VAC.
- Ics = 100% Icu.⁽¹⁾
- Trip unit :
 - TMD : Thermal Magnetic (adjustable 0.7 - 1 x In)
Untuk proteksi beban distribusi.
- Fixed type, front connection.
- Memenuhi standar IEC 60947-2.

⚠️ TM600D akan diskontinyu dan digantikan dengan TM630D

Trip Unit	Ir (A)	Im (A)	3P	Harga (Rp) (Sebelum PPN)	SS	4P	Harga (Rp) (Sebelum PPN)	SS
EasyPact CVS400-630 F (36 kA)								
TM320D	224-320	5-10 In	LV540305	5.074.000	1 - MTS	LV540308	6.690.000	1 - MTS
TM400D	280-400	5-10 In	LV540306	5.487.000	1 - MTS	LV540309	6.887.000	1 - MTS
TM500D	350-500	4.2-8.3 In	LV563305	8.855.000	1 - MTS	LV563308	10.623.000	2 - MTO
TM600D	420-600	4.2-8.3 In	LV563306	9.741.000	1 - MTS	LV563309	11.686.000	2 - MTO
TM630D	441-630	4.2-8.3 In	LV563307	10.033.000	2 - MTO	LV563310	12.037.000	2 - MTO
EasyPact CVS400-630 N (50 kA)								
TM320D	224-320	5-10 In	LV540315	5.981.000	1 - MTS	LV540318	7.508.000	2 - MTO
TM400D	280-400	5-10 In	LV540316	6.470.000	1 - MTS	LV540319	8.120.000	1 - MTS
TM500D	350-500	4.2-8.3 In	LV563315	10.173.000	1 - MTS	LV563318	12.209.000	1 - MTS
TM600D	420-600	4.2-8.3 In	LV563316	11.190.000	1 - MTS	LV563319	13.429.000	2 - MTO
TM630D	441-630	4.2-8.3 In	LV563317	11.526.000	2 - MTO	LV563320	13.831.000	2 - MTO
EasyPact CVS400-630 H (70 kA)								
TM320D	224-320	5-10 In	LV540325	6.529.000	2 - MTO	LV540328	8.196.000	2 - MTO
TM400D	280-400	5-10 In	LV540326	7.065.000	2 - MTO	LV540329	8.866.000	2 - MTO
TM500D	350-500	4.2-8.3 In	LV563325	17.928.000	2 - MTO	LV563328	24.488.000	2 - MTO
TM600D	420-600	4.2-8.3 In	LV563326	17.910.000	2 - MTO	LV563329	24.457.000	2 - MTO
TM630D	441-630	4.2-8.3 In	LV563327	18.448.000	2 - MTO	LV563330	20.293.000	2 - MTO

EasyPact CVS 400/630 F/N/H dengan Electronic ETS 2.3

- Arus Nominal (In) : 400A / 630A
- Kapasitas Pemutusan : 36 kA s/d 70 kA pada 380/415 VAC.
- Ics = 100% Icu.⁽¹⁾
- Inbuilt Thermal memory
- Trip unit :
 - ETS 2.3 : Electronic trip unit dengan proteksi LSol untuk beban distribusi.
- Fixed type, front connection.
- Memenuhi standar IEC 60947-2.

Trip Unit	Ir (A)	Im (A)	3P	Harga (Rp) (Sebelum PPN)	SS	4P	Harga (Rp) (Sebelum PPN)	SS
EasyPact CVS400-630 F (36 kA)								
ETS 400	200-400	2-10 In	LV540505	8.385.000	2 - MTO	LV540506	10.097.000	2 - MTO
ETS 630	315-630	2-10 In	LV563505	12.995.000	1 - MTS	LV563506	17.829.000	2 - MTO
EasyPact CVS400N/630 N (50 kA)								
ETS 400	200-400	2-10 In	LV540510	10.941.000	2 - MTO	LV540511	13.575.000	2 - MTO
ETS 630	315-630	2-10 In	LV563510	14.987.000	2 - MTO	LV563511	19.414.000	2 - MTO
EasyPact CVS400N/630 H (70 kA)								
ETS 400	200-400	2-10 In	LV540515	14.276.000	2 - MTO	LV540516	15.655.000	2 - MTO
ETS 630	315-630	2-10 In	LV563515	17.284.000	2 - MTO	LV563516	19.414.000	2 - MTO

⁽¹⁾ Ics = Service Breaking Capacity, Icu = Ultimate Breaking Capacity.
 ■ Untuk aksesoris, bisa mengacu pada [halaman 6-35](#) sampai [6-38](#)



Scan untuk Data Sheet



EasyPact 100, 1P



EasyPact 100, 2P

EasyPact™ Ezc

Moulded Case Circuit Breaker 100A 1P/2P

■ EasyPact Ezc100 N/H dengan 1P/2P

- Aplikasi untuk instalasi listrik dengan kapasitas pemutusan rendah.
- Kapasitas Pemutusan : 18 kA s/d 25 kA pada 220/240 VAC.
- Thermal magnetic trip unit, tidak dapat disetel (*non adjustable*).
- Fixed type, front connection.
- Satu ukuran (*frame size*) untuk semua rating.
- Memenuhi standar IEC 60947-2.
- Rated @ 125V DC (1P) dan @ 250V DC (2P in series)

EasyPact	Ir (A)	1P	Harga (Rp) (Sebelum PPN)	SS	2P	Harga (Rp) (Sebelum PPN)	SS
EasyPact Ezc100N 1P (18 kA @220/240V AC / 5 kA @125V DC)							
Ezc100N	15	Ezc100N1015	549.000	2 - MTO			
Ezc100N	20	Ezc100N1020	549.000	2 - MTO			
Ezc100N	25	Ezc100N1025	549.000	2 - MTO			
Ezc100N	30	Ezc100N1030	549.000	2 - MTO			
Ezc100N	40	Ezc100N1040	549.000	2 - MTO			
Ezc100N	50	Ezc100N1050	549.000	2 - MTO			
Ezc100N	60	Ezc100N1060	645.000	2 - MTO			
Ezc100N	75	Ezc100N1075	645.000	2 - MTO			
Ezc100N	80	Ezc100N1080	645.000	1 - MTS			
Ezc100N	100	Ezc100N1100	645.000	1 - MTS			
EasyPact Ezc100H 1P (25 kA @220/240V AC / 10 kA@125V DC); 2P (100 kA @220/240V / 10 kA@250V DC)							
Ezc100H	15	Ezc100H1015	762.000	2 - MTO	Ezc100H2015	1.201.000	2 - MTO
Ezc100H	20	Ezc100H1020	762.000	2 - MTO	Ezc100H2020	1.201.000	2 - MTO
Ezc100H	25	Ezc100H1025	762.000	2 - MTO	Ezc100H2025	1.201.000	2 - MTO
Ezc100H	30	Ezc100H1030	762.000	2 - MTO	Ezc100H2030	1.201.000	2 - MTO
Ezc100H	40	Ezc100H1040	762.000	2 - MTO	Ezc100H2040	1.201.000	2 - MTO
Ezc100H	50	Ezc100H1050	807.000	2 - MTO	Ezc100H2050	1.201.000	2 - MTO
Ezc100H	60	Ezc100H1060	762.000	2 - MTO	Ezc100H2060	1.201.000	2 - MTO
Ezc100H	75	Ezc100H1075	762.000	2 - MTO	Ezc100H2075	1.201.000	2 - MTO
Ezc100H	80	Ezc100H1080	762.000	2 - MTO	Ezc100H2080	1.201.000	2 - MTO
Ezc100H	100	Ezc100H1100	807.000	2 - MTO	Ezc100H2100	1.201.000	2 - MTO



Scan untuk Data Sheet

EasyPact™ Ezc

Moulded Case Circuit Breaker 100A 3P/4P

■ EasyPact Ezc100 B/F/N/H dengan 3P/4P

- Aplikasi untuk instalasi listrik dengan kapasitas pemutusan rendah.
- Kapasitas Pemutusan : 7.5 kA s/d 30 kA pada 380/415 VAC.
- Thermal magnetic trip unit, tidak dapat disetel (*non adjustable*).
- Fixed type, front connection.
- Satu ukuran (*frame size*) untuk semua rating.
- Memenuhi standar IEC 60947-2.
- Rated @ 125V DC (1P) dan @ 250V DC (2P in series).



Ezc100, 3P



Ezc100, 4P

EasyPact	Ir (A)	3P	Harga (Rp) (Sebelum PPN)	SS	4P	Harga (Rp) (Sebelum PPN)	SS
EasyPact Ezc100B (7.5 kA @415V AC)							
Ezc100B	15	Ezc100B3015	908.000	1 - MTS			
Ezc100B	20	Ezc100B3020	908.000	1 - MTS			
Ezc100B	25	Ezc100B3025	908.000	1 - MTS			
Ezc100B	30	Ezc100B3030	908.000	1 - MTS			
Ezc100B	40	Ezc100B3040	908.000	1 - MTS			
Ezc100B	50	Ezc100B3050	908.000	1 - MTS			
Ezc100B	60	Ezc100B3060	962.000	1 - MTS			
EasyPact Ezc100F (10 kA @415V AC)							
Ezc100F	15	Ezc100F3015	970.000	1 - MTS			
Ezc100F	20	Ezc100F3020	970.000	1 - MTS			
Ezc100F	25	Ezc100F3025	970.000	1 - MTS			
Ezc100F	30	Ezc100F3030	970.000	1 - MTS			
Ezc100F	40	Ezc100F3040	970.000	1 - MTS			
Ezc100F	50	Ezc100F3050	970.000	1 - MTS			
Ezc100F	60	Ezc100F3060	1.041.000	1 - MTS			
Ezc100F	75	Ezc100F3075	1.041.000	1 - MTS			
Ezc100F	80	Ezc100F3080	1.041.000	1 - MTS			
Ezc100F	100	Ezc100F3100	1.041.000	1 - MTS			
EasyPact Ezc100N (18 kA @380V AC / 15 kA @415V AC / 5 kA @125V DC; 250V DC)							
Ezc100N	15	Ezc100N3015	1.219.000	1 - MTS			
Ezc100N	20	Ezc100N3020	1.219.000	1 - MTS	Ezc100N4020	1.968.000	2 - MTO
Ezc100N	25	Ezc100N3025	1.219.000	1 - MTS	Ezc100N4025	1.968.000	2 - MTO
Ezc100N	30	Ezc100N3030	1.219.000	1 - MTS	Ezc100N4030	1.968.000	2 - MTO
Ezc100N	40	Ezc100N3040	1.219.000	1 - MTS	Ezc100N4040	1.968.000	2 - MTO
Ezc100N	50	Ezc100N3050	1.219.000	1 - MTS	Ezc100N4050	1.968.000	2 - MTO
Ezc100N	60	Ezc100N3060	1.331.000	1 - MTS	Ezc100N4060	2.148.000	2 - MTO
Ezc100N	75	Ezc100N3075	1.331.000	1 - MTS	Ezc100N4075	2.148.000	2 - MTO
Ezc100N	80	Ezc100N3080	1.331.000	1 - MTS	Ezc100N4080	2.148.000	2 - MTO
Ezc100N	100	Ezc100N3100	1.331.000	1 - MTS	Ezc100N4100	2.148.000	2 - MTO
EasyPact Ezc100H (30 kA @415V AC / 10 kA @125V DC; 250V DC)							
Ezc100H	15	Ezc100H3015	1.419.000	1 - MTS			
Ezc100H	20	Ezc100H3020	1.419.000	1 - MTS	Ezc100H4020	2.082.000	2 - MTO
Ezc100H	25	Ezc100H3025	1.419.000	1 - MTS	Ezc100H4025	2.082.000	2 - MTO
Ezc100H	30	Ezc100H3030	1.419.000	2 - MTO	Ezc100H4030	2.082.000	2 - MTO
Ezc100H	35	Ezc100H3035	1.419.000	1 - MTS			
Ezc100H	40	Ezc100H3040	1.419.000	1 - MTS	Ezc100H4040	2.082.000	2 - MTO
Ezc100H	50	Ezc100H3050	1.419.000	1 - MTS	Ezc100H4050	2.082.000	2 - MTO
Ezc100H	60	Ezc100H3060	1.507.000	1 - MTS	Ezc100H4060	2.307.000	2 - MTO
Ezc100H	75	Ezc100H3075	1.507.000	2 - MTO	Ezc100H4075	2.307.000	2 - MTO
Ezc100H	80	Ezc100H3080	1.507.000	1 - MTS	Ezc100H4080	2.307.000	2 - MTO
Ezc100H	100	Ezc100H3100	1.507.000	2 - MTO	Ezc100H4100	2.307.000	2 - MTO



Scan untuk Data Sheet



EZC250, 3P



EZC250, 4P

EasyPact™ EZC

Moulded Case Circuit Breaker 250A 2P/3P/4P

■ EasyPact EZC250 F/N/H

- Aplikasi untuk instalasi listrik dengan kapasitas pemutusan rendah.
- Kapasitas Pemutusan : 18 kA s/d 36 kA pada 380/415 VAC .
- Thermal magnetic trip unit, tidak dapat disetel (*non adjustable*).
- Fixed type, front connection,
- Satu ukuran (*frame size*) untuk semua rating.
- Memenuhi standar IEC 60947-2.
- Rated @ 125V DC (1P) dan @ 250V DC (2P)

EasyPact	Ir (A)	2P	Harga (Rp) (Sebelum PPN)	SS	3P	Harga (Rp) (Sebelum PPN)	SS
EasyPact EZC250F (18 kA @415V AC / 5 kA @125V DC; 250V DC)							
EZC250F	100				EZC250F3100	2.032.000	1 - MTS
EZC250F	125				EZC250F3125	2.081.000	1 - MTS
EZC250F	160				EZC250F3160	2.164.000	1 - MTS
EZC250F	200				EZC250F3200	2.318.000	1 - MTS
EZC250F	225				EZC250F3225	2.318.000	1 - MTS
EZC250F	250				EZC250F3250	2.318.000	1 - MTS
EasyPact EZC250N (25 kA @415V AC / 10 kA @125V DC; 250V DC)							
EZC250N	100				EZC250N3100	2.165.000	1 - MTS
EZC250N	125				EZC250N3125	2.268.000	1 - MTS
EZC250N	160				EZC250N3160	2.365.000	1 - MTS
EZC250N	200				EZC250N3200	2.894.000	1 - MTS
EZC250N	225				EZC250N3225	2.894.000	2 - MTO
EZC250N	250				EZC250N3250	2.894.000	1 - MTS
EasyPact EZC250H (36 kA @415V AC / 30 kA @125V DC; 250V DC)							
EZC250H	100	EZC250H2100	2.387.000	2 - MTO	EZC250H3100	2.514.000	2 - MTO
EZC250H	125	EZC250H2125	2.464.000	2 - MTO	EZC250H3125	2.591.000	1 - MTS
EZC250H	160	EZC250H2160	2.670.000	2 - MTO	EZC250H3160	2.812.000	1 - MTS
EZC250H	200	EZC250H2200	2.859.000	2 - MTO	EZC250H3200	3.065.000	1 - MTS
EZC250H	225	EZC250H2225	2.859.000	2 - MTO	EZC250H3225	3.065.000	2 - MTO
EZC250H	250	EZC250H2250	2.859.000	2 - MTO	EZC250H3250	3.065.000	1 - MTS

EasyPact	Ir (A)	4P	Harga (Rp) (Sebelum PPN)	SS
EasyPact EZC250N (25 kA @415V AC / 10 kA @125V DC; 250V DC)				
EZC250N	100	EZC250N4100	2.978.000	2 - MTO
EZC250N	125	EZC250N4125	3.112.000	2 - MTO
EZC250N	160	EZC250N4160	3.231.000	2 - MTO
EZC250N	200	EZC250N4200	3.590.000	2 - MTO
EZC250N	225			
EZC250N	250	EZC250N4250	3.590.000	2 - MTO
EasyPact EZC250H (36 kA @415V AC / 30 kA @125V DC; 250V DC)				
EZC250H	100	EZC250H4100	3.499.000	2 - MTO
EZC250H	125	EZC250H4125	3.499.000	2 - MTO
EZC250H	160	EZC250H4160	3.884.000	2 - MTO
EZC250H	200	EZC250H4200	4.174.000	2 - MTO
EZC250H	250	EZC250H4250	4.251.000	2 - MTO



Scan untuk Data Sheet



EZCV250, 3P



EZCV250, 4P



EZC400-630

EasyPact™ EZC

Moulded Case Circuit Breaker 250A Dengan Proteksi Arus Bocor Moulded Case Circuit Breaker 400-630A

■ EasyPact EZCV250 N/H

- Integrated dengan proteksi arus bocor (Earth Leakage Protection).
- Aplikasi untuk instalasi listrik dengan kapasitas pemutusan rendah.
- Kapasitas Pemutusan : 25 kA s/d 36 kA pada 380/415 VAC.
- Thermal magnetic trip unit, tidak dapat disetel (*non adjustable*).
- Integrated dengan proteksi arus bocor (*Earth Leakage Protection*).
- Fixed type, front connection.
- Satu ukuran (*frame size*) dengan EZC250.
- Memenuhi standar IEC 60947-2.

EasyPact	Ir (A)	3P	Harga (Rp) (Sebelum PPN)	SS	4P	Harga (Rp) (Sebelum PPN)	SS
EasyPact EZCV250N (25 kA @415V AC)							
EZCV250N	100	EZCV250N3100	5.723.000	2 - MTO			
EZCV250N	125	EZCV250N3125	6.524.000	2 - MTO	EZCV250N4125	9.133.000	2 - MTO
EZCV250N	160				EZCV250N4160	9.956.000	2 - MTO
EZCV250N	200				EZCV250N4200	10.528.000	2 - MTO
EZCV250N	250	EZCV250N3250	7.523.000	2 - MTO			
EasyPact EZCV250H (36 kA @415V AC)							
EZCV250H	100				EZCV250H4100	8.338.000	2 - MTO
EZCV250H	125				EZCV250H4125	9.377.000	2 - MTO
EZCV250H	160				EZCV250H4160	10.224.000	2 - MTO
EZCV250H	200				EZCV250H4200	11.034.000	2 - MTO
EZCV250H	225						
EZCV250H	250	EZCV250H3250	8.362.000	2 - MTO	EZCV250H4250	11.034.000	2 - MTO

■ EasyPact EZC400 N/H

- Aplikasi untuk instalasi listrik dengan kapasitas pemutusan
- Kapasitas Pemutusan : 36 kA s/d 50 kA pada 380/415 VAC .
- Thermal magnetic trip unit, tidak dapat disetel (*non adjustable*).
- Fixed type, front connection.
- Satu ukuran (*frame size*) untuk semua rating.
- Memenuhi standar IEC 60947-2.

⚠️ TM600D akan diskontinyu dan digantikan dengan TM630D

EasyPact	Ir (A)	3P	Harga (Rp) (Sebelum PPN)	SS	4P	Harga (Rp) (Sebelum PPN)	SS
EasyPact EZC400N (36 kA @415V AC)							
EZC400N	320	EZC400N3320N	5.012.000	1 - MTS	EZC400N4320N	7.422.000	2 - MTO
EZC400N	350	EZC400N3350N	5.210.000	1 - MTS	EZC400N4350N	7.719.000	2 - MTO
EZC400N	400	EZC400N3400N	5.420.000	1 - MTS	EZC400N4400N	8.259.000	2 - MTO
EasyPact EZC630N (36 kA @415V AC)							
EZC630N	500	EZC630N3500N	8.827.000	2 - MTO	EZC630N4500N	10.793.000	2 - MTO
EZC630N	600	EZC630N3600N	9.713.000	1 - MTS	EZC630N4600N	13.595.000	2 - MTO
EZC630N	630	EZC630N3630N	10.187.000	2 - MTO	EZC630N4630N	14.000.000	2 - MTO
EasyPact EZC400H (50 kA @415V AC)							
EZC400H	320	EZC400H3320N	5.963.000	2 - MTO	EZC400H4320N	8.592.000	2 - MTO
EZC400H	350	EZC400H3350N	6.087.000	2 - MTO	EZC400H4350N	8.933.000	2 - MTO
EZC400H	400	EZC400H3400N	6.329.000	2 - MTO	EZC400H4400N	9.560.000	2 - MTO
EasyPact EZC630H (50 kA @415V AC)							
EZC630H	500	EZC630H3500N	9.768.000	2 - MTO	EZC630H4500N	13.424.000	2 - MTO
EZC630H	600	EZC630H3600N	11.254.000	2 - MTO	EZC630H4600N	15.466.000	2 - MTO
EZC630H	630	EZC630H3630N	12.000.000	2 - MTO	EZC630H4630N	15.600.000	2 - MTO

Moulded Case Circuit Breaker (MCCB)

PPCCB

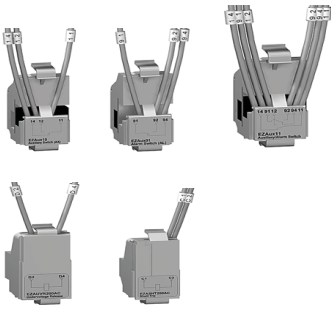

Kontak Bantu EasyPact 100

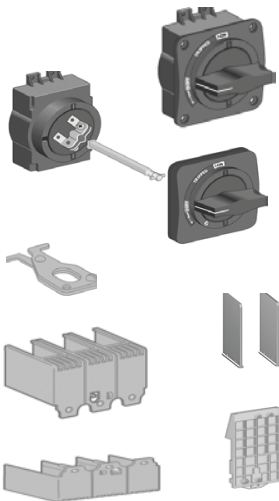

Aksesori EasyPact 100

EasyPact™ Ezc

Aksesori EasyPact™ Ezc 100A

Kontak Bantu & Aksesori

■ Kontak Bantu

Kontak Bantu	Teg kontrol (V)	Referensi	Harga (Rp) (Sebelum PPN)	SS
Auxiliary Switch (AX)		EZAUX10	391.000	1 - MTS
Alarm Switch (AL)		EZAUX01	480.000	2 - MTO
Auxiliary Switch / Alarm Switch (AX/AL)		EZAUX11	781.000	1 - MTS
Shunt Trip (SHT)	100-130 VAC	EZASHT100AC	782.000	2 - MTO
	200-277 VAC	EZASHT200AC	782.000	1 - MTS
	380-480 VAC	EZASHT380AC	949.000	2 - MTO
	24 VDC	EZASHT024DC	1.086.000	2 - MTO
Undervoltage Release (UVR)	200-240 VAC	EZAUVR200AC	2.217.000	2 - MTO

■ Aksesori

Aksesori	Qty	Referensi	Harga (Rp) (Sebelum PPN)	SS
Rotary handle		EZAROTDS	869.000	2 - MTO
		EZAROTE	1.261.000	2 - MTO
Toggle padlocking device		EZALOCK	141.000	2 - MTO
Terminal shield (hanya untuk 3P)	2	EZATSHD3P	165.000	2 - MTO
Phase barrier	2	EZAFASB2	106.000	2 - MTO
Plug-in		EZAPLUG3L	1.431.000	2 - MTO
		EZAPLUG3H	1.431.000	2 - MTO

Moulded Case Circuit Breaker (MCCB)

PPCCB



Kontak Bantu EasyPact 250



Aksesori EasyPact 250

EasyPact™ EZC

Aksesori EasyPact EZC250 dan EasyPact EZCV250

Kontak Bantu & Aksesori

■ Kontak Bantu

Kontak Bantu	Referensi	Harga (Rp) (Sebelum PPN)	SS
Auxiliary Switch (AX)	EZEAX	482.000	1 - MTS
Alarm Switch (AL)	EZEAL	585.000	2 - MTO
Auxiliary Switch / Alarm Switch (AX/AL)	EZEAXAL	955.000	1 - MTS

Kontak Bantu	Teg Kontrol (V)	Referensi	Harga (Rp) (Sebelum PPN)	SS
Shunt Trip	200-240VAC	EZESHT200AC	1.044.000	1 - MTS
Under Voltage Release (UVR)	200-240 VAC	EZEUVR200AC	5.909.000	1 - MTS
Under Voltage Release (UVR)	200-240 VAC	EZEUVRN200AC ⁽¹⁾	4.845.000	2 - MTO

(1) hanya untuk EZC250 4P dan EZCV250 3/4P

■ Aksesori

Aksesori	Qty	Referensi	Harga (Rp) (Sebelum PPN)	SS	
Rotary handle		Direct rotary handle	EZEROTDS	896.000	2 - MTO
		Extended rotary handle	EZEROTE	1.306.000	2 - MTO
Toggle padlocking device		untuk EZC250 3P	EZELOCK	143.000	2 - MTO
		untuk EZC250 4P dan EZCV250 3/4P	EZELOCKN	143.000	2 - MTO
Terminal shield	2	EZETSHD3P	345.000	2 - MTO	
	2	EZETSHD3PN	319.000	2 - MTO	
	2	EZETSHD4PN	442.000	2 - MTO	
	3	EZESPDR3P	319.000	2 - MTO	
Spreader	4	EZESPDR4P	821.000	2 - MTO	
	3	EZETEX	438.000	2 - MTO	
Phase barrier	2	EZEFASB2	108.000	2 - MTO	
Plug-in		Kit, plug-in base 3P 100 A - 250 A 60mm breaker	EZEPLUG3L	3.656.000	2 - MTO



Auxiliary Contact



Voltage Release

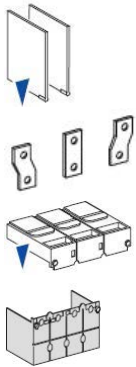

Aksesori Koneksi

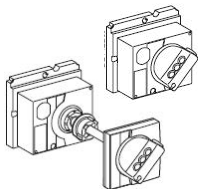

Rotary Handle

EasyPact™ Ezc

Aksesori EasyPact™ Ezc 400-630

Kontak Bantu & Aksesori

■ Kontak Bantu

Memberikan petunjuk mengenai penyebab terputusnya pemutus tenaga.

- **OF** : Menunjukkan status circuit breaker, tertutup (ON) atau terbuka (OFF).
- **SD** : Menunjukkan circuit breaker trip karena beban lebih, hubung singkat, gangguan tanah, bekerjanya voltage release, operasi tombol push-to trip
- **SDE** : Menunjukkan circuit breaker trip karena beban lebih, hubung singkat, gangguan tanah (Vigi, Micrologic 6).

Kontak Bantu	Referensi	Harga (Rp) (Sebelum PPN)	SS
OF/SD/SDE	29450	570.000	1 - MTS
OF/SD/SDE Low Level	29452	632.000	2 - MTO
SDE adaptor mandatory for trip unit TM	LV540050	310.000	1 - MTS

■ Voltage Release

- **MN** : Under voltage release, mentriapkan circuit breaker saat tegangan kontrol jatuh di bawah batas yang ditentukan (antara 0,35 - 0,7 Un).
- **MX** : Shunt trip, mentriapkan circuit breaker saat tegangan kontrol mencapai 0,7 Un.

Tegangan Kontrol V	MX	Harga (Rp) (Sebelum PPN)	SS	MN	Harga (Rp) (Sebelum PPN)	SS	
AC 50/60 Hz	110/130	LV429386	1.428.000	2 - MTO	LV429406	1.904.000	2 - MTO
	200/240	LV429387	1.428.000	1 - MTS	LV429407	1.904.000	1 - MTS
	380/415 (50 Hz)	LV429388	1.428.000	2 - MTO	LV429408	1.904.000	2 - MTO
DC	12	LV429382	1.428.000	2 - MTO	LV429402	1.904.000	2 - MTO
	24	LV429390	1.428.000	2 - MTO	LV429410	1.904.000	2 - MTO
	30	LV429391	1.428.000	2 - MTO	LV429411	2.745.000	2 - MTO
	48	LV429392	1.428.000	2 - MTO	LV429412	1.904.000	2 - MTO
	125	LV429393	1.428.000	2 - MTO	LV429413	1.904.000	2 - MTO
	250	LV429394	1.428.000	2 - MTO	LV429414	1.904.000	2 - MTO
	MN 220/240 VAC dengan tunda waktu (untuk MN 250 V DC LV429414)				LV429427	4.331.000	2 - MTO

■ Aksesori Koneksi

Aksesori Koneksi	Qty	Ezc 400	Harga (Rp) (Sebelum PPN)	SS	
Phase barrier	6	LV432570	372.000	2 - MTO	
Spreader	52.5 mm	3P	LV432490	953.000	1 - MTS
		4P	LV432491	1.308.000	2 - MTO
	70 mm	3P	LV432492	1.459.000	2 - MTO
		4P	LV432493	1.910.000	2 - MTO
Terminal shield	Pendek	3P	1 psg LV432591	467.000	2 - MTO
		4P	1 psg LV432592	731.000	2 - MTO
	Panjang	3P	1 psg LV432593	556.000	2 - MTO
		4P	1 psg LV432594	731.000	2 - MTO

■ Rotary Handle

- Tetap menjaga indikasi 3 posisi : O (OFF), I (ON) dan trip.
- Fungsi isolasi masih tetap terjaga.
- Circuit breaker dapat dikunci pada posisi OFF dengan gembok.

Rotary Handle	Ezc 400	Harga (Rp) (Sebelum PPN)	SS	
Direct rotary handle	Standar, handel hitam	LV432597	1.281.000	2 - MTO
Extended rotary handle	Standar, handel hitam	LV432598	1.892.000	2 - MTO



Scan untuk Data Sheet

ComPacT NSXm

ComPacT NSXm Baru

Moulded Case Circuit Breaker 100A s/d 160A

ComPacT NSXm Baru!

The Efficiency that clicks

Thermal magnetic trip unit hingga 160A dan 70kA @ 415V

Dengan Berbagai Keunggulan

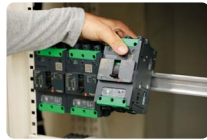

Instalasi Fleksibel : Pemasangan DIN rail atau mounting plate



Satu kali klik untuk pemasangan Aksesori dan kontak bantu



Breakaway bit pembatas torsi dengan terminal Everlink



Berbagai mekanisme Rotary handle



Terintegrasi dengan proteksi arus bocor (Earth Leakage Protection)



Tehnologi Everlink yang dipatenkan

■ Penamaan Referensi Baru

Misalnya **LV426107** akan menjadi **C11E3TM100L**
(ComPacT Breaker NSXm100 16kA AC 3P3D 100A TMD Everlink)

Tipe	Rating Frame	Breaking Capacity	Jumlah Kutub	Trip Unit	Rating Trip Unit	Imbuhan Akhir
C = NSX C = NSXm	11 = 100m 12 = 160m 10 = 100 16 = 160 25 = 250 40 = 400 63 = 630	E = 16kA B = 25kA F = 36kA N = 50kA H = 70kA S = 100kA L = 150kA ...	1 = 1P 2 = 2P 3 = 3P3D 4 = 4P4D 5 = 3P2D 6 = 4P3D	TM = TMD MA = MA MG = TMG 1M = 1.3 M 2D = 2.2 2D = 2.3 4V = 4.1 4V = 4.2 ...	016 = 16 020 = 20 025 = 25 030 = 30 040 = 40 050 = 50 063 = 63 080 = 80 100 = 100 125 = 125 ...	L = EverLink B = Busbar F = Fixed D = DC S = Switch DP = DC PV



Scan untuk Data Sheet

ComPacT NSXm100-160 E/B/F dengan TMD

Dirancang dengan teknologi pemutusan Roto-Active, memberikan kehandalan dalam "Current Limiting Capacity".

- Arus Nominal (In) : 16A - 160A.
- Kapasitas Pemutusan : 16 s/d 70 kA pada 380/415 VAC.
- Ics = 100% Icu.⁽¹⁾
- Trip unit : Thermal Magnetic Untuk proteksi beban distribusi.
- Koneksi "Everlink" yang dipatenkan untuk mencegah koneksi kawan dan terminal kendur/longgar.
- Mudah dipasang pada rel DIN atau plate dan pintu yang sama cut-out sebagai Acti9 MCB.
- Kapasitas Pemutusan Diskriminasi penuh hingga downstream breaker (diagram tersedia).
- Jenis Aksesoris dan kontrol tegangan terlihat jelas.
- Fixed type, front connection.
- Memenuhi standar IEC 60947-2.

Trip Unit	Everlink TM connectors				Compression lug/busbar connectors							
	3P	Harga (Rp) (Sebelum PPN)	SS	4P	Harga (Rp) (Sebelum PPN)	SS	3P	Harga (Rp) (Sebelum PPN)	SS	4P	Harga (Rp) (Sebelum PPN)	SS
ComPacT NSXm dengan E (16 kA)												
TM16D	C11E3TM016L	1.699.000	2 - MTO	C11E6TM016L	2.291.000	2 - MTO	C11E3TM016B	1.699.000	2 - MTO	C11E6TM016B	2.291.000	2 - MTO
TM25D	C11E3TM025L	1.699.000		C11E6TM025L	2.291.000		C11E3TM025B	1.699.000		C11E6TM025B	2.291.000	
TM32D	C11E3TM032L	1.699.000		C11E6TM032L	2.291.000		C11E3TM032B	1.699.000		C11E6TM032B	2.291.000	
TM40D	C11E3TM040L	1.733.000		C11E6TM040L	2.335.000		C11E3TM040B	1.733.000		C11E6TM040B	2.335.000	
TM50D	C11E3TM050L	1.733.000		C11E6TM050L	2.335.000		C11E3TM050B	1.733.000		C11E6TM050B	2.335.000	
TM63D	C11E3TM063L	1.838.000		C11E6TM063L	2.407.000		C11E3TM063B	1.838.000		C11E6TM063B	2.407.000	
TM80D	C11E3TM080L	1.874.000		C11E6TM080L	2.407.000		C11E3TM080B	1.874.000		C11E6TM080B	2.407.000	
TM100D	C11E3TM100L	1.874.000		C11E6TM100L	2.407.000		C11E3TM100B	1.874.000		C11E6TM100B	2.407.000	
TM125D	C12E3TM125L	2.634.000		C12E6TM125L	3.390.000		C12E3TM125B	2.634.000		C12E6TM125B	3.390.000	
TM160D	C12E3TM160L	3.340.000		C12E6TM160L	3.987.000		C12E3TM160B	3.340.000		C12E6TM160B	3.986.000	
ComPacT NSXm dengan B (25 kA)												
TM16D	C11B3TM016L	1.834.000	2 - MTO	C11B6TM016L	2.463.000	2 - MTO	C11B3TM016B	1.825.000	2 - MTO	C11B6TM016B	2.463.000	2 - MTO
TM25D	C11B3TM025L	1.825.000		C11B6TM025L	2.463.000		C11B3TM025B	1.825.000		C11B6TM025B	2.463.000	
TM32D	C11B3TM032L	1.825.000		C11B6TM032L	2.463.000		C11B3TM032B	1.825.000		C11B6TM032B	2.463.000	
TM40D	C11B3TM040L	1.834.000		C11B6TM040L	2.474.000		C11B3TM040B	1.825.000		C11B6TM040B	2.474.000	
TM50D	C11B3TM050L	1.834.000		C11B6TM050L	2.474.000		C11B3TM050B	1.825.000		C11B6TM050B	2.474.000	
TM63D	C11B3TM063L	1.945.000		C11B6TM063L	2.548.000		C11B3TM063B	1.945.000		C11B6TM063B	2.548.000	
TM80D	C11B3TM080L	1.984.000		C11B6TM080L	2.548.000		C11B3TM080B	1.984.000		C11B6TM080B	2.548.000	
TM100D	C11B3TM100L	1.984.000		C11B6TM100L	2.548.000		C11B3TM100B	1.984.000		C11B6TM100B	2.548.000	
TM125D	C12B3TM125L	2.787.000		C12B6TM125L	3.591.000		C12B3TM125B	2.790.000		C12B6TM125B	3.588.000	
TM160D	C12B3TM160L	3.534.000		C12B6TM160L	4.220.000		C12B3TM160B	3.534.000		C12B6TM160B	4.220.000	
ComPacT NSXm dengan F (36 kA)												
TM16D	C11F3TM016L	1.937.000	2 - MTO	C11F6TM016L	2.611.000	2 - MTO	C11F3TM016B	1.937.000	2 - MTO	C11F6TM016B	2.610.000	2 - MTO
TM25D	C11F3TM025L	1.937.000		C11F6TM025L	2.611.000		C11F3TM025B	1.937.000		C11F6TM025B	2.610.000	
TM32D	C11F3TM032L	1.937.000		C11F6TM032L	2.611.000		C11F3TM032B	1.937.000		C11F6TM032B	2.610.000	
TM40D	C11F3TM040L	1.937.000		C11F6TM040L	2.611.000		C11F3TM040B	1.937.000		C11F6TM040B	2.610.000	
TM50D	C11F3TM050L	1.937.000		C11F6TM050L	2.611.000		C11F3TM050B	1.937.000		C11F6TM050B	2.610.000	
TM63D	C11F3TM063L	2.094.000		C11F6TM063L	2.689.000		C11F3TM063B	2.094.000		C11F6TM063B	2.688.000	
TM80D	C11F3TM080L	2.094.000		C11F6TM080L	2.689.000		C11F3TM080B	2.094.000		C11F6TM080B	2.688.000	
TM100D	C11F3TM100L	2.094.000		C11F6TM100L	2.689.000		C11F3TM100B	2.094.000		C11F6TM100B	2.688.000	
TM125D	C12F3TM125L	2.942.000		C12F6TM125L	3.787.000		C12F3TM125B	2.942.000		C12F6TM125B	3.787.000	
TM160D	C12F3TM160L	3.731.000		C12F6TM160L	4.453.000		C12F3TM160B	3.732.000		C12F6TM160B	4.453.000	

(1) Ics = Service Breaking Capacity, Icu = Ultimate Breaking Capacity.



ComPacT NSXm 3P ComPacT NSXm 3P ComPacT NSXm 4P



Scan untuk Data Sheet

ComPacT NSXm (Proteksi Distribusi)

Moulded Case Circuit Breaker 100A s/d 160A

■ ComPacT NSXm100-160 N/H dengan TMD

Dirancang dengan teknologi pemutusan Roto-Active, memberikan kehandalan dalam "Current Limiting Capacity".

- Arus Nominal (In) : 16A- 160A
- Kapasitas Pemutusan : 16 s/d 70 kA pada 380/415 VAC.
- Ics = 100% Icu.⁽¹⁾
- Trip unit : Thermal Magnetic Untuk proteksi beban distribusi.
- Koneksi "Everlink" yang dipatenkan menghindari kendur dan memberikan kontrol kawat terminal
- Mudah dipasang pada rel DIN atau plate dan pintu yang sama cut-out sebagai Acti9 MCB
- Full Discriminated sampai downstream breaker Kapasitas Pemutusan (grafik tersedia)
- Jenis Aksesori dan kontrol tegangan terlihat jelas
- Fixed type, front connection.
- Memenuhi standar IEC 60947-2.

Trip Unit	Everlink™ connectors					Compression lug/busbar connectors						
	3P	Harga (Rp) (Sebelum PPN)	SS	4P	Harga (Rp) (Sebelum PPN)	SS	3P	Harga (Rp) (Sebelum PPN)	SS	4P	Harga (Rp) (Sebelum PPN)	SS
ComPacT NSXm dengan N (50 kA)												
TM16D	C11N3TM016L	2.280.000	2 - MTO	C11N6TM016L	3.073.000	2 - MTO	C11N3TM016B	2.261.000	2 - MTO	C11N6TM016B	3.054.000	2 - MTO
TM25D	C11N3TM025L	2.280.000		C11N6TM025L	3.073.000		C11N3TM025B	2.261.000		C11N6TM025B	3.054.000	
TM32D	C11N3TM032L	2.280.000		C11N6TM032L	3.073.000		C11N3TM032B	2.261.000		C11N6TM032B	3.054.000	
TM40D	C11N3TM040L	2.280.000		C11N6TM040L	3.073.000		C11N3TM040B	2.302.000		C11N6TM040B	3.104.000	
TM50D	C11N3TM050L	2.280.000		C11N6TM050L	3.073.000		C11N3TM050B	2.302.000		C11N6TM050B	3.104.000	
TM63D	C11N3TM063L	2.349.000		C11N6TM063L	3.167.000		C11N3TM063B	2.372.000		C11N6TM063B	3.197.000	
TM80D	C11N3TM080L	2.349.000		C11N6TM080L	3.167.000		C11N3TM080B	2.372.000		C11N6TM080B	3.197.000	
TM100D	C11N3TM100L	2.372.000		C11N6TM100L	3.167.000		C11N3TM100B	2.372.000		C11N6TM100B	3.197.000	
TM125D	C12N3TM125L	3.194.000		C12N6TM125L	4.117.000		C12N3TM125B	3.194.000		C12N6TM125B	4.157.000	
TM160D	C12N3TM160L	3.815.000		C12N6TM160L	4.919.000		C12N3TM160B	3.815.000		C12N6TM160B	4.965.000	
ComPacT NSXm dengan H (70 kA)												
TM16D	C11H3TM016L	2.699.000	2 - MTO	C11H6TM016L	3.603.000	2 - MTO	C11H3TM016B	2.674.000	2 - MTO	C11H6TM016B	3.603.000	2 - MTO
TM25D	C11H3TM025L	2.699.000		C11H6TM025L	3.603.000		C11H3TM025B	2.674.000		C11H6TM025B	3.603.000	
TM32D	C11H3TM032L	2.699.000		C11H6TM032L	3.637.000		C11H3TM032B	2.674.000		C11H6TM032B	3.603.000	
TM40D	C11H3TM040L	2.674.000		C11H6TM040L	3.637.000		C11H3TM040B	2.674.000		C11H6TM040B	3.603.000	
TM50D	C11H3TM050L	2.699.000		C11H6TM050L	3.603.000		C11H3TM050B	2.674.000		C11H6TM050B	3.603.000	
TM63D	C11H3TM063L	2.751.000		C11H6TM063L	3.710.000		C11H3TM063B	2.751.000		C11H6TM063B	3.710.000	
TM80D	C11H3TM080L	2.778.000		C11H6TM080L	3.747.000		C11H3TM080B	2.807.000		C11H6TM080B	3.784.000	
TM100D	C11H3TM100L	2.807.000		C11H6TM100L	3.784.000		C11H3TM100B	2.807.000		C11H6TM100B	3.784.000	
TM125D	C12H3TM125L	3.688.000		C12H6TM125L	4.775.000		C12H3TM125B	3.688.000		C12H6TM125B	4.775.000	
TM160D	C12H3TM160L	4.479.000		C12H6TM160L	5.703.000		C12H3TM160B	4.479.000		C12H6TM160B	5.703.000	

(1) Ics = Service Breaking Capacity, Icu = Ultimate Breaking Capacity



ComPacT NSXm 3P



ComPacT NSXm 4P



Scan untuk Data Sheet

ComPacT NSXm (Proteksi Distribusi - Arus Bocor) Moulded Case Circuit Breaker 100A s/d 160A dengan ELCB

■ **ComPacT NSXm 100-160 E/B/F/N/H dengan Perlindungan Arus Bocor**
Dirancang dengan teknologi pemutusan Roto-Active, memberikan kehandalan dalam "Current Limiting Capacity".

- Arus Nominal (In) : 16A - 160A
- Kapasitas Pemutusan : 16 s/d 70 kA pada 380/415 VAC.
- Ics = 100% Icu.⁽¹⁾
- Trip unit : Electronic trip unit dengan proteksi overload, short-circuit dan arus bocor untuk beban distribusi
- Koneksi "Everlink" yang dipatenkan menghindari kendur dan memberikan kontrol kawat terminal
- Mudah dipasang pada rel DIN atau plate dan pintu yang sama cut-out sebagai Acti9 MCB
- Full Discriminated sampai downstream breaker Kapasitas Pemutusan (grafik tersedia)
- Jenis Aksesoris dan kontrol tegangan terlihat jelas
- Fixed type, front connection.
- Memenuhi standar IEC 60947-2.

Trip Unit	Everlink™ connectors						Compression lug/busbar connectors					
	3P	Harga (Rp) (Sebelum PPN)	SS	4P	Harga (Rp) (Sebelum PPN)	SS	3P	Harga (Rp) (Sebelum PPN)	SS	4P	Harga (Rp) (Sebelum PPN)	SS
ComPacT NSXm dengan E (16 kA) termasuk ELCB Vigi												
Vigi TM25D	C11E34V025L	6.377.000	2 - MTO	C11E44V025L	8.279.000	2 - MTO	C11E34V025B	6.377.000	2 - MTO	C11E44V025B	8.279.000	2 - MTO
Vigi TM50D	C11E34V050L	6.377.000		C11E44V050L	7.666.000		C11E34V050B	6.377.000		C11E44V050B	8.279.000	
Vigi TM100D	C11E34V100L	6.519.000		C11E44V100L	7.732.000		C11E34V100B	6.519.000		C11E44V100B	8.351.000	
Vigi TM160D	C12E34V160L	8.015.000		C12E44V160L	9.963.000		C12E34V160B	8.015.000		C12E44V160B	9.963.000	
ComPacT NSXm dengan B (25 kA) termasuk ELCB Vigi												
Vigi TM25D	C11B34V025L	6.730.000	2 - MTO	C11B44V025L	8.897.000	2 - MTO	C11B34V025B	6.730.000	2 - MTO	C11B44V025B	8.740.000	2 - MTO
Vigi TM50D	C11B34V050L	6.730.000		C11B44V050L	8.969.000		C11B34V050B	6.730.000		C11B44V050B	8.740.000	
Vigi TM100D	C11B34V100L	6.881.000		C11B44V100L	9.109.000		C11B34V100B	6.881.000		C11B44V100B	8.817.000	
Vigi TM160D	C12B34V160L	8.460.000		C12B44V160L	11.020.000		C12B34V160B	8.460.000		C12B44V160B	7.497.000	
ComPacT NSXm dengan F (36 kA) termasuk ELCB Vigi												
Vigi TM25D	C11F34V025L	7.083.000	2 - MTO	C11F44V025L	9.198.000	2 - MTO	C11F34V025B	7.083.000	2 - MTO	C11F44V025B	9.198.000	2 - MTO
Vigi TM50D	C11F34V050L	7.083.000		C11F44V050L	9.198.000		C11F34V050B	7.083.000		C11F44V050B	9.198.000	
Vigi TM100D	C11F34V100L	7.243.000		C11F44V100L	9.278.000		C11F34V100B	7.243.000		C11F44V100B	9.278.000	
Vigi TM160D	C12F34V160L	8.905.000		C12F44V160L	11.069.000		C12F34V160B	8.905.000		C12F44V160B	11.069.000	
ComPacT NSXm dengan N (50 kA) termasuk ELCB Vigi												
Vigi TM25D	C11N34V025L	7.455.000	2 - MTO	C11N44V025L	9.700.000	2 - MTO	C11N34V025B	7.455.000	2 - MTO	C11N44V025B	9.700.000	2 - MTO
Vigi TM50D	C11N34V050L	7.455.000		C11N44V050L	9.700.000		C11N34V050B	7.455.000		C11N44V050B	9.700.000	
Vigi TM100D	C11N34V100L	7.526.000		C11N44V100L	9.793.000		C11N34V100B	7.526.000		C11N44V100B	9.793.000	
Vigi TM160D	C12N34V160L	8.989.000		C12N44V160L	11.589.000		C12N34V160B	8.989.000		C12N44V160B	11.589.000	
ComPacT NSXm dengan N (50 kA) termasuk ELCB Vigi												
Vigi TM25D	C11H34V025L	7.884.000	2 - MTO	C11H44V025L	10.277.000	2 - MTO	C11H34V025B	7.884.000	2 - MTO	C11H44V025B	10.277.000	2 - MTO
Vigi TM50D	C11H34V050L	7.884.000		C11H44V050L	10.277.000		C11H34V050B	7.884.000		C11H44V050B	10.277.000	
Vigi TM100D	C11H34V100L	7.965.000		C11H44V100L	10.388.000		C11H34V100B	7.965.000		C11H44V100B	10.388.000	
Vigi TM160D	C12H34V160L	9.663.000		C12H44V160L	12.337.000		C12H34V160B	10.187.000		C12H44V160B	12.337.000	

(1) Ics = Service Breaking Capacity, Icu = Ultimate Breaking Capacity.



ComPacT NSXm
Micrologic 4.1

Moulded Case Circuit Breaker (MCCB)

PPCCB



Kontak Bantu



Voltage Release



Rotary Handle

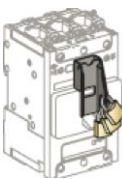

Locking

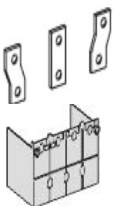

Aksesori Koneksi

ComPacT NSXm

Aksesori ComPacT NSXm

■ Kontak Bantu

Memberikan petunjuk mengenai penyebab terputusnya pemutus tenaga.

- **OF** : Menunjukkan status circuit breaker, tertutup (ON) atau terbuka (OFF).
- **SD** : Menunjukkan circuit breaker trip karena beban lebih, hubung singkat, gangguan tanah, bekerjanya voltage release, operasi tombol push-to trip

Tipe	Referensi NSXm 16-160	Harga (Rp) (Sebelum PPN)	SS
OF/SD	LV426950	509.000	2 - MTO

■ Voltage Release

- **MN** : Under voltage release, mentripping circuit breaker saat tegangan kontrol jatuh di bawah batas yang ditentukan (antara 0,35 - 0,7 Un).
- **MX** : Shunt trip, mentripping circuit breaker saat tegangan kontrol mencapai 0,7 Un.

Tegangan Kontrol (V)	MX	Harga (Rp) (Sebelum PPN)	SS	MN	Harga (Rp) (Sebelum PPN)	SS
24V 50/60 Hz	LV426841	1.325.000	2 - MTO	LV426801	1.765.000	2 - MTO
48V 50/60 Hz	LV426842	1.325.000	2 - MTO	LV426802	2.546.000	2 - MTO
110/130V 50/60 Hz	LV426843	1.325.000	2 - MTO	LV426803	1.765.000	2 - MTO
200/240V 50 Hz, 208-240V 60 Hz	LV426844	1.332.000	2 - MTO	LV426804	1.765.000	2 - MTO
277 (60Hz)	LV426844	1.332.000	2 - MTO	LV426805	2.546.000	2 - MTO
380/415 (50 Hz)	LV426846	1.325.000	2 - MTO	LV426806	1.765.000	2 - MTO
440/480 (60 Hz)	LV426846	1.325.000	2 - MTO	LV426807	2.546.000	2 - MTO
24V	LV426841	1.325.000	2 - MTO	LV426801	1.765.000	2 - MTO
48V	LV426842	1.325.000	2 - MTO	LV426802	2.546.000	2 - MTO
125V	LV426843	1.325.000	2 - MTO	LV426803	1.765.000	2 - MTO
250V	LV426844	1.332.000	2 - MTO	LV426815	1.765.000	2 - MTO
MN 220/240 VAC dengan tunda waktu (untuk MN 250 V DC LV426815)				LV429427	4.331.000	2 - MTO

■ Rotary Handle

- Tetap menjaga indikasi 3 posisi : O (OFF), I (ON) dan trip.
- Fungsi isolasi masih tetap terjaga.
- Circuit breaker dapat dikunci pada posisi OFF dengan gembok.

Rotary Handle		NSXm 16-250	Harga (Rp) (Sebelum PPN)	SS
Direct rotary handle	Standar, handel hitam	LV426930T	713.000	2 - MTO
Extended rotary handle	Standar, handel hitam	LV426932T	1.080.000	2 - MTO
	Open door shaft	LV426937	383.000	2 - MTO
Side rotary handle	Standar, handel hitam	LV426935T	1.132.000	2 - MTO

■ Locking

Locking	NSXm 16-160	Harga (Rp) (Sebelum PPN)	SS
Toggle locking device untuk 1-3 gembok (gembok tidak disupply)			
Removable device	29370	246.000	2 - MTO
Fixed device (OFF atau ON)	LV426905	530.000	2 - MTO

Catatan : Hanya bisa di pasang pada produk NSX

Tidak boleh diorder terpisah dan harus dirakit oleh PT Schneider Indonesia atau pihak yang mendapat izin resmi.

■ Aksesori Koneksi

Aksesori Koneksi		NSXm 16-160	Harga (Rp) (Sebelum PPN)	SS	
Spreader 27-35 mm	3P	LV426940	335.000	2 - MTO	
	4P	LV426941	407.000	2 - MTO	
Terminal shield	Panjang 3P	1 psg	LV426912	214.000	2 - MTO
	Panjang 4P	1 psg	LV426913	214.000	2 - MTO
Inter phase barrier	6	LV426920	211.000	2 - MTO	



Scan untuk Data Sheet



ComPacT NSX Baru

Direct Access to Energy Efficiency

ComPacT NSX Baru

- 2 ukuran rangka: 16-250A & 400-630A dengan 3P & 4P
- Kapasitas pemutus (Icu): 36kA ke 200kA dengan $I_{cs} = 100\% \times I_{cu}$
- Mekanisme rotor rem ganda
- Tegangan operasional 440VAC
- Fixed, Plug-in, Drawout tipe
- Full Discriminated menawarkan kontinuitas lengkap layanan & Keandalan
- DC circuit breaker, 400Hz, 1P-2P, PV version
- Energi metering terpasang
- Smart Plug dan jaringan komunikasi Putar

Micrologic Electronic trip units

Protection	Frame	Measurement	Applications
1. I 2. LS ₀ I 5. LSI 6. LSI _G	2: NSX100/260/250	E: Energy	blank: Distribution G: Generator M: Motors
I: Instantaneous L: Long time (overload) S0: Short time (short-circuit) (fixed time delay) S: Short time (short-circuit) (adjustable time delay) G: Ground Fault	3: NSX400/630		

Full Discriminated sampai downstream breaker Kapasitas Pemutusan
(Grafik tersedia antara Masterpact NW, ComPact NS>630, ComPact NSX, ComPact NSX, Acti9 MCB)
Cascading enhancing the downstream breaker Kapasitas Pemutusan
(Grafik tersedia antara ComPact NSX, ComPact NSX, Acti9 MCB)

Penamaan Referensi Baru

Misalnya LV429630 menjadi C10F3TM100
(ComPacT Breaker NSX100F 36kA AC 3P3D 100A TMD)

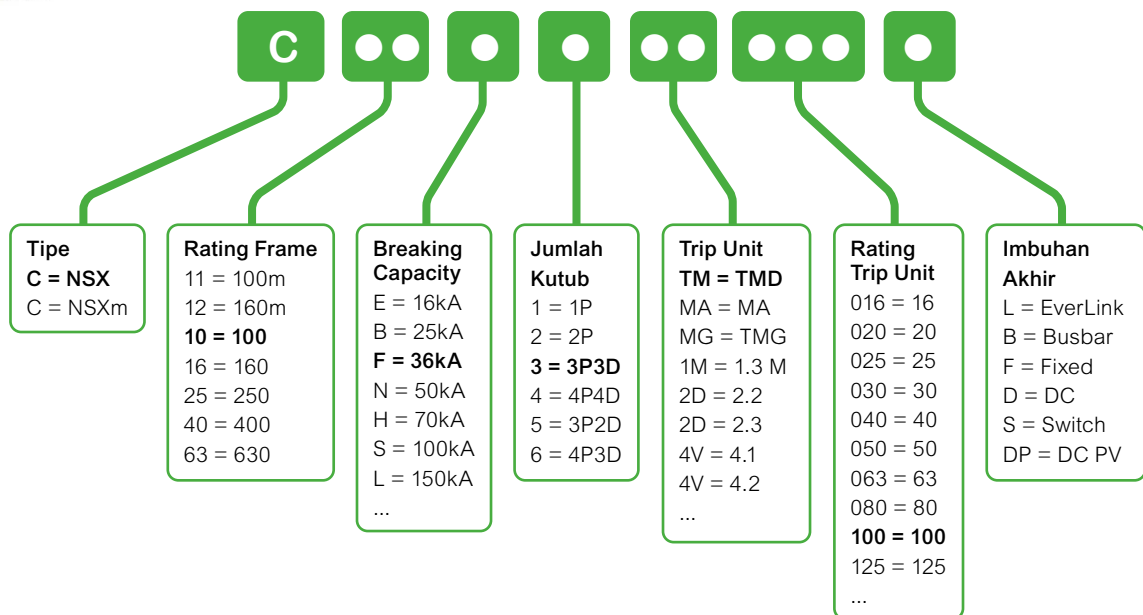

ComPacT NSX

High performance MCCB @ 690 VAC

Menuntut lebih dari sistem tegangan rendah Anda?



Memperkenalkan kapasitas pemutus tinggi untuk



Kelangsungan



Keselamatan



Layanan



High performance MCCB @ 690 VAC
Icu = 100kA @ 690 VAC

■ Kapasitas Pemutus @ 690V

	NSX100	NSX250	NSX400	NSX630
HB2 (100kA)	■	■	■	■
HB1 (75kA)	■	■	■	■
R (45kA)	■	■	■	■

i Untuk ComPacT NSX dengan R / HB1 / HB2, silakan hubungi kami.

Pilih perlindungan yang memberikan

- ✓ Best-in class Kapasitas pemutus untuk:
 -  Marine
 -  Oil & Gas
 -  Mining, Metals, & Minerals
- ✓ Best-in class Type-2 koordinasi untuk motor aplikasi @ 690 VAC.
- ✓ Sertifikasi global.
- ✓ IEC 6094-2 / 4
- ✓ Marine Classifications approvals (Veritas, Lloyd's Register of Shipping, Det Norske Veritas, dll).
- ✓ Standard kelautan, memenuhi persyaratan IACS baru (Ics rating).



FDM121



FDM128



IFM



IFE



I/O

ComPacT NSX ULP Modul (Universal Logic Plug)

■ ULP Modul (Universal Logic Plug)

FDM121 - Front Display Modul

Layar depan modul FDM121 adalah panel yang menunjukkan:

- Pengukuran (Arus, Tegangan, Power, Energi, Power Factor, THD,dll);
- Data pemeliharaan (Contact wear indication, Load Profile, ON/OFF/TRI counter)
- 17 fault sejarah perjalanan / alarm terakhir dengan tanggal & waktu stamping diterima dari MCCB

FDM128 - Switchboard Display

FDM128 adalah tampilan unit display Ethernet yang Mengumpulkan data sampai dengan 8 perangkat melalui jaringan Ethernet dan menunjukkan

- Tampilan Micrologic pengukuran dan perjalanan
- Indikasi Status
- Remote controlditerima dari MCCB

IFM - Modbus Interface Modul

IFM - modul antarmuka Modbus yang memungkinkan unit modular cerdas (IMUs) dalam sistem ULP untuk berkomunikasi menggunakan protokol Modbus. Modul dipasang pada rel DIN

IFE - Ethernet Interface Modul

- IFE Interface: menyediakan akses Ethernet untuk LV circuit breaker tunggal
- IFE Interface + gateway: akses Ethernet ke satu atau beberapa LV circuit breaker
- Tampilan web
- Pemberitahuan alarm melalui E-mail

I/O - Input / Output Interface untuk LV breakers

- 6 Digital Inputs
- 3 Digital Outputs
- 1 Analog Input
- Yang telah ditentukan dan didefinisikan dalam User application



Scan untuk Data Sheet

ComPacT NSX DC

ComPacT NSX PV untuk Aplikasi Fotovoltaik

■ ComPacT NSX PV untuk Aplikasi Fotovoltaik

- Circuit breakers and switch-disconnectors
- Penawaran DC lengkap untuk aplikasi surya dari 80 sampai 1500A
 - 80 ke 500A MCCB dengan TMD tipe trip unit
 - 80 ke 1500A switch disconnectors



Memastikan operasi yang aman dan efisiensi instalasi Fotovoltaik Anda

Dengan heat sink disediakan sebagai standar, Peringkat MCCB adalah dioptimalkan, menghindari kebutuhan untuk perlindungan oversize komponen & menghemat ruang di enclosure.



Koneksi dan isolasi Aksesori disediakan sebagai standar dengan ComPacT NSX PV MCCB adalah:

- Koneksi plate dengan heat sink
- Hulu & hilir perisai terminal

Catatan : untuk ComPacT NSX PV, silakan hubungi kami.





Scan untuk Data Sheet

ComPacT NSX (Proteksi Distribusi) Moulded Case Circuit Breaker 100A s/d 250A

ComPacT NSX100/160/250A F/N/H dengan TMD

Dirancang dengan teknologi pemutusan Roto-Active, memberikan kehandalan dalam "Current Limiting Capacity" ⁽¹⁾

- Arus Nominal (In) : 100A - 250A
- Kapasitas Pemutusan : 36 s/d 70 kA pada 380/415 VAC.
- Ics = 100% Icu.⁽²⁾
- Trip unit :
 - TMD : Thermal (0.7 - 1 x In); Magnetic (5 - 10 x Ir untuk 200 -250A) Untuk proteksi beban distribusi.
- Full Discriminated sampai downstream breaker Kapasitas Pemutusan (charts tersedia)
- Fixed type, front connection.
- Memenuhi standar IEC 60947-2.



ComPacT NSX100F



ComPacT NSX100N



ComPacT NSX100H

Trip Unit	Ir (A)	Im (A)	ComPacT NSX Baru					
			3P	Harga (Rp) (Sebelum PPN)	SS	4P	Harga (Rp) (Sebelum PPN)	SS
ComPacT NSX100 - 250A dengan F (36 kA)								
TM16D	11.2-16	190	C10F3TM016	2.069.000	1 - MTS	C10F6TM016	2.790.000	2 - MTO
TM25D	17.5-25	300	C10F3TM025	2.069.000	1 - MTS	C10F6TM025	2.790.000	2 - MTO
TM32D	22.4-32	400	C10F3TM032	2.069.000	1 - MTS	C10F6TM032	2.790.000	2 - MTO
TM40D	28.0-40	500	C10F3TM040	2.110.000	1 - MTS	C10F6TM040	2.790.000	2 - MTO
TM50D	35.0-50	500	C10F3TM050	2.110.000	1 - MTS	C10F6TM050	2.790.000	1 - MTS
TM63D	44.1-63	500	C10F3TM063	2.239.000	1 - MTS	C10F6TM063	2.874.000	1 - MTS
TM80D	56.0-80	640	C10F3TM080	2.239.000	1 - MTS	C10F6TM080	2.874.000	1 - MTS
TM100D	70.0-100	800	C10F3TM100	2.239.000	1 - MTS	C10F6TM100	2.874.000	1 - MTS
TM125D	87.5-125	1250	C16F3TM125	3.209.000	1 - MTS	C16F6TM125	4.103.000	2 - MTO
TM160D	112-160	1250	C16F3TM160	3.999.000	1 - MTS	C16F6TM160	4.851.000	1 - MTS
TM200D	140-200	5-10 In	C25F3TM200	4.402.000	1 - MTS	C25F6TM200	5.537.000	1 - MTS
TM250D	175-250	5-10 In	C25F3TM250	4.529.000	1 - MTS	C25F6TM250	5.537.000	1 - MTS
ComPacT NSX100 - 250A dengan N (50 kA)								
TM16D	11.2-16	190	C10N3TM016	2.462.000	1 - MTS	C10N6TM016	3.316.000	2 - MTO
TM25D	17.5-25	300	C10N3TM025	2.462.000	1 - MTS	C10N6TM025	3.316.000	2 - MTO
TM32D	22.4-32	400	C10N3TM032	2.462.000	1 - MTS	C10N6TM032	3.316.000	2 - MTO
TM40D	28.0-40	500	C10N3TM040	2.462.000	1 - MTS	C10N6TM040	3.316.000	2 - MTO
TM50D	35.0-50	500	C10N3TM050	2.462.000	1 - MTS	C10N6TM050	3.316.000	2 - MTO
TM63D	44.1-63	500	C10N3TM063	2.536.000	1 - MTS	C10N6TM063	3.416.000	2 - MTO
TM80D	56.0-80	640	C10N3TM080	2.536.000	1 - MTS	C10N6TM080	3.416.000	2 - MTO
TM100D	70.0-100	800	C10N3TM100	2.536.000	1 - MTS	C10N6TM100	3.416.000	1 - MTS
TM125D	87.5-125	1250	C16N3TM125	3.480.000	1 - MTS	C16N6TM125	4.529.000	2 - MTO
TM160D	112-160	1250	C16N3TM160	4.157.000	1 - MTS	C16N6TM160	5.410.000	2 - MTO
TM200D	140-200	5-10 In	C25N3TM200	5.070.000	1 - MTS	C25N6TM200	6.232.000	2 - MTO
TM250D	175-250	5-10 In	C25N3TM250	5.070.000	1 - MTS	C25N6TM250	6.232.000	2 - MTO
ComPacT NSX100 - 250A dengan H (70 kA)								
TM16D	11.2-16	190	C10H3TM016	2.914.000	2 - MTO	C10H6TM016	3.925.000	2 - MTO
TM25D	17.5-25	300	C10H3TM025	2.914.000	2 - MTO	C10H6TM025	3.925.000	2 - MTO
TM32D	22.4-32	400	C10H3TM032	2.914.000	2 - MTO	C10H6TM032	3.925.000	2 - MTO
TM40D	28.0-40	500	C10H3TM040	2.914.000	2 - MTO	C10H6TM040	3.925.000	2 - MTO
TM50D	35.0-50	500	C10H3TM050	2.914.000	2 - MTO	C10H6TM050	3.925.000	2 - MTO
TM63D	44.1-63	500	C10H3TM063	2.999.000	1 - MTS	C10H6TM063	4.042.000	2 - MTO
TM80D	56.0-80	640	C10H3TM080	2.999.000	2 - MTO	C10H6TM080	4.042.000	2 - MTO
TM100D	70.0-100	800	C10H3TM100	2.999.000	1 - MTS	C10H6TM100	4.042.000	2 - MTO
TM125D	87.5-125	1250	C16H3TM125	4.019.000	2 - MTO	C16H6TM125	5.251.000	2 - MTO
TM160D	112-160	1250	C16H3TM160	4.879.000	1 - MTS	C16H6TM160	6.249.000	2 - MTO
TM200D	140-200	5-10 In	C25H3TM200	5.735.000	2 - MTO	C25H6TM200	6.931.000	2 - MTO
TM250D	175-250	5-10 In	C25H3TM250	5.735.000	1 - MTS	C25H6TM250	6.931.000	2 - MTO

Catatan :

- (1) Dengan teknologi ini, arus hubung singkat sebesar 150 kA dapat diputuskan hanya dalam waktu 2 millidetik.
- (2) Ics = Service Breaking Capacity, Icu = Ultimate Breaking Capacity.
 - Untuk S (100kA), L(150kA),R(45kA@690V),HB1(75kA@690V),HB2(100kA@690V) silakan hubungi kami.
 - Untuk other trip unit Micrologic 5.2E/6.2E, silakan hubungi kami.



Scan untuk Data Sheet

ComPacT NSX (Proteksi Distribusi) Moulded Case Circuit Breaker 100A s/d 630A

ComPacT NSX100 - 630A F/N/H dengan Micrologic

Dirancang dengan teknologi pemutusan Roto-Active, memberikan kehandalan dalam "Current Limiting Capacity".⁽¹⁾

- Arus Nominal (In) : 100A - 630A
- Kapasitas Pemutusan : 36 s/d 70 kA pada 380/415 VAC.
- Front Indication LED's (Ready, overload pre-alarm, overload alarm).
- Ics = 100% Icu.⁽²⁾
- Trip unit :
 - Micrologic 2.2/2.3 : Electronic trip unit dengan proteksi LSol untuk beban distribusi Untuk proteksi beban dengan kemampuan diskriminasi diperkuat, memberikan kontinuitas pelayanan sumber daya.
- Full Discriminated sampai downstream breaker Kapasitas Pemutusan (charts tersedia).
- Fixed type, front connection.
- Memenuhi standar IEC 60947-2.
- Adjustable neutral protection - N, N/2, OFF untuk 4 Pole MCCB.



ComPacT NSX100F



ComPacT NSX100N

Trip Unit	Ir (A)	Im (A)	ComPacT NSX Baru					
			3P	Harga (Rp) (Sebelum PPN)	SS	4P	Harga (Rp) (Sebelum PPN)	SS
ComPacT NSX100 - 630A dengan F (36 kA)								
Micrologic 2.2 (40A)	18-40	1.5-10 Ir	C10F32D040	6.038.000	2 - MTO	C10F42D040	7.381.000	2 - MTO
Micrologic 2.2 (100A)	40-100	1.5-10 Ir	C10F32D100	6.038.000	2 - MTO	C10F42D100	7.381.000	2 - MTO
Micrologic 2.2 (160A)	63-160	1.5-10 Ir	C16F32D160	6.385.000	1 - MTS	C16F42D160	7.764.000	2 - MTO
Micrologic 2.2 (250A)	100-250	1.5-10 Ir	C25F32D250	7.350.000	1 - MTS	C25F42D250	9.922.000	2 - MTO
Micrologic 2.3 (400A)	160-400	1.5-10 Ir	C40F32D400	8.677.000	1 - MTS	C40F42D400	10.484.000	1 - MTS
Micrologic 2.3 (630A)	250-630	1.5-10 Ir	C63F32D630	13.082.000	1 - MTS	C63F42D630	19.125.000	1 - MTS
ComPacT NSX100 - 630A dengan N (50 kA)								
Micrologic 2.2 (40A)	18-40	1.5-10 Ir	C10N32D040	7.969.000	2 - MTO	C10N42D040	7.969.000	2 - MTO
Micrologic 2.2 (100A)	40-100	1.5-10 Ir	C10N32D100	6.641.000	2 - MTO	C10N42D100	7.969.000	2 - MTO
Micrologic 2.2 (160A)	63-160	1.5-10 Ir	C16N32D160	7.003.000	2 - MTO	C16N42D160	9.123.000	2 - MTO
Micrologic 2.2 (250A)	100-250	1.5-10 Ir	C25N32D250	7.901.000	2 - MTO	C25N42D250	10.290.000	2 - MTO
Micrologic 2.3 (400A)	160-400	1.5-10 Ir	C40N32D400	11.327.000	1 - MTS	C40N42D400	14.698.000	1 - MTS
Micrologic 2.3 (630A)	250-630	1.5-10 Ir	C63N32D630	14.886.000	1 - MTS	C63N42D630	20.240.000	1 - MTS
ComPacT NSX100 - 630A dengan H (70 kA)								
Micrologic 2.2 (40A)	18-40	1.5-10 Ir	C10H32D040	8.020.000	2 - MTO	C10H42D040	8.937.000	2 - MTO
Micrologic 2.2 (100A)	40-100	1.5-10 Ir	C10H32D100	8.020.000	2 - MTO	C10H42D100	8.937.000	2 - MTO
Micrologic 2.2 (160A)	63-160	1.5-10 Ir	C16H32D160	8.259.000	2 - MTO	C16H42D160	10.282.000	2 - MTO
Micrologic 2.2 (250A)	100-250	1.5-10 Ir	C25H32D250	8.695.000	2 - MTO	C25H42D250	10.766.000	2 - MTO
Micrologic 2.3 (400A)	160-400	1.5-10 Ir	C40H32D400	13.299.000	1 - MTS	C40H42D400	16.850.000	2 - MTO
Micrologic 2.3 (630A)	250-630	1.5-10 Ir	C63H32D630	17.275.000	1 - MTS	C63H42D630	22.227.000	2 - MTO

Catatan :

- (1) Dengan teknologi ini, arus hubung singkat sebesar 150 kA dapat diputuskan hanya dalam waktu 2 milidetik.
- (2) Ics = Service Breaking Capacity, Icu = Ultimate Breaking Capacity.
 - Untuk S (100kA), L(150kA),R(45kA@690V),HB1(75kA@690V),HB2(100kA@690V) silakan hubungi kami
 - Untuk other trip unit Micrologic 5.2E/6.2E, silakan hubungi kami

Micrologic 5E / 6E (energi metering tertanam)

Arus, Tegangan, Power, Energi, Power factor, THD, maintenance parameters,dll

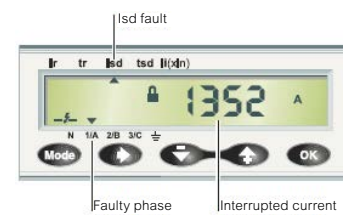
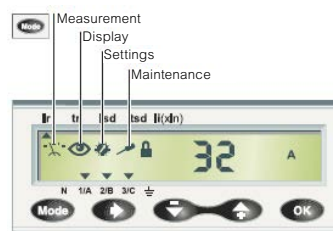

Display of interrupted current.



Scan untuk Data Sheet

ComPacT NSX (Proteksi Motor) Moulded Case Circuit Breaker 100A s/d 630A

■ ComPacT NSX100 - 630A F/N/H dengan MA / Micrologic 1.3M

Dirancang dengan teknologi pemutusan Roto-Active, memberikan kehandalan dalam "Current Limiting Capacity". ⁽¹⁾

- Untuk proteksi motor sampai 250 kW (400V, 50Hz).
- Trip unit MA hanya untuk proteksi hubung singkat.
- Ics = 100% x Icu as per IEC 60947-2.
- Rated at 65°C as per motor standards.
- Tipe -2 co-ordinasi 3 device (NSX MA/1.3M + TeSys D Kontactor + LRD relay).



ComPacT NSX
Proteksi Motor

Compact	Im (A)	ComPacT NSX Baru		
		Referensi	Harga (Rp) (Sebelum PPN)	SS
ComPacT NSX100 - 630A dengan F (36kA), 3P				
MA (Proteksi Hubung Singkat) 6.3A	6-14 x In	C10F3MA007	5.382.000	2 - MTO
MA (Proteksi Hubung Singkat) 12.5A	6-14 x In	C10F3MA013	5.382.000	2 - MTO
MA (Proteksi Hubung Singkat) 25A	6-14 x In	C10F3MA025	5.382.000	2 - MTO
MA (Proteksi Hubung Singkat) 50A	6-14 x In	C10F3MA050	5.382.000	2 - MTO
MA (Proteksi Hubung Singkat) 100A	6-14 x In	C10F3MA100	5.463.000	1 - MTS
MA (Proteksi Hubung Singkat) 150A	9-14 x In	C16F3MA150	4.251.000	2 - MTO
MA (Proteksi Hubung Singkat) 220A	9-14 x In	C25F3MA220	6.049.000	2 - MTO
Micrologic 1.3M (Proteksi Hubung Singkat) 320A	5-13 x In	C40F31M320	17.647.000	2 - MTO
Micrologic 1.3M (Proteksi Hubung Singkat) 500A	5-13 x In	C63F31M500	23.074.000	2 - MTO
ComPacT NSX100 - 630A dengan N (50kA), 3P				
MA (Proteksi Hubung Singkat) 2.5A	6-14 x In	C10N3MA003	6.540.000	2 - MTO
MA (Proteksi Hubung Singkat) 6.3A	6-14 x In	C10N3MA007	6.540.000	2 - MTO
MA (Proteksi Hubung Singkat) 12.5A	6-14 x In	C10N3MA013	6.540.000	2 - MTO
MA (Proteksi Hubung Singkat) 25A	6-14 x In	C10N3MA025	6.540.000	2 - MTO
MA (Proteksi Hubung Singkat) 50A	6-14 x In	C10N3MA050	6.055.000	2 - MTO
MA (Proteksi Hubung Singkat) 100A	6-14 x In	C10N3MA100	6.055.000	2 - MTO
MA (Proteksi Hubung Singkat) 150A	9-14 x In	C16N3MA150	5.308.000	1 - MTS
MA (Proteksi Hubung Singkat) 220A	9-14 x In	C25N3MA220	6.791.000	2 - MTO
Micrologic 1.3M (Proteksi Hubung Singkat) 320A	5-13 x In	C40N31M320	20.506.000	2 - MTO
Micrologic 1.3M (Proteksi Hubung Singkat) 500A	5-13 x In	C63N31M500	31.150.000	2 - MTO
ComPacT NSX100 - 630A dengan H (70kA), 3P				
MA (Proteksi Hubung Singkat) 2.5A	6-14 x In	C10H3MA003	8.079.000	2 - MTO
MA (Proteksi Hubung Singkat) 6.3A	6-14 x In	C10H3MA007	8.079.000	2 - MTO
MA (Proteksi Hubung Singkat) 12.5A	6-14 x In	C10H3MA013	8.079.000	2 - MTO
MA (Proteksi Hubung Singkat) 25A	6-14 x In	C10H3MA025	8.079.000	2 - MTO
MA (Proteksi Hubung Singkat) 50A	6-14 x In	C10H3MA050	8.079.000	2 - MTO
MA (Proteksi Hubung Singkat) 100A	6-14 x In	C10H3MA100	8.079.000	2 - MTO
MA (Proteksi Hubung Singkat) 150A	9-14 x In	C16H3MA150	6.327.000	2 - MTO
MA (Proteksi Hubung Singkat) 220A	9-14 x In	C25H3MA220	7.821.000	2 - MTO
Micrologic 1.3M (Proteksi Hubung Singkat) 320A	5-13 x In	C40H31M320	23.409.000	2 - MTO
Micrologic 1.3M (Proteksi Hubung Singkat) 500A	5-13 x In	C63H31M500	34.218.000	2 - MTO

Catatan : Untuk S (100kA), L(150kA),R(45kA@690V),HB1(75kA@690V),HB2(100kA@690V) silahkan hubungi kami.





Scan untuk Data Sheet



Electronic Trip Unit Micrologic 2.2-M

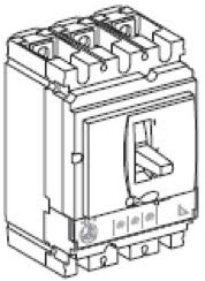

Micrologic 6 E-M

ComPacT NSX (Proteksi Motor) Moulded Case Circuit Breaker 100A s/d 630A

■ ComPacT NSX100 - 630A F/N/H dengan Micrologic 2.2 M / 2.3M

- Untuk proteksi motor sampai 250 kW (400V, 50Hz).
- Electronic trip unit untuk proteksi hubung singkat dan beban lebih.
- Trip class selection: Class 5, Class 10 & Class 20
- Tahap unbalance Dan fase Rugi
- Tipe 2 co-ordinasi charts 2 device (NSX Micrologic 2.2/2.3M + TeSys D Kontaktor) sampai 315kW @ 400V
- Front Indication LED's (Ready dan temperature rise alarm)
- Perlindungan netral yang dapat diatur - N, N/2, OFF untuk 4 Pole MCCB
- Rated @ 65°C sesuai standar bermotor

Compact	I _r (A)	kW	I _m	ComPacT NSX Baru		
				Referensi	Harga (Rp) (Sebelum PPN)	SS
ComPacT NSX100 - 630A dengan F (36kA), 3P						
Micrologic 2.3-M 320A	160-320	160	5-13 x I _r	C40F32M320	14.148.000	2 - MTO
Micrologic 2.3-M 500A	250-500	250	5-13 x I _r	C63F32M500	18.590.000	2 - MTO
ComPacT NSX100 - 630A dengan N (50kA), 3P						
Micrologic 2.3-M 320A	160-320	160	5-13 x I _r	C40N32M320	21.932.000	2 - MTO
Micrologic 2.3-M 500A	250-500	250	5-13 x I _r	C63N32M500	32.407.000	2 - MTO
ComPacT NSX100 - 630A dengan H (70kA), 3P						
Micrologic 2.2-M 25A	12-25	9	5-13 x I _r	C10H32M025	8.218.000	2 - MTO
Micrologic 2.2-M 50A	25-50	18,5	5-13 x I _r	C10H32M050	9.108.000	2 - MTO
Micrologic 2.2-M 100A	50-100	45	5-13 x I _r	C10H32M100	9.108.000	2 - MTO
Micrologic 2.2-M 150A	70-150	75	5-13 x I _r	C16H32M150	9.945.000	2 - MTO
Micrologic 2.2-M 220A	100-220	110	5-13 x I _r	C25H32M220	13.324.000	2 - MTO
Micrologic 2.3-M 320A	160-320	160	5-13 x I _r	C40H32M320	25.764.000	2 - MTO
Micrologic 2.3-M 500A	250-500	250	5-13 x I _r	C63H32M500	37.656.000	2 - MTO

■ Parameters dari Micrologic 6 E-M

- Overload, Short-circuit dan Earth-fault protection
- Ketidakseimbangan fasa atau kehilangan fasa
- Trip Class selection: Class 5, Class10, Class 20 dan Class 30
- Cooling Fan selection: self cooled atau fan cooled motors
- Ketidakseimbangan arus: 10 - 40% x rata-rata saat ini dan waktu tunda
- Terkunci rotor: 1 - 8 x I_r dan waktu tunda
- Di bawah beban (arus bawah): 0.3 - 0.9 x I_r dan waktu tunda
- Long Starts: 1 - 8 x I_r dan waktu tunda
- Neutral: OFF atau 0.5xI_r atau 1xI_r atau oversized neutral (1.6xI_r)
- Front Indication LED's (Ready dan Temperature rise alarm)
- Zone Selective Interlocking (ZSI)
- Fault distinction pada layar unit perjalanan (tipe dari fault, interrupted fault current dan faulty phase)
- Tertanam metering (Arus, Tegangan, energi, power, power factor, total harmonic distortion,)
- Preventive & Predictive Maintenance (waktu untuk perjalanan, kontak pakai, profil beban, dll)

Catatan : Untuk ComPacT NSX dengan Micrologic 6 E-M, silahkan hubungi kami.



Scan untuk Data Sheet

ComPacT NSX (Proteksi Distribusi - Arus Bocor)

Moulded Case Circuit Breaker 100A s/d 630A

ComPacT NSX100 - 630A F/N/H dengan Micrologic Vigi 4 (Earth Leakage Protection)

Dirancang dengan teknologi pemutusan Roto-Active, memberikan kehandalan dalam "Current Limiting Capacity" ⁽¹⁾

- Arus Nominal (In) : 100A - 630A
- Kapasitas Pemutusan : 36 s/d 70 kA pada 380/415 VAC.
- Ics = 100% Icu. ⁽²⁾
- Trip unit :
 - Micrologic Vigi 4: Electronic trip unit dengan proteksi LSolR untuk beban distribusi dan arus bocor Untuk proteksi beban dengan kemampuan diskriminasi diperkuat, memberikan kontinuitas pelayanan sumber daya.
- Full Discriminated sampai downstream breaker Kapasitas Pemutusan (grafik tersedia)
- Fixed type, front connection.
- Memenuhi standar IEC 60947-2.
- Adjustable neutral protection - N, N/2, OFF untuk 4 Pole MCCB



ComPacT NSX100F Vigi



ComPacT NSX400H Vigi

Trip Unit	Ir (A)	Im (A)	ComPacT NSX Baru					
			3P	Harga (Rp) (Sebelum PPN)	SS	4P	Harga (Rp) (Sebelum PPN)	SS
ComPacT NSX100 - 630A dengan F (36 kA)								
Micrologic Vigi 4.2	18-40	1.5-10 Ir	C10F34V040	12.697.000	2 - MTO	C10F44V040	16.489.000	2 - MTO
Micrologic Vigi 4.2	40-100	1.5-10 Ir	C10F34V100	12.697.000	2 - MTO	C10F44V100	16.489.000	2 - MTO
Micrologic Vigi 4.2	63-160	1.5-10 Ir	C16F34V160	13.624.000	2 - MTO	C16F44V160	16.861.000	2 - MTO
Micrologic Vigi 4.2	100-250	1.5-10 Ir	C25F34V250	16.460.000	2 - MTO	C25F44V250	23.807.000	2 - MTO
Micrologic Vigi 4.3	160-400	1.5-10 Ir	C40F34V400	26.494.000	2 - MTO	C40F44V400	28.869.000	2 - MTO
Micrologic Vigi 4.3	250-630	1.5-10 Ir	C63F34V570	30.163.000	2 - MTO	C63F44V570	37.108.000	2 - MTO
ComPacT NSX100 - 630A dengan N (50 kA)								
Micrologic Vigi 4.2	18-40	1.5-10 Ir	C10N34V040	13.258.000	2 - MTO	C10N44V040	17.062.000	2 - MTO
Micrologic Vigi 4.2	40-100	1.5-10 Ir	C10N34V100	13.258.000	2 - MTO	C10N44V100	17.062.000	2 - MTO
Micrologic Vigi 4.2	63-160	1.5-10 Ir	C16N34V160	13.548.000	2 - MTO	C16N44V160	17.327.000	2 - MTO
Micrologic Vigi 4.2	100-250	1.5-10 Ir	C25N34V250	18.282.000	2 - MTO	C25N44V250	24.161.000	2 - MTO
Micrologic Vigi 4.3	160-400	1.5-10 Ir	C40N34V400	27.914.000	2 - MTO	C40N44V400	34.417.000	2 - MTO
Micrologic Vigi 4.3	250-630	1.5-10 Ir	C63N34V570	32.153.000	2 - MTO	C63N44V570	38.147.000	2 - MTO
ComPacT NSX100 - 630A dengan H (70 kA)								
Micrologic Vigi 4.2	18-40	1.5-10 Ir	C10H34V040	14.544.000	2 - MTO	C10H44V040	17.155.000	2 - MTO
Micrologic Vigi 4.2	40-100	1.5-10 Ir	C10H34V100	14.544.000	2 - MTO	C10H44V100	18.012.000	2 - MTO
Micrologic Vigi 4.2	63-160	1.5-10 Ir	C16H34V160	14.708.000	2 - MTO	C16H44V160	19.325.000	2 - MTO
Micrologic Vigi 4.2	100-250	1.5-10 Ir	C25H34V250	19.006.000	2 - MTO	C25H44V250	24.616.000	2 - MTO
Micrologic Vigi 4.3	160-400	1.5-10 Ir	C40H34V400	29.142.000	2 - MTO	C40H44V400	34.986.000	2 - MTO
Micrologic Vigi 4.3	250-630	1.5-10 Ir	C63H34V570	32.846.000	2 - MTO	C63H44V570	39.997.000	2 - MTO

Catatan :

- (1) Dengan teknologi ini, arus hubung singkat sebesar 150 kA dapat diputuskan hanya dalam waktu 2 millidetik.
- (2) Ics = Service Breaking Capacity, Icu = Ultimate Breaking Capacity.
 - Untuk S (100kA), L(150kA),R(45kA@690V),HB1(75kA@690V),HB2(100kA@690V) silakan hubungi kami.



Scan untuk Data Sheet



ComPacT NSX (Proteksi DC Network) Moulded Case Circuit Breaker 100A s/d 630A

ComPacT NSX100 - 630A dengan TMD - DC

Range - 16A to 1200A dengan TMD trip unit

- Trip unit MA hanya untuk proteksi hubung singkat.
- Memenuhi standar IEC 60947-2.
- Kapasitas Pemutusan: upto 100kA.

Poles	Kapasitas Pemutusan	NSX100	NSX160	NSX250	NSX400	NSX630		NSX1200	
		16A-100A	125A-160A	200A-250A	250-400A	500A	630A	630A-1200A	
3P/4P	F 36kA @750VDC	█							
3P/4P	S 100kA @750VDC	█							
3P/4P	F 36kA @500VDC						█		
3P/4P	S 100kA @500VDC						█		
2P	F 36kA @500VDC	█							
2P	M 85kA @500VDC	█							
2P	S 100kA @500VDC	█							
2P	N 50kA @600VDC							█	
1P	F 36kA @250VDC	█							
1P	N 50kA @250VDC	█							
1P	M 85kA @250VDC	█							

Trip Unit	I _r (A)	ComPacT NSX Baru					
		3P	Harga (Rp) <i>(Sebelum PPN)</i>	SS	4P	Harga (Rp) <i>(Sebelum PPN)</i>	SS
ComPacT NSX DC F (36kA)							
TMD DC	250	C40F3TM250D	21.964.000	2 - MTO	C40F4TM250D	25.259.000	2 - MTO
	320	C40F3TM320D	22.931.000	2 - MTO	C40F4TM320D	25.259.000	2 - MTO
	400	C40F3TM400D	23.112.000	2 - MTO	C40F4TM400D	26.580.000	2 - MTO
	500	C63F3TM500D	22.383.000	2 - MTO	C63F4TM500D	25.740.000	2 - MTO
	600	C63F3TM600D	24.842.000	2 - MTO	C63F4TM600D	28.568.000	2 - MTO
ComPacT NSX DC S (100kA)							
TMD DC	250	C40S3TM250D	22.868.000	2 - MTO	C40S4TM250D	26.310.000	2 - MTO
	320	C40S3TM320D	22.878.000	2 - MTO	C40S4TM320D	26.310.000	2 - MTO
	400	C40S3TM400D	24.502.000	2 - MTO	C40S4TM400D	28.177.000	2 - MTO
	500	C63S3TM500D	24.502.000	2 - MTO	C63S4TM500D	28.177.000	2 - MTO
	600	C63S3TM600D	24.521.000	2 - MTO	C63S4TM600D	28.199.000	2 - MTO

Catatan :

- Untuk ComPacT NSX DC dengan rating arus di bawah 250A dapat dilakukan pembelian frame dan trip unit secara terpisah dengan menghubungi kami.
- Untuk ComPacT NSX dengan 1P / 2P, silahkan hubungi kami.



Auxiliary Contact



SDTAM



SDx



Voltage Release

ComPacT NSX

Aksesori EasyPact™ CVS100-630 (exclude 100BS) & ComPacT NSX100-630

Kontak Bantu & Voltage Release

■ Kontak Bantu

Memberikan petunjuk mengenai penyebab terputusnya pemutus tenaga.

- **OF** : Menunjukkan status circuit breaker, tertutup (ON) atau terbuka (OFF).
- **SD** : Menunjukkan circuit breaker trip karena beban lebih, hubung singkat, gangguan tanah, bekerjanya voltage release, operasi tombol push-to trip
- **SDE** : Menunjukkan circuit breaker trip karena beban lebih, hubung singkat, gangguan tanah (Vigi, Micrologic 6).
- **SDV** : Menunjukkan circuit breaker trip karena adanya gangguan tanah (earth fault).
- **SDx** : Output module untuk trip unit Micrologic yang menunjukkan indikasi gangguan beban lebih.
- **SDTAM** : Menunjukkan gangguan beban lebih, kehilangan fase, dll (Micrologic 6 seri M atau proteksi motor).

Type	NSX 100-250			NSX 400-630		
	Referensi	Harga (Rp) (Sebelum PPN)	SS	Referensi	Harga (Rp) (Sebelum PPN)	SS
OF/SD/SDE/SDV	29450	570.000	1 - MTS	29450	570.000	1 - MTS
Adaptor SDE untuk trip unit TM / MA / Micrologic 2/1.3M (<i>harus diorder bersama SDE ref. 29450</i>)	LV429451	234.000	1 - MTS	sudah terpasang		
SDx Module	LV429532	3.295.000	2 - MTO	LV429532	3.295.000	2 - MTO
SDTAM 24/415 V AC/DC Indikasi Gangguan Beban Lebih	LV429424	4.183.000	2 - MTO	LV429424	4.183.000	2 - MTO

Type	CVS 100-250			CVS 400-630		
	Referensi	Harga (Rp) (Sebelum PPN)	SS	Referensi	Harga (Rp) (Sebelum PPN)	SS
OF/SD/SDE/SDV	29450	570.000	1 - MTS	29450	570.000	1 - MTS
Adaptor SDE untuk trip unit TM / MA / ETS2.3 (<i>harus diorder bersama SDE ref. 29450</i>)	LV429451	234.000	1 - MTS	LV540050	310.000	1 - MTS

■ Voltage Release

- **MN** : Under voltage release, mentriapkan circuit breaker saat tegangan kontrol jatuh di bawah batas yang ditentukan (antara 0,35 - 0,7 Un).
- **MX** : Shunt trip, mentriapkan circuit breaker saat tegangan kontrol mencapai 0,7 Un.

Tegangan Kontrol (V)	MX	Harga (Rp) (Sebelum PPN)	SS	MN	Harga (Rp) (Sebelum PPN)	SS
AC 50/60 Hz	24	LV429384	1.428.000	2 - MTO	LV429406	1.904.000
	110/130	LV429386	1.428.000	2 - MTO		
	200/240	LV429387	1.428.000	1 - MTS		
	380/415 (50 Hz)	LV429388	1.428.000	2 - MTO		
DC	525 (50 Hz)	LV429389	1.428.000	2 - MTO	LV429408	1.904.000
	12	LV429382	1.428.000	2 - MTO		
	24	LV429390	1.428.000	2 - MTO		
	30	LV429391	1.428.000	2 - MTO		
	48	LV429392	1.428.000	2 - MTO		
	125	LV429393	1.428.000	2 - MTO		
	250	LV429394	1.428.000	2 - MTO		
	MN 220/240 VAC dengan tunda waktu (untuk MN 250 V DC LV429414)					
				LV429427	4.331.000	



Motor Mechanism 100/160/250



Motor Mechanism 400/630

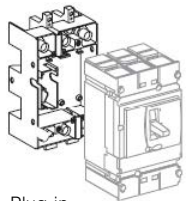

Plug-in Configuratio

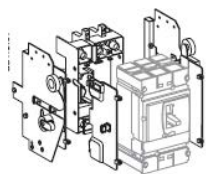

Withdrawable Configuratio

ComPacT NSX

Aksesori EasyPact™ CVS100-630 (exclude 100BS) & ComPacT NSX100-630 Motor Mechanism, Plug-in dan Withdrawable

Motor Mechanism

- Membuka dan menutup circuit breaker secara otomatis.
- Digunakan pada automatic source changeover system.

Motor Mechanism 100/160/250

Tegangan (V)	MT100/160	Harga (Rp) (Sebelum PPN)	SS	MT250	Harga (Rp) (Sebelum PPN)	SS	
AC 50/60Hz	48/60			LV431548	14.162.000	2 - MTO	
	220/240	LV429434	8.715.000	1 - MTS	LV431541	9.656.000	1 - MTS
	380/415	LV429435	8.715.000	2 - MTO	LV431542	9.656.000	2 - MTO
DC	24/30			LV431543	13.425.000	2 - MTO	
	48/60	LV429437	11.610.000	2 - MTO			
	110/130	LV429438	11.610.000	2 - MTO	LV431545	13.425.000	2 - MTO
	250	LV429439	11.610.000	2 - MTO	LV431546	13.425.000	2 - MTO

Motor Mechanism 400/630

Tegangan (V)	MT400/630	Harga (Rp) (Sebelum PPN)	SS	
AC 50/60Hz	48/60	LV432639	19.815.000	2 - MTO
	110/130	LV432640	19.815.000	2 - MTO
	220/240	LV432641	19.815.000	1 - MTS
	380/415 (50 Hz)	LV432642	19.815.000	2 - MTO
DC	24/30	LV432643	21.911.000	2 - MTO
	48/60	LV432644	21.911.000	2 - MTO
	110/130	LV432645	21.911.000	2 - MTO
	250	LV432646	21.911.000	2 - MTO

Catatan : Kontak SDE wajib untuk digunakan saat menggunakan mekanisme bermotor

Aksesori ComPacT NSX

Plug-in Configuration

Memungkinkan untuk mengganti dan memasang kembali circuit breaker dengan cepat tanpa menyentuh sambungan daya.

Plug-in Kit	3P	Harga (Rp) (Sebelum PPN)	SS	4P	Harga (Rp) (Sebelum PPN)	SS
NSX100/160/250 ComPact	LV429289	2.734.000	1 - MTS	LV429290	4.402.000	2 - MTO
NSX400/630 ComPact	LV432538	5.887.000	2 - MTO	LV432539	7.903.000	2 - MTO

Plug-in kit terdiri dariudukan (base), safety trip, short terminal shield dan koneksi daya.

Withdrawable Configuration

- Semua kelebihan plug-in configuration tercakup pada withdrawable configuratio
- Pada posisi disconnected, daya instalasi terputus, tapi circuit breaker masih berada pada chassis dan dapat dioperasikan (ON, OFF, push-to-trip).

Withdrawable kit	3P	Harga (Rp) (Sebelum PPN)	SS	4P	Harga (Rp) (Sebelum PPN)	SS	
NSX100/160/250	Plug-in kit	1 x LV429289	2.734.000	1 - MTS	1 x LV429290	4.402.000	2 - MTO
	Chassis side plates for base	1 x LV429282	2.321.000	1 - MTS	1 x LV429282	2.321.000	1 - MTS
	Chassis side plates for breaker	1 x LV429283	1.102.000	1 - MTS	1 x LV429283	1.102.000	1 - MTS
NSX400/630	Plug-in kit	1 x LV432538	5.887.000	2 - MTO	1 x LV432539	7.903.000	2 - MTO
	Chassis side plates for base	1 x LV432532	2.713.000	2 - MTO	1 x LV432532	2.713.000	2 - MTO
	Chassis side plates for breaker	1 x LV432533	1.224.000	2 - MTO	1 x LV432533	1.224.000	2 - MTO

Withdrawable kit terdiri dari plug-in kit + fixed part chassis + moving part chassis

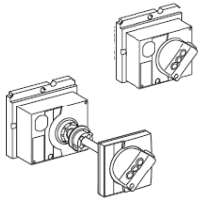

Rotary Handle

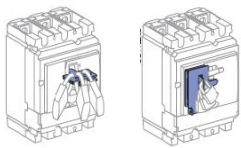

Locking



Aksesori Koneksi

ComPacT NSX

Aksesori EasyPact™ CVS100-630 (exclude 100BS) & ComPacT NSX100-630
Rotary Handle, Locking, & Aksesori Koneksi

Aksesori EasyPact CVS & ComPacT NSX

Rotary Handle

- Tetap menjaga indikasi 3 posisi : O (OFF), I (ON) dan trip.
- Fungsi isolasi masih tetap terjaga.
- Circuit breaker dapat dikunci pada posisi OFF dengan gembok.

Rotary Handle	NSX100/250			NSX400/630		
	Referensi	Harga (Rp) (Sebelum PPN)	SS	Referensi	Harga (Rp) (Sebelum PPN)	SS
Direct rotary handle						
Standar, handel hitam	LV429337T	832.000	1 - MTS	LV432597T	1.380.000	1 - MTS
Extended rotary handle						
Standar, handel hitam	LV429338T	1.326.000	1 - MTS	LV432598T	2.051.000	1 - MTS
Telescopic handle untuk tipe withdrawable	LV429343T	1.792.000	2 - MTO	LV432603T	2.434.000	2 - MTO

Locking

Locking	NSX100/250			NSX400/630		
	Referensi	Harga (Rp) (Sebelum PPN)	SS	Referensi	Harga (Rp) (Sebelum PPN)	SS
Toggle locking device untuk 1-3 gembok (gembok tidak disupply)						
Removable device	29370	246.000	2 - MTO	29370	246.000	2 - MTO
Fixed device	LV429371T	537.000	2 - MTO	LV432631	827.000	2 - MTO
Locking untuk rotary handle						
Keylock adapter (tanpa keylock)	LV429344	300.000	2 - MTO	LV432604	374.000	2 - MTO
Keylock Ronis 1351B.500	41940	2.163.000	2 - MTO	41940	2.163.000	2 - MTO
Keylock Profalux KS5 B24 D4Z	42888	2.184.000	2 - MTO	42888	2.184.000	2 - MTO

Catatan : Hanya bisa dipasang pada produk NSX

tidak boleh diorder terpisah dan harus dirakit oleh PT Schneider Indonesia atau pihak yang mendapat izin resmi.

Aksesori Koneksi

Locking	NSX100/250			NSX400/630		
	Referensi	Harga (Rp) (Sebelum PPN)	SS	Referensi	Harga (Rp) (Sebelum PPN)	SS
Spreader						
Spreader 3P	LV431563	348.000	2 - MTO			
35-45 mm 4P	LV431564	433.000	2 - MTO			
Spreader 3P				LV432490	953.000	1 - MTS
52.5 mm 4P				LV432491	1.308.000	2 - MTO
Spreader 3P				LV432492	1.459.000	2 - MTO
70 mm 4P				LV432493	1.910.000	2 - MTO
Terminal Shield						
Pendek 3P 1 psg	LV429515	213.000	2 - MTO	LV432591	467.000	2 - MTO
Pendek 4P 1 psg	LV429516	562.000	2 - MTO	LV432592	731.000	2 - MTO
Panjang 3P 1 psg	LV429517	233.000	2 - MTO	LV432593	556.000	2 - MTO
Panjang 4P 1 psg	LV429518	600.000	2 - MTO	LV432594	731.000	2 - MTO
Inter phase barrier						
6	LV429329	341.000	1 - MTS	LV432570	372.000	2 - MTO



BSCM



FDM121

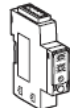

Modbus Interface



NSX Cord



10 stacking connector



10 Modbus line terminator



RS 485



5 RJ45



10 ULP line terminator



RJ45



Modul catu daya eksternal

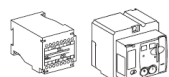

Modul catu daya eksternal 24 VDC 0 1 A OVC IV

ComPacT NSX

Aksesori ComPacT NSX

Monitor dan Kontrol

■ Monitor dan Kontrol

Untuk melakukan komunikasi antara ComPacT NSX dan sistem monitor secara remote, dibutuhkan beberapa komponen bantu tambahan.

Tipe	Referensi	Harga (Rp) (Sebelum PPN)	SS
Aksesori CB			
BSCM (Breaker Status Control Module)	LV434205	2.477.000	2 - MTO
Display Module ULP			
FDM121 (Front Display Module)	TRV00121	4.522.000	2 - MTO
Aksesori pemasangan FDM (dia. 22 mm)	TRV00128	180.000	2 - MTO
Aksesori ULP (Universal Logic Plug)			
IFM Modbus interface module	LV434000	2.556.000	2 - MTO
NSX Cord L = 1,3 m	LV434201	1.905.000	2 - MTO
NSX Cord L = 3 m	LV434202	1.498.000	2 - MTO
10 stacking connector untuk interface komunikasi	TRV00217	2.711.000	2 - MTO
10 Modbus line terminator	VW3A8306DRC	208.000	2 - MTO
5 RJ45 connectors female/female	TRV00870	1.172.000	2 - MTO
10 ULP line terminator	TRV00880	419.000	2 - MTO
10 RJ45/RJ45 male cord L = 0,6 m	TRV00806	1.410.000	2 - MTO
5 RJ45/RJ45 male cord L = 1 m	TRV00810	860.000	2 - MTO
5 RJ45/RJ45 male cord L = 2 m	TRV00820	1.482.000	2 - MTO
Modul Catu Daya			
Modul catu daya eksternal 24 VDC - 1 A OVC IV : 200-240 V A	LV454444	5.540.000	2 - MTO
Modul Baterai			
24 VDC modul baterai	54446	6.970.000	2 - MTO
Motor Mechanism dengan komunikasi			
MTc 100/160 220-240 V 50/60 Hz	LV429441	12.519.000	2 - MTO
MTc 250 220-240 V 50/60 Hz	LV431549	13.829.000	2 - MTO
MTc 400/630 220-240 V 50/60 Hz	LV432652	22.570.000	2 - MTO



Scan untuk Data Sheet

ComPact NS

Moulded Case Circuit Breaker 800 s/d 1600A

NEW! Compact NS800/1600 N/H/L Manually Operated

Memberikan petunjuk mengenai penyebab terputusnya pemutus tenaga.

- Arus Nominal (In) : 800-1600A
- Kapasitas Pemutusan : 50 s/d 150 kA pada 220/415 VAC.
- Trip unit :
 - **Micrologic 2.0** : Electronic trip unit standar untuk proteksi beban distribusi.
 - **Micrologic 5.0** : Electronic trip unit untuk proteksi beban distribusi dengan penguat diskriminasi.
- Fixed type, front connection.
- Memenuhi standar IEC 60947-2.



Rating (A)	Ics (% of Icu)	Model	Tipe Baru					
			3P	Harga (Rp) <i>(Sebelum PPN)</i>	SS	4P	Harga (Rp) <i>(Sebelum PPN)</i>	SS
Fixed front connected Micrologic 2.0								
Compact NS type N. Icu = 50kA at 220/415 Vac								
800A	100%	NS800N	C080N320FM	22.182.000	1 - MTS	C080N420FM	33.430.000	2 - MTO
1000A	100%	NS1000N	C100N320FM	26.200.000	2 - MTO	C100N420FM	37.695.000	2 - MTO
1250A	100%	NS1250N	C125N320FM	34.204.000	1 - MTS	C125N420FM	44.223.000	2 - MTO
1600A	75%	NS1600N	C160N320FM	46.114.000	2 - MTO	C160N420FM	57.641.000	2 - MTO
Compact NS type H. Icu = 70kA at 220/415 Vac								
800A	75%	NS800H	C080H320FM	24.644.000	2 - MTO	C080H420FM	36.273.000	2 - MTO
1000A	75%	NS1000H	C100H320FM	28.821.000	2 - MTO	C100H420FM	38.470.000	2 - MTO
1250A	75%	NS1250H	C125H320FM	43.944.000	2 - MTO	C125H420FM	51.025.000	2 - MTO
1600A	75%	NS1600H	C160H320FM	50.730.000	2 - MTO	C160H420FM	63.407.000	2 - MTO
Compact NS type L. Icu = 150kA at 220/415 Vac								
800A	100%	NS800L	C080L320FM	44.080.000	2 - MTO	C080L420FM	76.286.000	2 - MTO
1000A	100%	NS1000L	C100L320FM	54.810.000	2 - MTO	C100L420FM	90.584.000	2 - MTO
Fixed front connected Micrologic 2.0 E								
Compact NS type N. Icu = 50kA at 220/415 Vac								
800A	100%	NS800N	C080N32EFM	28.836.000	2 - MTO	C080N42EFM	43.459.000	2 - MTO
1000A	100%	NS1000N	C100N32EFM	34.060.000	2 - MTO	C100N42EFM	49.004.000	2 - MTO
1250A	100%	NS1250N	C125N32EFM	44.465.000	2 - MTO	C125N42EFM	57.490.000	2 - MTO
1600A	75%	NS1600N	C160N32EFM	59.948.000	2 - MTO	C160N42EFM	74.934.000	2 - MTO
Compact NS type H. Icu = 70kA at 220/415 Vac								
800A	75%	NS800H	C080H32EFM	32.037.000	2 - MTO	C080H42EFM	47.154.000	2 - MTO
1000A	75%	NS1000H	C100H32EFM	37.467.000	2 - MTO	C100H42EFM	50.011.000	2 - MTO
1250A	75%	NS1250H	C125H32EFM	57.127.000	2 - MTO	C125H42EFM	66.332.000	2 - MTO
1600A	75%	NS1600H	C160H32EFM	65.948.000	2 - MTO	C160H42EFM	82.429.000	2 - MTO
Fixed front connected Micrologic 5.0 E								
Compact NS type N. Icu = 50kA at 220/415 Vac								
800A	100%	NS800N	C080N35EFM	31.054.000	2 - MTO	C080N45EFM	46.802.000	2 - MTO
1000A	100%	NS1000N	C100N35EFM	36.680.000	2 - MTO	C100N45EFM	52.773.000	2 - MTO
1250A	100%	NS1250N	C125N35EFM	47.885.000	2 - MTO	C125N45EFM	61.913.000	2 - MTO
1600A	100%	NS1600N	C160N35EFM	64.560.000	2 - MTO	C160N45EFM	80.698.000	2 - MTO
Compact NS type H. Icu = 70kA at 220/415 Vac								
800A	75%	NS800H	C080H35EFM	34.502.000	2 - MTO	C080H45EFM	50.781.000	2 - MTO
1000A	75%	NS1000H	C100H35EFM	40.349.000	2 - MTO	C100H45EFM	53.858.000	2 - MTO
1250A	75%	NS1250H	C125H35EFM	61.521.000	2 - MTO	C125H45EFM	71.435.000	2 - MTO
1600A	75%	NS1600H	C160H35EFM	71.021.000	2 - MTO	C160H45EFM	88.770.000	2 - MTO

Catatan :

- Silahkan hubungi kami untuk informasi lebih lanjut mengenai :
Tipe instalasi drawout untuk Compact NS800/160

Moulded Case Circuit Breaker (MCCB)

PPCCB

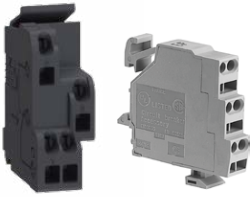

Auxiliary/ Indication Contact



Voltage Release



Rotary Handle

ComPact NS

Aksesori ComPact NS800-NS1600

Kontak Bantu

■ Kontak Bantu

Memberikan petunjuk mengenai penyebab terputusnya pemutus tenaga.

- **OF** : Menunjukkan status circuit breaker, tertutup (ON) atau terbuka (OFF).
- **SD** : Menunjukkan circuit breaker trip karena beban lebih, hubung singkat, arus bocor, bekerjanya voltage release, dll.
- **SDE** : Menunjukkan circuit breaker trip karena beban lebih, hubung singkat, arus bocor.

ComPact	Kontak Bantu	Referensi	Harga (Rp) (Sebelum PPN)	SS
NS630b/3200 Fixed type	OF, SD, SDE	29450	570.000	1 - MTS
	OF	33801	1.131.000	2 - MTO
NS630b/1600 Drawout type	SD	33800	793.000	2 - MTO
	SDE	33799	809.000	2 - MTO
	CE, CD, CT	33170	752.000	2 - MTO

■ Voltage Release

- **MN** : Under voltage release, mentriapkan circuit breaker saat tegangan kontrol jatuh di bawah batas yang ditentukan (antara 0,35 - 0,7 Un).
- **MX** : Shunt trip, mentriapkan circuit breaker saat tegangan kontrol mencapai 0,7 Un.

ComPact	Teg. Kontrol (V)	MX	Harga (Rp) (Sebelum PPN)	SS	MN	Harga (Rp) (Sebelum PPN)	SS
NS800/3200 Fixed type	24-30 V AC/DC	33659	2.738.000	2 - MTO	33668	3.402.000	2 - MTO
	48-60 V AC/DC	33660	2.738.000	2 - MTO	33669	3.402.000	2 - MTO
	110-130 V AC/DC	33661	2.740.000	2 - MTO	33670	3.402.000	2 - MTO
	200-250 V AC/DC	33662	2.738.000	2 - MTO	33671	3.402.000	2 - MTO
	380-480 V AC	33664	2.659.000	2 - MTO	33673	3.402.000	2 - MTO
NS800/1600 Drawout type	110-130 V AC/DC	33812	2.833.000	2 - MTO	33821	3.524.000	2 - MTO
	200-250 V AC/DC	33813	2.833.000	2 - MTO	33822	3.517.000	2 - MTO

ComPact	Teg. Kontrol (V)	Unit tunda waktu untuk MN					
		R (Non-adjust)	Harga (Rp) (Sebelum PPN)	SS	Rr (Adjustable)	Harga (Rp) (Sebelum PPN)	SS
NS800/3200	200-250 V AC/DC	33685	4.757.000	2 - MTO	33682	3.818.000	2 - MTO

■ Rotary Handle

Rotary Handle		NS800/1600	Harga (Rp) (Sebelum PPN)	SS
Direct rotary handle	Handel hitam	33863	2.120.000	2 - MTO
Extended rotary handle	Handel hitam	33878	4.583.000	2 - MTO
Mechanical interlocking	Untuk 2 CB dengan extended rotary handle	33890	3.597.000	2 - MTO

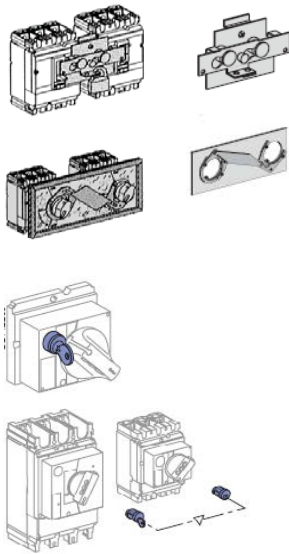

Manual Source Changeover

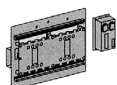

Plate

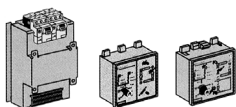

Automatic Controller

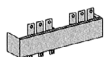

Downstream Coupling Accessory

Source Changeover System

ComPacT NSX100 - 630 Manual & Automatic

Manual Source Changeover

Jenis		Referensi	Harga (Rp) (Sebelum PPN)	SS
Mechanical interlocking				
untuk CB dengan toggle	NSX100/160/250	LV429354	2.511.000	2 - MTO
	NSX400/630	LV432614	3.086.000	2 - MTO
untuk CB dengan rotary handle	NSX100/160/250	LV429369	2.954.000	2 - MTO
	NSX400/630	LV432621	3.316.000	2 - MTO
Keylock interlocking				
untuk CB dengan rotary handle				
Keylock kit (tanpa keylock)	NSX100/160/250	LV429344	300.000	2 - MTO
untuk satu breaker	NSX400/630	LV432604	374.000	2 - MTO
2 locks, 1 key	Ronis 1351.500	41950	2.183.000	2 - MTO

Automatic Source Changeover

Automatic Source Changeover (Automatic Transfer Switch - ATS) untuk ComPacT NSX100/630 tersusun dari:

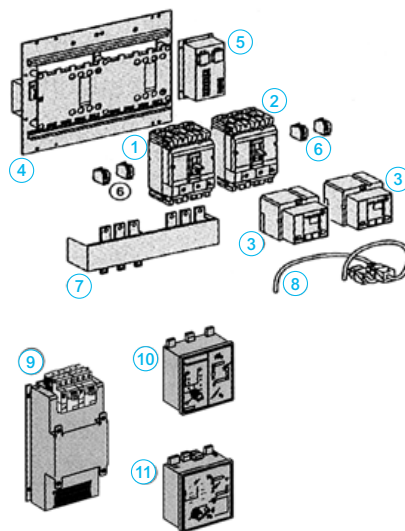

- 1 Sumber 'Normal'.
- 2 Sumber 'Pengganti'.
- 3 Motor Mechanism (2 buah, masing-masing untuk sumber 'Normal' dan 'Pengganti').
- 4 Plate dengan interlocking.
- 5 IVE (electrical interlocking unit).
- 6 Auxiliary switches : 2x (1 OF + 1 SDE)
- 7 Downstream coupling accessory (sebagai pilihan).
- 8 Kabel IVE.
- 9 ACP (auxiliary control plate).
- 10 BA control unit, atau
- 11 UA control unit.

Catatan :

- Tegangan supply IVE, ACP, BA/UA dan Motor harus sama.
- Harus diperhatikan juga, jika :
 - Circuit breaker 'Normal' tidak sama dengan 'Pengganti' maka pilihlah accessories adaptor kit.
 - Circuit breaker yang digunakan berupa jenis plug-in/ withdrawable, silakan menghubungi kami.

Plate + IVE

CB 'Normal'	CB 'Pengganti'		Harga (Rp) (Sebelum PPN)	SS
NSX100...250				
Plate + IVE (lengkap dengan kabel IVE)	NSX100...250	29350	22.639.000	2 - MTO
Safety Trip Interlock Link		LV429270	281.000	2 - MTO
Auxiliary switches 2 OF + 2 SDE		29450	570.000	1 - MTS
NSX400...630				
Plate + IVE (lengkap dengan kabel IVE)	NSX400...630	32610	26.872.000	2 - MTO
Auxiliary switches 2 OF + 2 SDE		29450	570.000	1 - MTS

Automatic Controller

Controller	220/240 VAC	Harga (Rp) (Sebelum PPN)	SS	380/415 VAC	Harga (Rp) (Sebelum PPN)	SS
ACP + control unit BA	29470	38.725.000	2 - MTO	29471	40.082.000	2 - MTO
ACP + control unit UA	29472	50.820.000	2 - MTO	29473	49.208.000	2 - MTO

Downstream Coupling Accessory

CB 'Normal'	CB 'Pengganti'	Poles	Referensi	Harga (Rp) (Sebelum PPN)	SS
NSX100...250	NSX100...250	3P	LV429358	11.739.000	2 - MTO
NSX400...630	NSX400...630	3P	LV432619	12.659.000	2 - MTO
		4P	LV432620	17.339.000	2 - MTO



Scan untuk Data Sheet

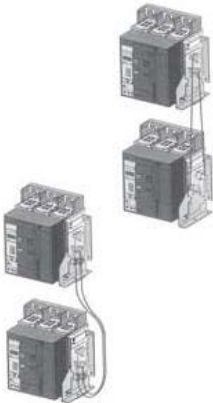

Interlocking System



IVE Electrical Interlocking Unit



Automatic Controller

Source Changeover System

ComPacT NS800 - 1600 Manual & Automatic

Manual Source Changeover

Mechanical interlocking	Referensi	Harga (Rp) (Sebelum PPN)	SS
CB dengan extended rotary handle	33890	3.597.000	2 - MTO

Automatic Source Changeover

Automatic Source Changeover (Automatic Transfer Switch - ATS) untuk ComPacT NSX100/630 tersusun dari:

- 1 Sumber 'Normal' lengkap dengan motor mech dan alat bantu (auxiliary contact)
- 2 Sumber 'Pengganti' lengkap dengan motor mech dan alat bantu (auxiliary contact)
- 3 Interlocking system dengan batang rigid (rod) atau kabel 4 = IVE (electrical interlocking unit)
- 4 IVE (electrical interlocking unit)
- 5 ACP (auxiliary control plate)
- 6 BA atau UA controller

Catatan :

- Setiap circuit breaker harus dilengkapi dengan 1 motor mech, 1 OF, 1 SDE (dan 1 CE untuk tipe drawout).
- Tegangan supply IVE, ACP, BA/UA dan Motor mech harus sama.

Interlocking System

CB 'Normal'	Referensi	Harga (Rp) (Sebelum PPN)	SS
Interlocking dengan kabel			
untuk 2 CB fixed type	33911	17.929.000	2 - MTO
untuk 2 CB drawout type	33914	18.426.000	2 - MTO

IVE Electrical Interlocking Unit

IVE		Harga (Rp) (Sebelum PPN)	SS
IVE untuk 2 CB	29352	11.026.000	2 - MTO
Wiring kit untuk menghubungkan CB dengan IVE	54655	4.035.000	2 - MTO

Automatic Controller

Controller	220/240 VAC		SS	380/415 VAC		SS
	Harga (Rp) (Sebelum PPN)			Harga (Rp) (Sebelum PPN)		
ACP + control unit BA	29470	38.725.000	2 - MTO	29471	40.082.000	2 - MTO
ACP + control unit UA	29472	50.820.000	2 - MTO	29473	49.208.000	2 - MTO



Scan untuk Data Sheet

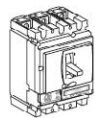

ComPact NSX-NA

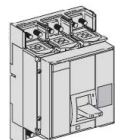

ComPact NS-NA



Scan untuk Data Sheet

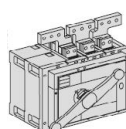
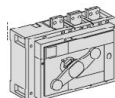

ComPact INS

Switch Disconnecter ComPact - NSX NA, NS NA, INS

ComPact NSX-NA, NS-NA

- Memenuhi standar IEC 60947-3.
- Memiliki fungsi isolasi dan kontrol.
- Dapat dilengkapi fungsi tambahan (proteksi arus bocor, motor mechanism, trip jarak jauh).
- Memiliki accessories yang sama dengan ComPact NSX/NS standar.

Type	Rating (A)	3P Tipe Lama			3P Tipe Baru		
		Referensi	Harga (Rp) (Sebelum PPN)	SS	Referensi	Harga (Rp) (Sebelum PPN)	SS
NSX100NA	100	LV429629	4.064.000	2 - MTO	C103100S	3.710.000	2 - MTO
NSX250NA	250	LV431629	6.232.000	2 - MTO	C253250S	5.690.000	2 - MTO
NSX400NA	400	LV432756	16.451.000	2 - MTO	C403400S	15.020.000	2 - MTO
NSX630NA	630	LV432956	23.838.000	2 - MTO	C633630S	21.765.000	2 - MTO
NS800NA	800	33487	29.361.000	2 - MTO	C080S3NAFM	21.743.000	2 - MTO
NS1000NA	1000	33488	32.148.000	2 - MTO	C100S3NAFM	31.200.000	2 - MTO
NS1250NA	1250	33489	62.261.000	2 - MTO	C125S3NAFM	32.760.000	2 - MTO

ComPact INS

- Memenuhi standar IEC 60947-3.
- Memiliki fungsi isolasi dan kontrol.
- Dilengkapi dengan direct rotary handle.
- Memiliki Positive Contact Indication untuk menjamin posisi switch.

Type	Rating (A)	3P	Harga (Rp) (Sebelum PPN)	SS	4P	Harga (Rp) (Sebelum PPN)	SS
Compact INS (versi standar dengan tuas hitam)							
INS40	40	28900	1.204.000	1 - MTS	28901	1.450.000	2 - MTO
INS63	63	28902	1.401.000	1 - MTS	28903	1.548.000	1 - MTS
INS80	80	28904	1.606.000	2 - MTO			
INS100	100	28908	2.274.000	2 - MTO	28909	2.524.000	1 - MTS
INS125	125	28910	2.149.000	1 - MTS	28911	2.370.000	2 - MTO
INS160	160	28912	2.758.000	1 - MTS	28913	2.964.000	2 - MTO
INS250	250	31106	4.561.000	2 - MTO	31107	4.644.000	2 - MTO
INS320	320	31108	9.658.000	2 - MTO	31109	10.072.000	2 - MTO
INS400	400	31110	9.844.000	2 - MTO	31111	10.362.000	2 - MTO
INS500	500	31112	10.040.000	2 - MTO	31113	10.569.000	2 - MTO
INS630	630	31114	10.455.000	2 - MTO	31115	11.524.000	2 - MTO
INS800	800	31330	33.502.000	2 - MTO	31331	37.411.000	2 - MTO
INS1000	1000	31332	35.020.000	2 - MTO	31333	38.881.000	2 - MTO
INS1250	1250	31334	35.212.000	2 - MTO	31335	39.096.000	2 - MTO
INS1600	1600	31336	36.961.000	2 - MTO	31337	45.401.000	2 - MTO
INS2000	2000	31338	73.883.000	2 - MTO	31339	94.869.000	2 - MTO
INS2500	2500	31340	77.187.000	2 - MTO	31341	98.259.000	2 - MTO

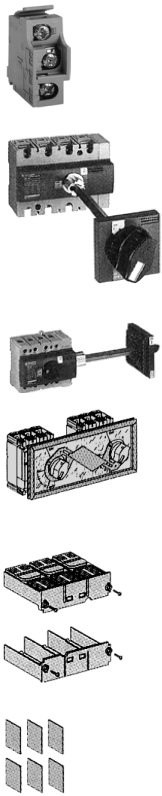

Accessories
Interpact INS/INV

Switch Disconnecter

Aksesori ComPact INS

■ Compact INS 40/2500

Accessories		Qty	Referensi	Harga (Rp) <i>(Sebelum PPN)</i>	SS
Auxiliary contact OF			29450	570.000	1 - MTS
Extended rotary handle	front - black handle		INS40/160	LV428941	608.000 2 - MTO
			INS250, INV100/250	LV431050	1.115.000 2 - MTO
			INS/INV 320/630	31052	1.920.000 2 - MTO
Terminal shield	pendek		INS250, INV100/250	1 psg LV429516	562.000 2 - MTO
			INS/INV 320/630	1 psg LV432592	731.000 2 - MTO
	panjang		INS250, INV100/250	1 psg LV429518	600.000 2 - MTO
			INS/INV 320/630	1 psg LV432594	731.000 2 - MTO
Phase barrier			INS250, INV100/250	6 LV429329	341.000 1 - MTS
			INS/INV 320/630	6 LV432570	372.000 2 - MTO



Scan untuk Data Sheet



RH21M (DIN-rail Mount)



RH99M (DIN-rail Mount)



RH99P (Front Panel Mount)



Proteksi Arus Bocor Bumi Relay Arus Bocor Vigirex dan Toroida

■ Tipe RH10 M/P dengan reset fault secara lokal manual

- Jenis jaringan : LV ≤ 1000 V 50/60/400 Hz
- Sensitivitas : 0,03A / 0,05A / 0,1A / 0,15A / 0,25A / 0,3A / 0,5A / 1A
- Waktu tunda : 0 detik

Tegangan Supply		RH 10M (DIN-rail mount)		
		Referensi	Harga (Rp) (Sebelum PPN)	SS
Sensitivitas (IΔn) = 1 A Instantaneous				
220/240 VAC	50/60 Hz	56137	5.442.000	2 - MTO

■ Tipe RH21 M/P dengan reset fault secara lokal manual

- Jenis jaringan : LV ≤ 1000 V 50/60/400 Hz
- Sensitivitas : 0,03 A - Instantaneous (0 detik)
- Waktu tunda : 0,3 A - Instantaneous (0 detik) atau waktu tunda 0,06 detik

Tegangan Supply		RH 21M (DIN-rail mount)			RH 21P (Front-panel mount)		
		Referensi	Harga (Rp) (Sebelum PPN)	SS	Referensi	Harga (Rp) (Sebelum PPN)	SS
220/240 VAC	50/60 Hz	56163	6.177.000	2 - MTO			
380/415 VAC	50/60 Hz	56164	5.940.000	2 - MTO	56264	7.490.000	2 - MTO

■ Tipe RH99 M/P dengan reset fault secara lokal manual

- Jenis jaringan : LV ≤ 1000 V 50/60/400 Hz
- Sensitivitas : 0,03 A - 30 A
- Waktu tunda : Instantaneous (0 detik) atau 0 - 4,5 detik

Tegangan Supply		RH 99M (DIN-rail mount)			RH 99P (Front-panel mount)		
		Referensi	Harga (Rp) (Sebelum PPN)	SS	Referensi	Harga (Rp) (Sebelum PPN)	SS
12/24 VAC . 12/48 VDC	50/60 Hz	56170	9.212.000	2 - MTO	56270	9.678.000	2 - MTO
110/130 VAC	50/60 Hz	56172	8.023.000	2 - MTO	56272	8.724.000	2 - MTO
220/240 VAC	50/60 Hz	56173	8.023.000	2 - MTO	56273	8.724.000	2 - MTO
380/415 VAC	50/60 Hz	56174	8.141.000	2 - MTO	56274	8.724.000	2 - MTO

Toroida	Tipe	Diameter (mm)	Referensi	Harga (Rp) (Sebelum PPN)	SS
Toroida tertutup tipe A	TA30	30	50437	1.756.000	1 - MTS
	PA50	50	50438	2.659.000	2 - MTO
	IA80	80	50439	3.705.000	2 - MTO
	MA120	120	50440	5.024.000	2 - MTO
	SA200	200	50441	7.560.000	2 - MTO
	GA300	300	50442	14.117.000	2 - MTO
Toroida terbuka tipe OA	TOA 80	80	50420	21.745.000	2 - MTO
	TOA 120	120	50421	38.069.000	2 - MTO



MWF 3200
BOTTOM

SERVICE DISCONNECT
DESCONEXIÓN DE ALIMENTACIÓN
SECTIONNEUR DE SERVICE

Push OFF

Push ON

EasyPact™ MVS	7-3
EasyPact MVS - Easy Choice for Reliable Performance	7-3
EasyPact MVS - Selection Guide	7-4
EasyPact MVS - ETA / ETV Trip System	7-5
EasyPact MVS N (50kA) + Electronic Trip 2.0A	7-6
EasyPact MVS N (50kA) + Electronic Trip 5.0A	7-7
EasyPact MVS H (65kA) + Electronic Trip 2.0A	7-8
EasyPact MVS H (65kA) + Electronic Trip 5.0A	7-9
EasyPact MVS T (85kA) + Electronic Trip 2.0A/5.0A	7-10
Aksesori Kontak Bantu	7-11
Aksesori Remote Control	7-12
MasterPact™ MTZ	7-13
MasterPact MTZ - Selection Guide, Introduction	7-13
MasterPact MTZ - Micrologic Trip Unit	7-15
MasterPact MTZ2/3 Tipe H1 + Micrologic 2.0X (Manually Operated)	7-16
MasterPact MTZ2/3 Tipe H1 + Micrologic 2.0X (Electrically Operated)	7-17
MasterPact MTZ2/3 Tipe H2 + Micrologic 2.0X (Manually Operated)	7-18
MasterPact MTZ2/3 Tipe H2 + Micrologic 2.0X (Electrically Operated)	7-19
Micrologic X Trip Unit & Digital Module (dirakit oleh PT Schneider Indonesia)	7-20
Aksesori (dirakit oleh PT Schneider Indonesia)	7-21
Aksesori (Spares) / dibeli terpisah	7-23
Source Changeover System (COS)	7-27
Automatic Source Changeover (Masterpact MTZ)	7-27
Smart Panel	7-28
Introduction	7-28
Enerlin'X	7-30



EasyPact™ MVS

EasyPact MVS dengan

- Satu frame size 800A ke 4000A.
- MVS range $I_{cu} = I_{cs} = I_{cw}_{(1 \text{ sec})}$ @440VAC.
- Trip unit dilengkapi dengan ammeter / voltmeter.
- Trip unit dengan memory thermal sesuai standar.
- 5.0A / 6.0A dengan ZSI (zone selective interlocking) sesuai standar.
- Sesuai untuk aplikasi hingga 690VAC.
- Orientasi terminal fleksibel memungkinkan perubahan keselarasan horizontal atau vertikal di bidang hingga 3200A.
- Dimensi, Mounting & Aksesori yang sama dengan Masterpact NW.



■ Pedoman Pilihan

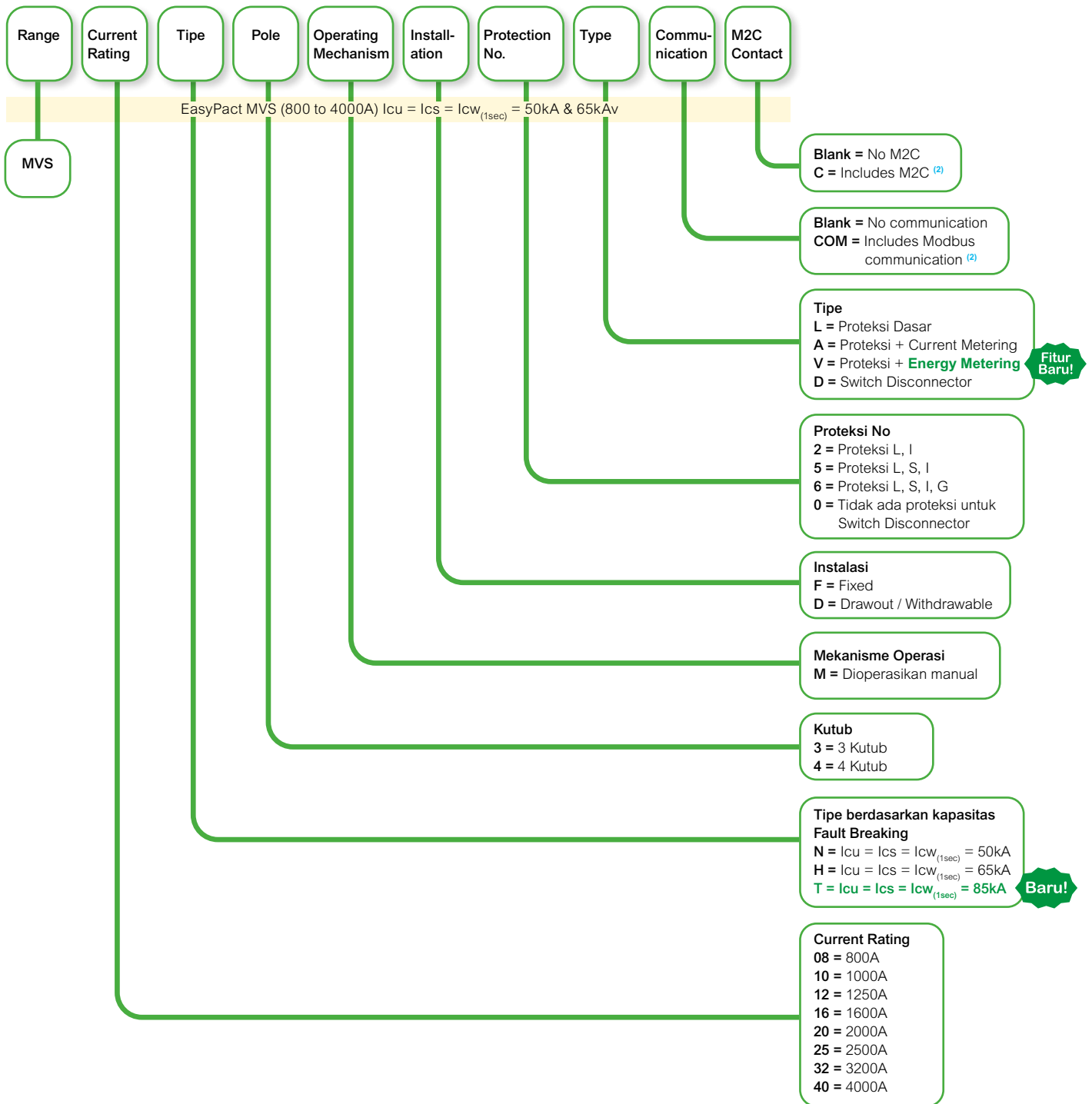

Contoh 1 : MVS08N3MD2A

MVS	08	N	3	M	D	2	A
EasyPact MVS	800A	50kA	3 Pole	Manual	Drawout	LI Protection	Current Metering

Contoh 2 : MVS12N4MF5VCOMC

MVS	12	N	4	M	F	5	V	COM (2)	C (2)
EasyPact MVS	1250A	50kA	4 Pole	Manual	Fixed	LSI Protection	Current, Voltage, Energy Metering	COM	M2C contact

Catatan :

- (1) Untuk EasyPact MVS dengan versi elektronik, silakan pesan Motor mechanism + XF (Closing release) + MX (Opening release) secara terpisah.
- (2) COM Module & M2C Contact hanya tersedia untuk Trip unit ETV

EasyPact™ MVS ETA/ ETV Trip System

A step towards Intelligent Electrical Distribution Network



ETA trip unit



ETV trip unit

ETA/ ETV Trip System

Electronic Trip unit memiliki setelan :

- 2.0A/5.0A/6.0A/2.0V/5.0V/6.0V: long time protection (proteksi beban lebih) : $I_r = 0.4 I_n$ s/d I_n dengan 9 setelan.
- 2.0A/5.0A/6.0A/2.0V/5.0V/6.0V: time delay untuk long time protection (t_l).
- 2.0A/5.0A/6.0A/2.0V/5.0V/6.0V: instantaneous protection (proteksi hubung singkat) : $I_{sd} = 1.5 I_r$ s/d $10 I_r$ dengan 9 setelan.
- 5.0A/6.0A/5.0V/6.0V: time delay untuk short time protection (t_{sd})
- 5.0A/6.0A/5.0V/6.0V: Instantaneous protection $I_i = 2 I_n$ s/d $15 I_n + 'off'$, dengan 9 setelan.
- 6.0A/6.0V: earth fault protection $I_g = 0.3 I_n$ s/d I_n , dengan 9 setelan.
- 6.0A/6.0V: time delay untuk earth fault protection (t_g)

Features	ETA Trip Unit dilengkapi dengan ammeter⁽¹⁾ untuk menampilkan besar arus tiap fase.	ETV Trip Unit dilengkapi dengan Energy Meter untuk menampilkan besar energy, opsi modul komunikasi dan M2C contact
ZSI (zone selective interlocking)	✓ (5A/6A)	✓ (5V/6V)
% loading bar graph for each phase	✓	✓
Thermal memory	✓	✓
Current Metering	✓	✓
Voltage Metering	x	✓
NEW Power & Energy	x	✓
NEW Break Status/Trip Record	x	✓
NEW Eco Communication	x	Optional
NEW M2C	x	Optional

Info tambahan yang disediakan oleh rangkaian ETV range trip units

- ✓ Demand current
- ✓ Demand current maximeter
- ✓ Phase to phase voltages
- ✓ Phase to neutral voltages
- ✓ Average voltage
- ✓ Voltage unbalance
- ✓ Trip history
- ✓ **Power & Energy Metering**
- ✓ **Optional Com Module**
- ✓ **Optional M2C Contact**

Air Circuit Breaker (ACB)

PPACB



EasyPact MVS



ET 2.0A/5.0A/6.0A

EasyPact™ MVS Tipe N Air Circuit Breaker 800 s/d 4000A 50kA

EasyPact MVS N (50kA) + Electronic Trip 2.0A

- Arus nominal : 800A s/d 4000A.
- Kapasitas Pemutusan : **50 kA** pada 380/440V.
- Icu = Ics = Icw untuk 1sec.
- Built in thermal memory.
- Zone selective interlocking (ZSI) dengan 5.0A/6.0A/5.0V/6.0V.
- Tidak ada derating sampai dengan 50°C.
- Trip unit Electronic Trip **2.0A**, memiliki setelan :
 - Long time protection (proteksi beban lebih) : **$I_r = 0.4 I_n$ s/d I_n** dengan 9 setelan.
 - Time delay untuk long time protection (**t_l**).
 - instantaneous protection (proteksi hubung singkat) : **$I_{sd} = 1.5 I_r$ s/d $10 I_r$** dengan 9 setelan.
- **ETA** Dilengkapi dengan **ammeter⁽¹⁾** untuk menampilkan besar arus tiap fase.
- 3 atau 4 kutub, fixed atau drawout type.
- Memenuhi standar IEC 60947-2.
- Dinilai penuh netral dengan perlindungan inbuilt

Spesifikasi standar

- Mekanisme pegas dengan sistem energi tersimpan.
- Horizontal rear connection.
- Auxiliary switches (4 changeover contact OF + SDE).
- Arc chute cover, **door frame**, dan safety shutter untuk drawout type.

	In (A)	Icu (kA)	3P			4P		
			Referensi	Harga (Rp) (Sebelum PPN)	SS	Referensi	Harga (Rp) (Sebelum PPN)	SS
Tipe Fixed								
MVS08	800	50	MVS08N3MF2A	34.257.000	1 - MTS	MVS08N4MF2A	42.072.000	1 - MTS
MVS10	1000	50	MVS10N3MF2A	36.786.000	1 - MTS	MVS10N4MF2A	45.103.000	1 - MTS
MVS12	1250	50	MVS12N3MF2A	37.514.000	1 - MTS	MVS12N4MF2A	46.363.000	1 - MTS
MVS16	1600	50	MVS16N3MF2A	42.044.000	1 - MTS	MVS16N4MF2A	52.514.000	1 - MTS
MVS20	2000	50	MVS20N3MF2A	47.059.000	1 - MTS	MVS20N4MF2A	61.544.000	1 - MTS
MVS25	2500	50	MVS25N3MF2A	60.814.000	1 - MTS	MVS25N4MF2A	72.038.000	1 - MTS
MVS32	3200	50	MVS32N3MF2A	67.265.000	1 - MTS	MVS32N4MF2A	85.090.000	1 - MTS
MVS40	4000	50	MVS40N3MF2A	120.230.000	2 - MTO	MVS40N4MF2A	143.875.000	2 - MTO
Tipe Drawout								
MVS08	800	50	MVS08N3MD2A	45.434.000	1 - MTS	MVS08N4MD2A	67.407.000	2 - MTO
MVS10	1000	50	MVS10N3MD2A	47.963.000	2 - MTO	MVS10N4MD2A	70.886.000	2 - MTO
MVS12	1250	50	MVS12N3MD2A	48.693.000	2 - MTO	MVS12N4MD2A	73.934.000	2 - MTO
MVS16	1600	50	MVS16N3MD2A	62.462.000	2 - MTO	MVS16N4MD2A	80.083.000	2 - MTO
MVS20	2000	50	MVS20N3MD2A	69.323.000	2 - MTO	MVS20N4MD2A	95.234.000	2 - MTO
MVS25	2500	50	MVS25N3MD2A	83.077.000	2 - MTO	MVS25N4MD2A	110.854.000	2 - MTO
MVS32	3200	50	MVS32N3MD2A	89.528.000	2 - MTO	MVS32N4MD2A	123.905.000	2 - MTO
MVS40	4000	50	MVS40N3MD2A	156.851.000	2 - MTO	MVS40N4MD2A	195.143.000	2 - MTO

Catatan :

(1) Apabila arus < 20% In, harus ditambahkan external power supply AD module agar ammeter dapat berfungsi.



EasyPact MVS



ET 2.0A/5.0A/6.0A

EasyPact™ MVS Tipe N

Air Circuit Breaker 800 s/d 4000A 50kA

■ EasyPact MVS N (50kA) + Electronic Trip 5.0A

- Arus nominal : 800A s/d 4000A.
- Kapasitas Pemutusan : **50 kA** pada 380/440V.
- Icu = Ics = Icw untuk 1sec.
- Built in thermal memory.
- Zone selective interlocking (ZSI) dengan 5.0A/6.0A/5.0V/6.0V.
- Tidak ada derating sampai dengan 50°C.
- Trip unit Electronic Trip **5.0A**, memiliki setelan :
 - long time protection (proteksi beban lebih) : **Ir = 0.4 In s/d In** dengan 9 setelan.
 - time delay untuk long time protection (t_r).
 - instantaneous protection (proteksi hubung singkat) : **I_{sd} = 1.5 Ir s/d 10 Ir** dengan 9 setelan.
 - time delay untuk short time protection (t_{sd})
 - Instantaneous protection **li = 2 In s/d 15 In + 'off'**, dengan 9 setelan.
- **ETA** Dilengkapi dengan **ammeter⁽¹⁾** untuk menampilkan besar arus tiap fase.
- 3 atau 4 kutub, fixed atau drawout type.
- Memenuhi standar IEC 60947-2.
- Dinilai penuh netral dengan perlindungan inbuilt

Spesifikasi standar

- Mekanisme pegas dengan sistem energi tersimpan.
- Horizontal rear connection.
- Auxiliary switches (4 changeover contact OF + SDE).
- Arc chute cover, **door frame**, dan safety shutter untuk drawout type.

	In (A)	Icu (kA)	3P			4P		
			Referensi	Harga (Rp) <i>(Sebelum PPN)</i>	SS	Referensi	Harga (Rp) <i>(Sebelum PPN)</i>	SS
Tipe Fixed								
MVS08	800	50	MVS08N3MF5A	45.722.000	2 - MTO	MVS08N4MF5A	52.818.000	2 - MTO
MVS10	1000	50	MVS10N3MF5A	47.242.000	2 - MTO	MVS10N4MF5A	56.281.000	2 - MTO
MVS12	1250	50	MVS12N3MF5A	48.693.000	2 - MTO	MVS12N4MF5A	57.539.000	2 - MTO
MVS16	1600	50	MVS16N3MF5A	52.086.000	2 - MTO	MVS16N4MF5A	64.144.000	2 - MTO
MVS20	2000	50	MVS20N3MF5A	58.046.000	2 - MTO	MVS20N4MF5A	70.107.000	2 - MTO
MVS25	2500	50	MVS25N3MF5A	71.799.000	2 - MTO	MVS25N4MF5A	82.602.000	2 - MTO
MVS32	3200	50	MVS32N3MF5A	78.479.000	2 - MTO	MVS32N4MF5A	95.653.000	2 - MTO
MVS40	4000	50	MVS40N3MF5A	130.686.000	2 - MTO	MVS40N4MF5A	149.201.000	2 - MTO
Tipe Drawout								
MVS08	800	50	MVS08N3MD5A	56.589.000	2 - MTO	MVS08N4MD5A	78.584.000	2 - MTO
MVS10	1000	50	MVS10N3MD5A	59.140.000	2 - MTO	MVS10N4MD5A	82.913.000	2 - MTO
MVS12	1250	50	MVS12N3MD5A	59.869.000	2 - MTO	MVS12N4MD5A	81.899.000	2 - MTO
MVS16	1600	50	MVS16N3MD5A	74.136.000	2 - MTO	MVS16N4MD5A	87.816.000	2 - MTO
MVS20	2000	50	MVS20N3MD5A	80.544.000	2 - MTO	MVS20N4MD5A	107.261.000	2 - MTO
MVS25	2500	50	MVS25N3MD5A	90.697.000	2 - MTO	MVS25N4MD5A	122.881.000	2 - MTO
MVS32	3200	50	MVS32N3MD5A	101.633.000	2 - MTO	MVS32N4MD5A	129.984.000	2 - MTO
MVS40	4000	50	MVS40N3MD5A	168.525.000	2 - MTO	MVS40N4MD5A	207.170.000	2 - MTO

Catatan :

(1) Apabila arus < 20% In, harus ditambahkan external power supply AD module agar ammeter dapat berfungsi.

Air Circuit Breaker (ACB)

PPACB



EasyPact MVS



ET 2.0A/5.0A/6.0A

EasyPact™ MVS Tipe H Air Circuit Breaker 800 s/d 4000A65kA

EasyPact MVS H (65kA) + Electronic Trip 2.0A

- Arus nominal : 800A s/d 4000A.
- Kapasitas Pemutusan : **65 kA** pada 380/440V.
- Icu = Ics = Icw untuk 1sec.
- Built in thermal memory.
- Zone selective interlocking (ZSI) dengan 5.0A/6.0A
- Tidak ada derating sampai dengan 50°C.
- Trip unit Electronic Trip **2.0A**, memiliki setelan :
 - Long time protection (proteksi beban lebih) : **$I_r = 0.4 I_n$ s/d I_n** dengan 9 setelan.
 - Time delay untuk long time protection (**t_l**).
 - instantaneous protection (proteksi hubung singkat) : **$I_{sd} = 1.5 I_r$ s/d $10 I_r$** dengan 9 setelan.
- **ETA** Dilengkapi dengan **ammeter⁽¹⁾** untuk menampilkan besar arus tiap fase.
- 3 atau 4 kutub, fixed atau drawout type.
- Memenuhi standar IEC 60947-2.
- Dinilai penuh netral dengan perlindungan inbuilt

Spesifikasi standar

- Mekanisme pegas dengan sistem energi tersimpan.
- Horizontal rear connection.
- Auxiliary switches (4 changeover contact OF + SDE).
- Arc chute cover, **door frame**, dan safety shutter untuk drawout type.

	In (A)	Icu (kA)	3P			4P		
			Referensi	Harga (Rp) (Sebelum PPN)	SS	Referensi	Harga (Rp) (Sebelum PPN)	SS
Tipe Fixed								
MVS08	800	65	MVS08H3MF2A	39.510.000	2 - MTO	MVS08H4MF2A	48.525.000	2 - MTO
MVS10	1000	65	MVS10H3MF2A	42.426.000	2 - MTO	MVS10H4MF2A	52.021.000	2 - MTO
MVS12	1250	65	MVS12H3MF2A	45.853.000	1 - MTS	MVS12H4MF2A	53.479.000	1 - MTS
MVS16	1600	65	MVS16H3MF2A	52.550.000	1 - MTS	MVS16H4MF2A	64.349.000	1 - MTS
MVS20	2000	65	MVS20H3MF2A	57.671.000	1 - MTS	MVS20H4MF2A	67.879.000	1 - MTS
MVS25	2500	65	MVS25H3MF2A	74.522.000	1 - MTS	MVS25H4MF2A	88.283.000	1 - MTS
MVS32	3200	65	MVS32H3MF2A	85.069.000	1 - MTS	MVS32H4MF2A	104.267.000	1 - MTS
MVS40	4000	65	MVS40H3MF2A	147.338.000	2 - MTO	MVS40H4MF2A	176.318.000	2 - MTO
Tipe Drawout								
MVS08	800	65	MVS08H3MD2A	50.688.000	2 - MTO	MVS08H4MD2A	73.860.000	2 - MTO
MVS10	1000	65	MVS10H3MD2A	53.604.000	2 - MTO	MVS10H4MD2A	77.802.000	2 - MTO
MVS12	1250	65	MVS12H3MD2A	57.032.000	2 - MTO	MVS12H4MD2A	81.049.000	2 - MTO
MVS16	1600	65	MVS16H3MD2A	72.968.000	2 - MTO	MVS16H4MD2A	91.921.000	2 - MTO
MVS20	2000	65	MVS20H3MD2A	79.935.000	2 - MTO	MVS20H4MD2A	101.569.000	2 - MTO
MVS25	2500	65	MVS25H3MD2A	96.786.000	2 - MTO	MVS25H4MD2A	127.098.000	2 - MTO
MVS32	3200	65	MVS32H3MD2A	107.333.000	2 - MTO	MVS32H4MD2A	143.084.000	2 - MTO
MVS40	4000	65	MVS40H3MD2A	183.957.000	2 - MTO	MVS40H4MD2A	227.585.000	2 - MTO

Catatan :

(1) Apabila arus < 20% In, harus ditambahkan external power supply AD module agar ammeter dapat berfungsi.



EasyPact MVS



ET 2.0A/5.0A/6.0A

EasyPact MVS Tipe H

Air Circuit Breaker 800 s/d 4000A 65kA

EasyPact MVS H (65kA) + Electronic Trip 5.0A

- Arus nominal : 800A s/d 4000A.
- Kapasitas Pemutusan : **65 kA** pada 380/440V.
- Icu = Ics = Icw untuk 1sec.
- Built in thermal memory.
- Zone selective interlocking (ZSI) dengan 5.0A/6.0A/5.0V/6.0V.
- Tidak ada derating sampai dengan 50°C.
- Trip unit Electronic Trip **5.0A**, memiliki setelan :
 - long time protection (proteksi beban lebih) : **$I_r = 0.4 I_n$ s/d I_n** dengan 9 setelan.
 - time delay untuk long time protection (t_r).
 - instantaneous protection (proteksi hubung singkat) : **$I_{sd} = 1.5 I_r$ s/d $10 I_r$** dengan 9 setelan.
 - time delay untuk short time protection (t_{sd})
 - Instantaneous protection **$I_i = 2 I_n$ s/d $15 I_n + 'off'$** , dengan 9 setelan.
- **ETA** Dilengkapi dengan **ammeter⁽¹⁾** untuk menampilkan besar arus tiap fase.
- 3 atau 4 kutub, fixed atau drawout type.
- Memenuhi standar IEC 60947-2.
- Dinilai penuh netral dengan perlindungan inbuilt

Spesifikasi standar

- Mekanisme pegas dengan sistem energi tersimpan.
- Horizontal rear connection.
- Auxiliary switches (4 changeover contact OF + SDE).
- Arc chute cover, **door frame**, dan safety shutter untuk drawout type.

	In (A)	Icu (kA)	3P			4P		
			Referensi	Harga (Rp) (Sebelum PPN)	SS	Referensi	Harga (Rp) (Sebelum PPN)	SS
Type Fixed								
MVS08	800	65	MVS08H3MF5A	50.688.000	2 - MTO	MVS08H4MF5A	57.450.000	2 - MTO
MVS10	1000	65	MVS10H3MF5A	51.581.000	2 - MTO	MVS10H4MF5A	63.197.000	2 - MTO
MVS12	1250	65	MVS12H3MF5A	55.118.000	2 - MTO	MVS12H4MF5A	64.654.000	2 - MTO
MVS16	1600	65	MVS16H3MF5A	63.729.000	2 - MTO	MVS16H4MF5A	75.528.000	2 - MTO
MVS20	2000	65	MVS20H3MF5A	68.657.000	2 - MTO	MVS20H4MF5A	78.864.000	2 - MTO
MVS25	2500	65	MVS25H3MF5A	85.085.000	2 - MTO	MVS25H4MF5A	98.845.000	2 - MTO
MVS32	3200	65	MVS32H3MF5A	96.053.000	2 - MTO	MVS32H4MF5A	114.831.000	2 - MTO
MVS40	4000	65	MVS40H3MF5A	154.698.000	2 - MTO	MVS40H4MF5A	187.305.000	2 - MTO
Type Drawout								
MVS08	800	65	MVS08H3MD5A	58.690.000	2 - MTO	MVS08H4MD5A	84.335.000	2 - MTO
MVS10	1000	65	MVS10H3MD5A	61.606.000	2 - MTO	MVS10H4MD5A	88.116.000	2 - MTO
MVS12	1250	65	MVS12H3MD5A	65.034.000	2 - MTO	MVS12H4MD5A	88.561.000	2 - MTO
MVS16	1600	65	MVS16H3MD5A	84.145.000	2 - MTO	MVS16H4MD5A	101.679.000	2 - MTO
MVS20	2000	65	MVS20H3MD5A	87.937.000	2 - MTO	MVS20H4MD5A	107.422.000	2 - MTO
MVS25	2500	65	MVS25H3MD5A	108.086.000	2 - MTO	MVS25H4MD5A	132.951.000	2 - MTO
MVS32	3200	65	MVS32H3MD5A	114.039.000	2 - MTO	MVS32H4MD5A	154.198.000	2 - MTO
MVS40	4000	65	MVS40H3MD5A	191.959.000	2 - MTO	MVS40H4MD5A	239.265.000	2 - MTO

Catatan :

(1) Apabila arus < 20% In, harus ditambahkan external power supply AD module agar ammeter dapat berfungsi.

Air Circuit Breaker (ACB)

PPACB



EasyPact MVS



ET 2.0A/5.0A/6.0A

EasyPact MVS Tipe T

Air Circuit Breaker 2000 s/d 4000A 85kA

EasyPact MVS T (85kA) + Electronic Trip 2.0A/5.0A

- Arus nominal : 2000A s/d 4000A.
- Kapasitas Pemutusan : 85 kA pada 380/440V .
- Icu = Ics = Icw untuk 1sec
- dalam Dibangun Thermal memory
- Zone selective interlocking (ZSI) dengan 5.0A/6.0A
- Tidak ada derating sampai dengan 500C
- Trip unit Electronic Trip 2.0A/5.0A, memiliki setelan :
 - 2.0A/5.0A: long time protection (proteksi beban lebih) : $I_r = 0.4 I_n$ s/d I_n dengan 9 setelan.
 - 2.0A/5.0A: time delay untuk long time protection (tr).
 - 2.0A/5.0A: instantaneous protection (proteksi hubung singkat) : $I_{sd} = 1.5 I_r$ s/d $10 I_r$ dengan 9 setelan.
 - 5.0A: time delay untuk short time protection (tsd)
 - 5.0A: Instantaneous protection $I_i = 2 I_n$ s/d $15 I_n$ + 'off', dengan 9 setelan.
- ETA Dilengkapi dengan **ammeter**⁽¹⁾ untuk menampilkan besar arus tiap fase.
- 3 atau 4 pole, fixed atau drawout type.
- Memenuhi standar IEC 60947-2.
- Dinilai penuh netral dengan perlindungan inbuilt

Spesifikasi standar

- Mekanisme pegas dengan sistem energi tersimpan.
- Horizontal rear connection.
- Auxiliary switches (4 changeover contact OF + SDE).
- Arc chute cover dan safety shutter untuk drawout type.

3 Kutub

	In (A)	Icu (kA)	3P, Mic 2A			3P, Mic 5A		
			Referensi	Harga (Rp) (Sebelum PPN)	SS	Referensi	Harga (Rp) (Sebelum PPN)	SS
Tipe Fixed								
MVS20	2000	85	MVS20T3NF2A	63.438.000	2 - MTO	MVS20T3NF5A	75.522.000	2 - MTO
MVS25	2500	85	MVS25T3NF2A	81.975.000	2 - MTO	MVS25T3NF5A	93.593.000	2 - MTO
MVS32	3200	85	MVS32T3NF2A	93.576.000	2 - MTO	MVS32T3NF5A	105.659.000	2 - MTO
MVS40	4000	85	MVS40T3NF2A	162.072.000	2 - MTO	MVS40T3NF5A	62.509.000	2 - MTO
Tipe Drawout								
MVS20	2000	85	MVS20T3NW2A	87.929.000	2 - MTO	MVS20T3NW5A	81.132.000	2 - MTO
MVS25	2500	85	MVS25T3NW2A	106.465.000	2 - MTO	MVS25T3NW5A	118.894.000	2 - MTO
MVS32	3200	85	MVS32T3NW2A	118.066.000	2 - MTO	MVS32T3NW5A	126.360.000	2 - MTO
MVS40	4000	85	MVS40T3NW2A	202.353.000	2 - MTO	MVS40T3NW5A	101.722.000	2 - MTO

4 Kutub

	In (A)	Icu (kA)	4P, Mic 2A			4P, Mic 5A		
			Referensi	Harga (Rp) (Sebelum PPN)	SS	Referensi	Harga (Rp) (Sebelum PPN)	SS
Tipe Fixed								
MVS20	2000	85	MVS20T4NF2A	75.438.000	2 - MTO	MVS20T4NF5A	87.522.000	2 - MTO
MVS25	2500	85	MVS25T4NF2A	93.975.000	2 - MTO	MVS25T4NF5A	105.593.000	2 - MTO
MVS32	3200	85	MVS42T4NF2A	105.576.000	2 - MTO	MVS42T4NF5A	117.659.000	2 - MTO
MVS40	4000	85	MVS40T4NF2A	174.072.000	2 - MTO	MVS40T4NF5A	74.509.000	2 - MTO
Tipe Drawout								
MVS20	2000	85	MVS20T4NW2A	107.929.000	2 - MTO	MVS20T4NW5A	101.132.000	2 - MTO
MVS25	2500	85	MVS25T4NW2A	126.465.000	2 - MTO	MVS25T4NW5A	138.894.000	2 - MTO
MVS32	3200	85	MVS42T4NW2A	138.066.000	2 - MTO	MVS42T4NW5A	146.360.000	2 - MTO
MVS40	4000	85	MVS40T4NW2A	222.353.000	2 - MTO	MVS40T4NW5A	121.722.000	2 - MTO

■ Indication Contacts



OF



EF



SDE



CE, CD, CT

Auxiliaries	Fixed	Harga (Rp) (Sebelum PPN)	SS	Drawout	Harga (Rp) (Sebelum PPN)	SS
ON/OFF Indication Contacts (OF)						
Bekerja jika jarak isolasi minimum antara main contact tercapai.						
Block of 4 changeover contacts 6A - 240V	1 block (standar)			1 block (standar)		
1 additional block of 4 contacts (2 max)	48198	3.214.000	1 - MTS	48468	3.214.000	1 - MTS
Combined Closed / Connected Contact (EF)						
Memberikan informasi bahwa breaker dalam posisi "connected" dan "closed". Dipasang dengan 1 OF contact tambahan.						
1 contact (8 max) 5A - 240V				48477	867.000	2 - MTO
"Fault Trip" Indication Contacts (SDE)						
Indikasi circuit breaker trip karena adanya gangguan.						
Changeover contact 5A - 240V	1 (standar)			1 (standar)		
1 additional SDE 5A - 240V	48200	950.000	2 - MTO	48475	950.000	2 - MTO
Auxiliary Terminal Untuk Chassis						
6 wire terminal (10 parts)				47899	6.148.000	2 - MTO
Carriage Switches (Connected / Disconnected / Test Position)						
Menunjukkan posisi circuit breaker : connected, test atau disconnected.						
1 connected position contact CE (3 max)				33751	715.000	2 - MTO
1 test position contact CT (1 max)				33752	715.000	2 - MTO
1 disconnected position contact CD (2 max)				33753	715.000	2 - MTO

■ Remote ON/OFF

Fungsi remote ON/OFF digunakan untuk membuka dan menutup breaker dari jarak jauh, terdiri dari :

- 1 Gear motor (MCH) : Untuk pengoperasian secara elektrik, mengisi spring mechanism secara otomatis saat breaker tertutup sehingga memungkinkan instantaneous reclosing ketika breaker terbuka.
- 2 Voltage release :
 - 1 Closing release (XF) : Menutup breaker dari jarak jauh jika spring mechanism discharge.
 - 1 Opening release (MX) : Membuka breaker bila diberi tegangan supply (0.7 - 1.1 Un).

Sebagai pilihan, dapat ditambahkan fungsi :

- "Ready to close" contact : Mengecek keadaan breaker, sebelum pemutusan secara manual/elektrik.
- Electrical closing pushbutton : Menutup breaker secara elektrik.
- Remote reset following a fault : Mereset SDE dan tombol reset, setelah breaker trip.

Biasanya dilengkapi dengan :

- ON/OFF indication contact (OF).
- "Fault trip" indication contact (SDE).



MCH



XF / MX



BPFE



MX / MN

Auxiliaries	Fixed	Harga (Rp) (Sebelum PPN)	SS	Drawout	Harga (Rp) (Sebelum PPN)	SS
Gear Motor (MCH)						
Gear Motor (MCH) 200-240 V AC ⁽¹⁾	48212	14.347.000	1 - MTS	48527	14.320.000	1 - MTS
Instantaneous Voltage Releases						
Closing Release (XF) Standar 200-250 V AC/DC ⁽¹⁾	47353	2.546.000	1 - MTS	48484	2.542.000	1 - MTS
Communicating 200-250 V AC/DC ⁽¹⁾	47314	2.542.000	2 - MTO	48452	2.615.000	2 - MTO
Opening release (MX) Standar 200-250 V AC/DC ⁽¹⁾	47363	2.546.000	1 - MTS	48494	2.542.000	1 - MTS
Communicating 200-250 V AC/DC ⁽¹⁾	47324	2.618.000	2 - MTO	48461	2.618.000	2 - MTO
"Ready To Close" Contact (PF)						
1 Changeover Contact (5 A - 240 V)	47342	1.512.000	2 - MTO	48469	1.510.000	1 - MTS
Electrical Closing Pushbutton (BPFE)						
1 Pushbutton	48534	1.789.000	2 - MTO	48534	1.789.000	2 - MTO
Remote Reset After Fault Trip						
Electrical Reset (Res) 200-240 V AC ⁽¹⁾	48203	4.111.000	2 - MTO	48473	4.111.000	2 - MTO

■ Remote Tripping

Fungsi remote tripping digunakan untuk membuka breaker secara elektrik, terdiri dari :

- 1 Shunt Release (MX).
- atau 1 Under Voltage Release (MN) : membuka breaker jika tegangan supply berada antara 35% sampai 70% Un.
- atau 1 Delayed Under Voltage Release (MN + delay unit).

Auxiliaries	Fixed	Harga (Rp) (Sebelum PPN)	SS	Drawout	Harga (Rp) (Sebelum PPN)	SS
Instantaneous Voltage Release						
Shunt Release (2nd MX) 200-250 V AC/DC ⁽¹⁾	47373	2.675.000	1 - MTS	48514	2.756.000	2 - MTO
Under Voltage Release (MN) 200-250 V AC/DC ⁽¹⁾	47383	3.452.000	1 - MTS	48504	3.452.000	1 - MTS
MN delay unit						
Unit tunda waktu untuk Under Voltage Release.						
Non-adjustable (R) 200-250 V AC/DC ⁽¹⁾	33685	4.757.000	2 - MTO	33685	4.757.000	2 - MTO
Adjustable (Rr) 200-250 V AC/DC ⁽¹⁾	33682	3.818.000	2 - MTO	33682	3.818.000	2 - MTO

Catatan :

(1) Untuk tegangan kontrol lainnya, silakan hubungi kami.

■ Pedomian Pilihan

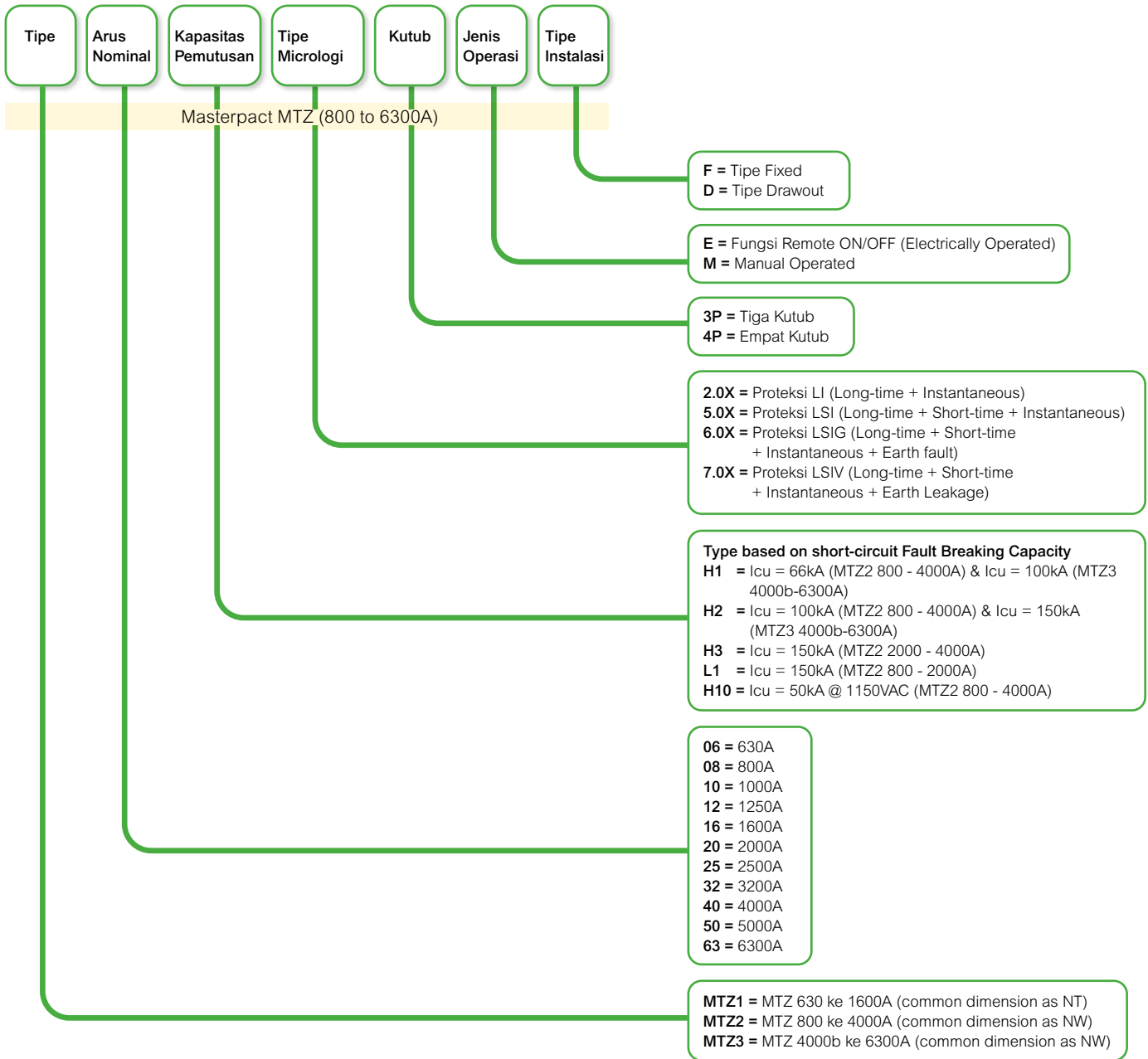

Contoh 1 : MTZ232H12.0X4PED

MTZ2	32	H1	2.0X	4P	E	D
Masterpact MTZ 2	3200A	66kA	Micrologic 2.0X	Empat Kutub	Fungsi Remote ON/OFF	Tipe Drawout

Contoh 2 : MTZ350H25.0X3PMF

MTZ3	50	H2	5.0X	3P	M	F
Masterpact MTZ 3	5000A	100KA	Micrologic 5.0X	Tiga Kutub	Manual Operated	Tipe Fixed

Catatan :

- Masterpact MTZ dengan Electrical version, termasuk Motor mechanism + XF (Closing release) + MX (Opening release)
- ULP Port pada Masterpact MTZ drawout sudah termasuk, sedangkan ULP Port pada tipe MTZ tipe fixed harus dibeli terpisah jika dibutuhkan

MasterPact™ MTZ Circuit Breakers: A new digital user experience

Design



EcoStruxure Power

Design software
Single-line diagram design software that calculates and sizes your electrical installation.

EcoStruxure Power

Build software
Quick configuration and quotation tool for switchboards.

Configure And Order



Product Selector

Configure MasterPact MTZ to save time and ensure accuracy.

MySE

Order your MasterPact MTZ online

Build And Commission



EcoStruxure Power Commission software

Commission and upgrade easily with protection setting and factory-acceptance test.

Monitor with EcoStruxure Power software

Obtain data visualization and reporting for increased efficiency.

Operate And Maintain



EcoStruxure Power monitoring software

- EcoStruxure Power Monitoring Expert
- EcoStruxure Power SCADA Operation
- EcoStruxure Building Operation
- EcoStruxure Facility Advisor

schneider-electric.com/ecostruxure-facility-advisor

Remote, continuous notifications

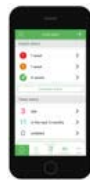

The EcoStruxure Facility Expert maintenance logbook app. Track facility data and receive alerts in case of power events and scheduled maintenance.

schneider-electric.com/ecostruxure-facility-expert

Operate with MicroLogic X control unit



Locally in the facility room
Status "at a glance"



Operate with your smartphone



Locally in the facility room



Ecostruxure Power Device App

Android



iOS



Customize Or Upgrade



GoDigital store

Purchase additional digital modules for even more visibility and efficiency over the MasterPact MTZ circuit breaker life cycle.

godigital.schneider-electric.com

Advanced functions

Downloadable digital modules for advanced functions from GoDigital Store:

- Protection
- Measurement
- Diagnostics and maintenance

MasterPact™ MTZ Micrologic Trip Unit



■ Protection

Dual Settings and additional facilities increase the performance and the flexibility of low voltage systems of protection.

■ Diagnostics & Maintenance

Micrologic X integrates new extended diagnostics and assistance to Maintenance.

■ 10 Digital Modules

Optional 24/7 downloadable digital module to upgrade Micrologic X.
Anytime, Anywhere!

■ Communication

- Ethernet TCP / IP
- *Wireless* communication: NFC / Bluetooth

■ Measurement

Micrologic X offers all measuring functions of a Power Meter including Energy Class 1 accuracy (including CT - current sensors) third-party certified.



Harga Micrologic trip unit di bawah ini adalah harga penambahan pada Masterpact MTZ dengan trip unit Micrologic 2.0X ([lihat halaman 7-19](#))

Micrologic 2.0X - LI: Long-time + Instantaneous

Micrologic 5.0X - LSI: Long-time + Short-time + Instantaneous

Micrologic 6.0X - LSIG: Long-time + Short-time + Instantaneous + Earth fault

Micrologic 7.0X - LSIV: Long-time + Short-time + Instantaneous + Earth Leakage



Micrologic X trip unit harus dipesan dengan circuit breaker yang diperlukan dan dirakit oleh PT Schneider Indonesia.

Customize your Micrologic X anytime!

Digital Modules make it easy to upgrade & customized your system



Protection



Measurement



Diagnostic & Maintenance

Air Circuit Breaker (ACB)

PPACB



Masterpact MTZ2



Masterpact MTZ3



Micrologic 2.0X Digital Module
MTZ App Handphone

MasterPact™ MTZ 2/3 Air Circuit Breaker 800 s/d 6300A

Masterpact MTZ2/3 Tipe H1 + Micrologic 2.0X Manually Operated

- Arus nominal : 800A s/d 6300A.
- Kapasitas Pemutusan : 66 kA s/d 100 kA pada 380/440V.
- Icu = Ics = Icw_(1sec) = 66kA (800-4000A) dan 100kA (5000-6300A).
- Full Discriminated sampai downstream breaker Kapasitas Pemutusan (grafik tersedia).
- Upgrade Anytime, Anywhere dengan MTZ Digital Modules ([halaman 7-22](#)).
- Zone selective interlocking (ZSI) dengan 2.0X/5.0X/6.0X
- Trip unit **Micrologic 2.0X**, memiliki 3 setelan :
 - long time protection (proteksi beban lebih) : **Ir = 0.4 In** s/d In dengan 9 setelan.
 - time delay untuk long time protection (t_l).
 - instantaneous protection (proteksi hubung singkat) : **Isd = 1.5 Ir** s/d **10 Ir** dengan 9 setelan.
- Dual settings functions
- Class 1 embedded Metering: current, voltage, active/reactive/apparent Power & Energy, power Factor, Frequency, Unbalance dan THD voltage & current
- 3 atau 4 pole, fixed atau drawout type
- Memenuhi standar IEC 60947-2.
- Rating netral penuh dengan perlindungan built in



- Untuk pemesanan, silakan gunakan product code pada Product Selector.
- Masterpact dan kelengkapannya hanya dapat dirakit oleh PT Schneider Indonesia.

Spesifikasi standar

- Digital Module (Software App) - Energy per Phase
- Mekanisme pegas dengan sistem energi tersimpan.
- Horizontal rear connection (800-5000A) dan Vertikal rear connection (6300A)
- Auxiliary switches (4 changeover contact OF + SDE).
- Arc chute cover dan safety shutter untuk drawout type.
- CD&CE&CT Position Contacts untuk Drawout Type tanpa EIFE

	In (A)	Icu (kA)	3P	Product Code	Harga (Rp) (Sebelum PPN)	SS	4P	Product Code	Harga (Rp) (Sebelum PPN)	SS
Tipe Manual Fixed										
MTZ08	800	66	MTZ208H12.0X3PMF	WACFAAANN**ANNNNNNNN	48.066.000		MTZ208H12.0X4PMF	WACFABANN**ANNNNNNNN	58.391.000	
MTZ10	1000	66	MTZ210H12.0X3PMF	WADGAAANN**ANNNNNNNN	51.598.000		MTZ210H12.0X4PMF	WADGABANN**ANNNNNNNN	62.579.000	
MTZ12	1250	66	MTZ212H12.0X3PMF	WAEIAAANN**ANNNNNNNN	52.611.000		MTZ212H12.0X4PMF	WAEIABANN**ANNNNNNNN	64.326.000	
MTZ16	1600	66	MTZ216H12.0X3PMF	WAFJAAANN**ANNNNNNNN	61.983.000		MTZ216H12.0X4PMF	WAFJABANN**ANNNNNNNN	77.354.000	
MTZ20	2000	66	MTZ220H12.0X3PMF	WAGKAAANN**ANNNNNNNN	70.556.000	2 - MTO	MTZ220H12.0X4PMF	WAGKABANN**ANNNNNNNN	92.195.000	2 - MTO
MTZ25	2500	66	MTZ225H12.0X3PMF	WAHLAAANN**ANNNNNNNN	91.098.000		MTZ225H12.0X4PMF	WAHLABANN**ANNNNNNNN	107.872.000	
MTZ32	3200	66	MTZ232H12.0X3PMF	WAIPAAANN**ANNNNNNNN	100.739.000		MTZ232H12.0X4PMF	WAIPABANN**ANNNNNNNN	127.369.000	
MTZ40	4000	66	MTZ240H12.0X3PMF	WAJRAAANN**ANNNNNNNN	179.865.000		MTZ240H12.0X4PMF	WAJRABANN**ANNNNNNNN	215.194.000	
MTZ50	5000	100	MTZ350H12.0X3PMF	YAKSAAANN**ANNNNNNNN	261.796.000		MTZ350H12.0X4PMF	YAKSABANN**ANNNNNNNN	323.911.000	
MTZ63	6300	100	MTZ363H12.0X3PMF	YALUAAENN**ANNNNNNNN	356.411.000		MTZ363H12.0X4PMF	YALUABENN**ANNNNNNNN	373.136.000	
Tipe Manual Drawout										
MTZ08	800	66	MTZ208H12.0X3PMD	WACFADAAN**ANNNNNNNN	70.354.000		MTZ208H12.0X4PMD	WACFAEAAAN**ANNNNNNNN	87.971.000	
MTZ10	1000	66	MTZ210H12.0X3PMD	WADGADAAN**ANNNNNNNN	73.885.000		MTZ210H12.0X4PMD	WADGAEAAAN**ANNNNNNNN	92.160.000	
MTZ12	1250	66	MTZ212H12.0X3PMD	WAEIADAAN**ANNNNNNNN	74.899.000		MTZ212H12.0X4PMD	WAEIEAAAN**ANNNNNNNN	93.905.000	
MTZ16	1600	66	MTZ216H12.0X3PMD	WAFJADAAN**ANNNNNNNN	84.271.000		MTZ216H12.0X4PMD	WAFJAEAAAN**ANNNNNNNN	106.934.000	
MTZ20	2000	66	MTZ220H12.0X3PMD	WAGKADAAN**ANNNNNNNN	95.669.000	2 - MTO	MTZ220H12.0X4PMD	WAGKAEAAAN**ANNNNNNNN	120.880.000	2 - MTO
MTZ25	2500	66	MTZ225H12.0X3PMD	WAHLADAAN**ANNNNNNNN	117.850.000		MTZ225H12.0X4PMD	WAHLAEAAAN**ANNNNNNNN	145.707.000	
MTZ32	3200	66	MTZ232H12.0X3PMD	WAIPADAAN**ANNNNNNNN	135.337.000		MTZ232H12.0X4PMD	WAIPAEAAAN**ANNNNNNNN	179.950.000	
MTZ40	4000	66	MTZ240H12.0X3PMD	WAJRADAAN**ANNNNNNNN	223.490.000		MTZ240H12.0X4PMD	WAJRAEAAAN**ANNNNNNNN	275.441.000	
MTZ50	5000	100	MTZ350H12.0X3PMD	YAKSADAAN**ANNNNNNNN	358.235.000		MTZ350H12.0X4PMD	YAKSAEAAAN**ANNNNNNNN	462.305.000	
MTZ63	6300	100	MTZ363H12.0X3PMD	YALUADENN**ANNNNNNNN	452.850.000		MTZ363H12.0X4PMD	YALUAEENN**ANNNNNNNN	511.531.000	

Catatan :

- Apabila arus < 20% In, harus ditambahkan external power supply AD module atau VPS (Voltage Power Supply Module) atau Mobile Power Pack agar metering dapat berfungsi.
- Hanya dapat ditampilkan di Micrologic display atau MTZ App di Hand Phone atau di FDM121 Display module.
- Masterpact MTZ3 6300A hanya tersedia dengan vertical rear connection.
- Untuk harga Masterpact MTZ dengan Trip Unit Micrologic lainnya, silakan [lihat halaman 7-19](#)
- Referensi untuk ACB MTZ2 2500A H2 4 Pole D/O Mic 2.0X Koneksi Horizontal terdapat pada buku Price List yaitu MTZ225H22.0X4PED, jika menginginkan koneksi vertikal silakan gunakan konfigurasi Product Selector
- Pada **MTZ tipe Fixed ULP Port harus dibeli terpisah** karena belum termasuk dalam konfigurasi di atas
- Untuk harga Masterpact MTZ dengan modul Komunikasi, silakan [lihat halaman 7-21](#)

Air Circuit Breaker (ACB)

PPACB



Micrologic 2.0X Digital Module MTZ App Handphone



Untuk pemesanan, silakan gunakan product code pada Product Selector.
Masterpact dan kelengkapannya hanya dapat dirakit oleh PT Schneider Indonesia.

MasterPact™ MTZ 2/3

Air Circuit Breaker 800 s/d 6300A

Masterpact MTZ2/3 Tipe H1 + Micrologic 2.0X Electrically Operated

- Arus nominal : 800A s/d 6300A.
- Kapasitas Pemutusan : 66 kA s/d 100 kA pada 380/440V.
- ICU = Ics = Icw_(1sec) = 66kA (800-4000A) dan 100kA (5000-6300A).
- Full Discriminated sampai downstream breaker Kapasitas Pemutusan (grafik tersedia)
- Upgrade Anytime, Anywhere dengan MTZ Digital Modules ([halaman 7-22](#)).
- Zone selective interlocking (ZSI) dengan 2.0X/5.0X/6.0X
- Trip unit **Micrologic 2.0X**, memiliki 3 setelan :
 - long time protection (proteksi beban lebih) : **Ir = 0.4 In s/d In** dengan 9 setelan.
 - time delay untuk long time protection (t_l).
 - instantaneous protection (proteksi hubung singkat) : **I_{sd} = 1.5 Ir s/d 10 Ir** dengan 9 setelan.
- Dual settings functions
- Class 1 embedded Metering: current, voltage, active/reactive/apparent Power & Energy, Power Factor, Frequency, Unbalance dan THD voltage & current
- 3 atau 4 pole, fixed atau drawout type
- Memenuhi standar IEC 60947-2.
- Rating netral penuh dengan perlindungan built in

Spesifikasi standar

- Digital Module (Software App) - Energy per Phase
- Gear Motor (MCH) 200-240VAC + Closing Release (XF) 200-240VAC + Opening Release (MX) 200-240VAC
- Mekanisme pegas dengan sistem energi tersimpan.
- Horizontal rear connection (800-5000A) dan Vertikal rear connection (6300A)
- Auxiliary switches (4 changeover contact OF + SDE).
- Arc chute cover dan safety shutter untuk drawout type.
- CD&CE&CT Position Contacts untuk Drawout Type tanpa EIFE

	In (A)	Icu (kA)	3P Referensi	Product Code	Harga (Rp) (Sebelum PPN)	SS	4P Referensi	Product Code	Harga (Rp) (Sebelum PPN)	SS
Tipe Electrical Fixed										
MTZ08	800	66	MTZ208H12.0X3PEF	WACFAAANNNNNNNNNN-CEENNN*ANNNNNNN	67.512.000		MTZ208H12.0X4PEF	WACFABANNNNNNNNNN-CEENNN*ANNNNNNN	77.837.000	
MTZ10	1000	66	MTZ210H12.0X3PEF	WADGAAANNNNNNNNNN-CEENNN*ANNNNNNN	71.044.000		MTZ210H12.0X4PEF	WADGABANNNNNNNNNN-CEENNN*ANNNNNNN	82.025.000	
MTZ12	1250	66	MTZ212H12.0X3PEF	WAEIAAANNNNNNNNNN-CEENNN*ANNNNNNN	72.057.000		MTZ212H12.0X4PEF	WAEIABANNNNNNNNNN-CEENNN*ANNNNNNN	83.771.000	
MTZ16	1600	66	MTZ216H12.0X3PEF	WAFJAAANNNNNNNNNN-CEENNN*ANNNNNNN	81.429.000		MTZ216H12.0X4PEF	WAFJABANNNNNNNNNN-CEENNN*ANNNNNNN	96.800.000	
MTZ20	2000	66	MTZ220H12.0X3PEF	WAGKAAANNNNNNNNNN-CEENNN*ANNNNNNN	90.003.000	2 - MTO	MTZ220H12.0X4PEF	WAGKABANNNNNNNNNN-CEENNN*ANNNNNNN	111.641.000	2 - MTO
MTZ25	2500	66	MTZ225H12.0X3PEF	WAHLAAANNNNNNNNNN-CEENNN*ANNNNNNN	110.544.000		MTZ225H12.0X4PEF	WAHLABANNNNNNNNNN-CEENNN*ANNNNNNN	127.318.000	
MTZ32	3200	66	MTZ232H12.0X3PEF	WAIPAAANNNNNNNNNN-CEENNN*ANNNNNNN	120.185.000		MTZ232H12.0X4PEF	WAIPABANNNNNNNNNN-CEENNN*ANNNNNNN	146.815.000	
MTZ40	4000	66	MTZ240H12.0X3PEF	WAJRAAANNNNNNNNNN-CEENNN*ANNNNNNN	199.311.000		MTZ240H12.0X4PEF	WAJRABANNNNNNNNNN-CEENNN*ANNNNNNN	234.640.000	
MTZ50	5000	100	MTZ350H12.0X3PEF	YAKSAAANNNNNNNNNN-CEENNN*ANNNNNNN	281.241.000		MTZ350H12.0X4PEF	YAKSABANNNNNNNNNN-CEENNN*ANNNNNNN	343.358.000	
MTZ63	6300	100	MTZ363H12.0X3PEF	YALUAAENNNNNNNNNN-CEENNN*ANNNNNNN	375.856.000		MTZ363H12.0X4PEF	YALUABANNNNNNNNNN-CEENNN*ANN	392.582.000	
Tipe Electrical Drawout										
MTZ08	800	66	MTZ208H12.0X3PED	WACFADAANNNNNNNNN-CEENNN*ANNNNNNN	89.800.000		MTZ208H12.0X4PED	WACFAEAANNNNNNNNN-CEENNN*ANNNNNNN	107.418.000	
MTZ10	1000	66	MTZ210H12.0X3PED	WADGADAANNNNNNNNN-CEENNN*ANNNNNNN	93.331.000		MTZ210H12.0X4PED	WADGAEAANNNNNNNNN-CEENNN*ANNNNNNN	111.606.000	
MTZ12	1250	66	MTZ212H12.0X3PED	WAEIADAANNNNNNNNN-CEENNN*ANNNNNNN	94.345.000		MTZ212H12.0X4PED	WAEIAEAANNNNNNNNN-CEENNN*ANNNNNNN	113.351.000	
MTZ16	1600	66	MTZ216H12.0X3PED	WAFJADAANNNNNNNNN-CEENNN*ANNNNNNN	103.717.000		MTZ216H12.0X4PED	WAFJAEAANNNNNNNNN-CEENNN*ANNNNNNN	126.380.000	
MTZ20	2000	66	MTZ220H12.0X3PED	WAGKADAANNNNNNNNN-CEENNN*ANNNNNNN	115.115.000	2 - MTO	MTZ220H12.0X4PED	WAGKAEAANNNNNNNNN-CEENNN*ANNNNNNN	140.326.000	2 - MTO
MTZ25	2500	66	MTZ225H12.0X3PED	WAHLADAANNNNNNNNN-CEENNN*ANNNNNNN	137.296.000		MTZ225H12.0X4PED	WAHLAEAANNNNNNNNN-CEENNN*ANNNNNNN	165.152.000	
MTZ32	3200	66	MTZ232H12.0X3PED	WAIPADAANNNNNNNNN-CEENNN*ANNNNNNN	154.783.000		MTZ232H12.0X4PED	WAIPAEAANNNNNNNNN-CEENNN*ANNNNNNN	199.396.000	
MTZ40	4000	66	MTZ240H12.0X3PED	WAJRADAANNNNNNNNN-CEENNN*ANNNNNNN	242.936.000		MTZ240H12.0X4PED	WAJRAEAANNNNNNNNN-CEENNN*ANNNNNNN	294.887.000	
MTZ50	5000	100	MTZ350H12.0X3PED	YAKSADAANNNNNNNNN-CEENNN*ANNNNNNN	377.681.000		MTZ350H12.0X4PED	YAKSAEAANNNNNNNNN-CEENNN*ANNNNNNN	481.751.000	
MTZ63	6300	100	MTZ363H12.0X3PED	YALUADEANNNNNNNNN-CEENNN*ANNNNNNN	472.296.000		MTZ363H12.0X4PED	YALUAEEANNNNNNNNN-CEENNN*ANNNNNNN	530.977.000	

Catatan :

- Apabila arus < 20% In, harus ditambahkan external power supply AD module atau VPS (Voltage Power Supply Module) atau Mobile Power Pack agar metering dapat berfungsi.
- Hanya dapat ditampilkan di Micrologic display atau MTZ App di Hand Phone atau di FDM121 Display module.
- Masterpact MTZ3 6300A hanya tersedia dengan vertical rear connection.
- Untuk harga Masterpact MTZ dengan Trip Unit Micrologic lainnya, silakan [lihat halaman 7-19](#)
- Referensi untuk ACB MTZ2 2500A H2 4 Pole D/O Mic 2.0X Koneksi Horizontal terdapat pada buku Price List yaitu MTZ225H22.0X4PED, jika menginginkan koneksi vertikal silakan gunakan konfigurasi Product Selector
- Pada **MTZ tipe Fixed ULP Port harus dibeli terpisah** karena belum termasuk dalam konfigurasi di atas
- Untuk harga Masterpact MTZ dengan modul Komunikasi, silakan [lihat halaman 7-21](#)

Air Circuit Breaker (ACB)

PPACB



Masterpact MTZ2



Masterpact MTZ3



Micrologic 2.0X Digital Module
MTZ App Handphone



- Untuk pemesanan, silakan gunakan product code pada Product Selector.
- Masterpact dan kelengkapannya hanya dapat dirakit oleh PT Schneider Indonesia.

MasterPact™ MTZ 2/3

Air Circuit Breaker 800 s/d 6300A

Masterpact MTZ2/3 Tipe H2 + Micrologic 2.0X Manually Operated

- Arus nominal : 800A s/d 6300A.
- Kapasitas Pemutusan : 66 kA s/d 100 kA pada 380/440V.
- Icu = Ics = 100kA, Icw_(1sec) = 85kA (800-4000A)
- Icu = Ics = 150kA, Icw_(1sec) = 100kA (5000-6300A)
- Full Discriminated sampai downstream breaker Kapasitas Pemutusan (grafik tersedia)
- Upgrade Anytime, Anywhere dengan MTZ Digital Modules ([halaman 7-22](#))
- Zone selective interlocking (ZSI) dengan 2.0X/5.0X/6.0X
- Trip unit **Micrologic 2.0X**, memiliki 3 setelan :
 - long time protection (proteksi beban lebih) : **Ir = 0.4 In s/d In** dengan 9 setelan.
 - time delay untuk long time protection (**t**).
 - instantaneous protection (proteksi hubung singkat) : **I_{sd} = 1.5 Ir s/d 10 Ir** dengan 9 setelan.
- Dual settings functions
- Class 1 embedded Metering: current, voltage, active/reactive/apparent Power & Energy, power Factor, Frequency, Unbalance dan THD voltage & current
- 3 atau 4 pole, fixed atau drawout type
- Memenuhi standar IEC 60947-2.
- Rating netral penuh dengan perlindungan built in

Spesifikasi standar

- Digital Module (Software App) - Energy per Phase
- Mekanisme pegas dengan sistem energi tersimpan.
- Horizontal rear connection (800-5000A) dan Vertikal rear connection (6300A)
- Auxiliary switches (4 changeover contact OF + SDE).
- Arc chute cover dan safety shutter untuk drawout type.
- CD&CE&CT Position Contacts untuk Drawout Type tanpa EIFE

	In (A)	Icu (kA)	3P Referensi	Product Code	Harga (Rp) (Sebelum PPN)	SS	4P Referensi	Product Code	Harga (Rp) (Sebelum PPN)	SS
Tipe Manual Fixed										
MTZ08	800	100	MTZ208H22.0X3PMF	WECFAAANN**ANNNNNNN	60.060.000		MTZ208H22.0X4PMF	WECFABANN**ANNNNNNN	72.539.000	
MTZ10	1000	100	MTZ210H22.0X3PMF	WEDGAAANN**ANNNNNNN	64.898.000		MTZ210H22.0X4PMF	WEDGABANN**ANNNNNNN	79.625.000	
MTZ12	1250	100	MTZ212H22.0X3PMF	WEEIAAANN**ANNNNNNN	66.290.000		MTZ212H22.0X4PMF	WEEIABANN**ANNNNNNN	82.016.000	
MTZ16	1600	100	MTZ216H22.0X3PMF	WEFJAAANN**ANNNNNNN	80.116.000		MTZ216H22.0X4PMF	WEFJABANN**ANNNNNNN	99.864.000	
MTZ20	2000	100	MTZ220H22.0X3PMF	WEGKAAANN**ANNNNNNN	87.976.000	2 - MTO	MTZ220H22.0X4PMF	WEGKABANN**ANNNNNNN	109.172.000	2 - MTO
MTZ25	2500	100	MTZ225H22.0X3PMF	WEHLAAANN**ANNNNNNN	121.662.000		MTZ225H22.0X4PMF	WEHLABANN**ANNNNNNN	137.236.000	
MTZ32	3200	100	MTZ232H22.0X3PMF	WEIPAAANN**ANNNNNNN	134.385.000		MTZ232H22.0X4PMF	WEIPABANN**ANNNNNNN	165.617.000	
MTZ40	4000	100	MTZ240H22.0X3PMF	WEJRAAANN**ANNNNNNN	235.753.000		MTZ240H22.0X4PMF	WEJRABANN**ANNNNNNN	265.236.000	
MTZ50	5000	150	MTZ350H22.0X3PMF	YEKSAAANN**ANNNNNNN	405.605.000		MTZ350H22.0X4PMF	YEKSABANN**ANNNNNNN	416.148.000	
MTZ63	6300	150	MTZ363H22.0X3PMF	YELUAAENN**ANNNNNNN	521.475.000		MTZ363H22.0X4PMF	YELUABENN**ANNNNNNN	574.104.000	
Tipe Manual Drawout										
MTZ08	800	100	MTZ208H22.0X3PMD	WECFADAAN**ANNNNNNN	85.172.000		MTZ208H22.0X4PMD	WECFAEAAN**ANNNNNNN	101.223.000	
MTZ10	1000	100	MTZ210H22.0X3PMD	WEDGADAAN**ANNNNNNN	90.009.000		MTZ210H22.0X4PMD	WEDGAEAAAN**ANNNNNNN	108.309.000	
MTZ12	1250	100	MTZ212H22.0X3PMD	WEEIADAAN**ANNNNNNN	91.402.000		MTZ212H22.0X4PMD	WEEIAEAAN**ANNNNNNN	110.700.000	
MTZ16	1600	100	MTZ216H22.0X3PMD	WEFJADAAN**ANNNNNNN	105.228.000		MTZ216H22.0X4PMD	WEFJAEAAAN**ANNNNNNN	128.548.000	
MTZ20	2000	100	MTZ220H22.0X3PMD	WEGKADAAN**ANNNNNNN	113.088.000	2 - MTO	MTZ220H22.0X4PMD	WEGKAEAAAN**ANNNNNNN	137.856.000	2 - MTO
MTZ25	2500	100	MTZ225H22.0X3PMD	WEHLADAAN**ANNNNNNN	148.415.000		MTZ225H22.0X4PMD	WEHLAEAAAN**ANNNNNNN	175.070.000	
MTZ32	3200	100	MTZ232H22.0X3PMD	WEIPADAAN**ANNNNNNN	168.983.000		MTZ232H22.0X4PMD	WEIPAEAAAN**ANNNNNNN	218.198.000	
MTZ40	4000	100	MTZ240H22.0X3PMD	WEJRADAAN**ANNNNNNN	279.378.000		MTZ240H22.0X4PMD	WEJRAEAAN**ANNNNNNN	325.483.000	
MTZ50	5000	150	MTZ350H22.0X3PMD	YEKSADAAN**ANNNNNNN	502.044.000		MTZ350H22.0X4PMD	YEKSAEAAN**ANNNNNNN	554.543.000	
MTZ63	6300	150	MTZ363H22.0X3PMD	YELUADENN**ANNNNNNN	617.914.000		MTZ363H22.0X4PMD	YELUAEENN**ANNNNNNN	712.499.000	

Catatan :

- Apabila arus < 20% In, harus ditambahkan external power supply AD module atau VPS (Voltage Power Supply Module) atau Mobile Power Pack agar metering dapat berfungsi.
- Hanya dapat ditampilkan di Micrologic display atau MTZ App di Hand Phone atau di FDM121 Display module.
- Masterpact MTZ3 6300A hanya tersedia dengan vertical rear connection.
- Untuk harga Masterpact MTZ dengan Trip Unit Micrologic lainnya, silakan [lihat halaman 7-19](#)

- Referensi untuk ACB MTZ2 2500A H2 4 Pole D/O Mic 2.0X Koneksi Horizontal terdapat pada buku Price List yaitu MTZ225H22.0X4PED, jika menginginkan koneksi vertikal silakan gunakan konfigurasi Product Selector
- Pada **MTZ tipe Fixed ULP Port harus dibeli terpisah** karena belum termasuk dalam konfigurasi di atas
- Untuk harga Masterpact MTZ dengan modul Komunikasi, silakan [lihat halaman 7-21](#)

Air Circuit Breaker (ACB)

PPACB

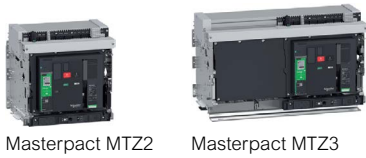

Masterpact MTZ2 Masterpact MTZ3



Micrologic 2.0X Digital Module
MTZ App Handphone



■ Untuk pemesanan, silakan gunakan product code pada Product Selector.
■ Masterpact dan kelengkapannya hanya dapat dirakit oleh PT Schneider Indonesia.

MasterPact™ MTZ 2/3

Air Circuit Breaker 800 s/d 6300A

Masterpact MTZ2/3 Tipe H2 + Micrologic 2.0X Electrically Operated

- Arus nominal : 800A s/d 6300A.
- Kapasitas Pemutusan : 66 kA s/d 100 kA pada 380/440V.
- Icu = Ics = Icw_(1sec) = 66kA (800-4000A) dan 100kA (5000-6300A).
- Full Discriminated sampai downstream breaker Kapasitas Pemutusan (grafik tersedia)
- Upgrade Anytime, Anywhere dengan MTZ Digital Modules ([halaman 7-22](#)).
- Zone selective interlocking (ZSI) dengan 2.0X/5.0X/6.0X
- Trip unit **Micrologic 2.0X**, memiliki 3 setelan :
 - long time protection (proteksi beban lebih) : **Ir = 0.4 In s/d 1n** dengan 9 setelan.
 - time delay untuk long time protection (t_l).
 - instantaneous protection (proteksi hubung singkat) : **I_{sd} = 1.5 Ir s/d 10 Ir** dengan 9 setelan.
- Dual settings functions
- Class 1 embedded Metering: current, voltage, active/reactive/apparent Power & Energy, Power Factor, Frequency, Unbalance dan THD voltage & current
- 3 atau 4 pole, fixed atau drawout type
- Memenuhi standar IEC 60947-2.
- Rating netral penuh dengan perlindungan built in

Spesifikasi standar

- Digital Module (Software App) - Energy per Phase
- Gear Motor (MCH) 200-240VAC + Closing Release (XF) 200-240VAC + Opening Release (MX) 200-240VAC
- Mekanisme pegas dengan sistem energi tersimpan.
- Horizontal rear connection (800-5000A) dan Vertikal rear connection (6300A)
- Auxiliary switches (4 changeover contact OF + SDE).
- Arc chute cover dan safety shutter untuk drawout type.
- CD&CE&CT Position Contacts untuk Drawout Type tanpa EIFE

In (A)	Icu (kA)	3P Referensi	Product Code	Harga (Rp) (Sebelum PPN)	SS	4P Referensi	Product Code	Harga (Rp) (Sebelum PPN)	SS
Type Electrical Fixed									
MTZ08	800	100	MTZ208H22.0X3PEF	WECFAAANNNNNNNNNN-CEENNN*ANNNNNNN	79.506.000	MTZ208H22.0X4PEF	WECFABANNNNNNNNNN-CEENNN*ANNNNNNN	91.985.000	
MTZ10	1000	100	MTZ210H22.0X3PEF	WEDGAAANNNNNNNNNN-CEENNN*ANNNNNNN	84.343.000	MTZ210H22.0X4PEF	WEDGABANNNNNNNNNN-CEENNN*ANNNNNNN	99.071.000	
MTZ12	1250	100	MTZ212H22.0X3PEF	WEEIAAANNNNNNNNNN-CEENNN*ANNNNNNN	85.736.000	MTZ212H22.0X4PEF	WEEIABANNNNNNNNNN-CEENNN*ANNNNNNN	101.462.000	
MTZ16	1600	100	MTZ216H22.0X3PEF	WEFJAAANNNNNNNNNN-CEENNN*ANNNNNNN	99.562.000	MTZ216H22.0X4PEF	WEFJABANNNNNNNNNN-CEENNN*ANNNNNNN	119.310.000	
MTZ20	2000	100	MTZ220H22.0X3PEF	WEGKAAANNNNNNNNNN-CEENNN*ANNNNNNN	107.422.000	MTZ220H22.0X4PEF	WEGKABANNNNNNNNNN-CEENNN*ANNNNNNN	128.618.000	2 - MTO
MTZ25	2500	100	MTZ225H22.0X3PEF	WEHLAAANNNNNNNNNN-CEENNN*ANNNNNNN	141.108.000	MTZ225H22.0X4PEF	WEHLABANNNNNNNNNN-CEENNN*ANNNNNNN	156.682.000	2 - MTO
MTZ32	3200	100	MTZ232H22.0X3PEF	WEIPAAANNNNNNNNNN-CEENNN*ANNNNNNN	153.831.000	MTZ232H22.0X4PEF	WEIPABANNNNNNNNNN-CEENNN*ANNNNNNN	185.063.000	
MTZ40	4000	100	MTZ240H22.0X3PEF	WEJRAAANNNNNNNNNN-CEENNN*ANNNNNNN	255.199.000	MTZ240H22.0X4PEF	WEJRABANNNNNNNNNN-CEENNN*ANNNNNNN	284.682.000	
MTZ50	5000	150	MTZ350H22.0X3PEF	YEKSAAANNNNNNNNNN-CEENNN*ANNNNNNN	425.051.000	MTZ350H22.0X4PEF	YKESABANNNNNNNNNN-CEENNN*ANNNNNNN	435.594.000	
MTZ63	6300	150	MTZ363H22.0X3PEF	YELUAAANNNNNNNNNN-CEENNN*ANNNNNNN	540.921.000	MTZ363H22.0X4PEF	YELUABANNNNNNNNNN-CEENNN*ANN	593.550.000	
Type Electrical Drawout									
MTZ08	800	100	MTZ208H22.0X3PED	WECFADAANNNNNNNNNN-CEENNN*ANNNNNNN	104.618.000	MTZ208H22.0X4PED	WECFAEAANNNNNNNNNN-CEENNN*ANNNNNNN	120.669.000	
MTZ10	1000	100	MTZ210H22.0X3PED	WEDGADAANNNNNNNNNN-CEENNN*ANNNNNNN	109.455.000	MTZ210H22.0X4PED	WEDGAEAANNNNNNNNNN-CEENNN*ANNNNNNN	127.755.000	
MTZ12	1250	100	MTZ212H22.0X3PED	WEEIADAANNNNNNNNNN-CEENNN*ANNNNNNN	110.848.000	MTZ212H22.0X4PED	WEEIAEAANNNNNNNNNN-CEENNN*ANNNNNNN	130.146.000	
MTZ16	1600	100	MTZ216H22.0X3PED	WEFJADAANNNNNNNNNN-CEENNN*ANNNNNNN	124.674.000	MTZ216H22.0X4PED	WEFJAEAANNNNNNNNNN-CEENNN*ANNNNNNN	147.994.000	
MTZ20	2000	100	MTZ220H22.0X3PED	WEGKADAANNNNNNNNNN-CEENNN*ANNNNNNN	132.534.000	MTZ220H22.0X4PED	WEGKAEAANNNNNNNNNN-CEENNN*ANNNNNNN	157.302.000	2 - MTO
MTZ25	2500	100	MTZ225H22.0X3PED	WEHLADAANNNNNNNNNN-CEENNN*ANNNNNNN	167.861.000	MTZ225H22.0X4PED	WEHLAEAANNNNNNNNNN-CEENNN*ANNNNNNN	194.516.000	2 - MTO
MTZ32	3200	100	MTZ232H22.0X3PED	WEIPADAANNNNNNNNNN-CEENNN*ANNNNNNN	188.429.000	MTZ232H22.0X4PED	WEIPAEAANNNNNNNNNN-CEENNN*ANNNNNNN	237.644.000	
MTZ40	4000	100	MTZ240H22.0X3PED	WEJRAEAANNNNNNNNNN-CEENNN*ANNNNNNN	298.824.000	MTZ240H22.0X4PED	WEJRAEAANNNNNNNNNN-CEENNN*ANNNNNNN	344.929.000	
MTZ50	5000	150	MTZ350H22.0X3PED	YEKSAEAANNNNNNNNNN-CEENNN*ANNNNNNN	521.490.000	MTZ350H22.0X4PED	YEKSAEAANNNNNNNNNN-CEENNN*ANNNNNNN	573.989.000	
MTZ63	6300	150	MTZ363H22.0X3PED	YELUADEANNNNNNNNNN-CEENNN*ANNNNNNN	637.360.000	MTZ363H22.0X4PED	YELUAEEANNNNNNNNNN-CEENNN*ANNNNNNN	731.945.000	

Catatan :

- Apabila arus < 20% In, harus ditambahkan external power supply AD module atau VPS (Voltage Power Supply Module) atau Mobile Power Pack agar metering dapat berfungsi.
- Hanya dapat ditampilkan di Micrologic display atau MTZ App di Hand Phone atau di FDM121 Display module.
- Masterpact MTZ3 6300A hanya tersedia dengan vertical rear connection.
- Untuk harga Masterpact MTZ dengan Trip Unit Micrologic lainnya, silakan [lihat halaman 7-19](#)

- Referensi untuk ACB MTZ2 2500A H2 4 Pole D/O Mic 2.0X Koneksi Horizontal terdapat pada buku Price List yaitu MTZ225H22.0X4PED, jika menginginkan koneksi vertikal silakan gunakan konfigurasi Product Selector
- Pada **MTZ tipe Fixed ULP Port harus dibeli terpisah** karena belum termasuk dalam konfigurasi di atas
- Untuk harga Masterpact MTZ dengan modul Komunikasi, silakan [lihat halaman 7-21](#)

Air Circuit Breaker (ACB)

PPACB

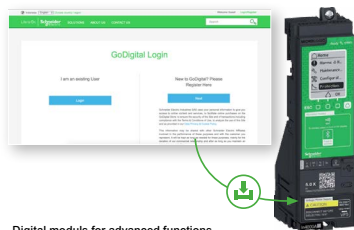

Digital modules for advanced functions



External Sensor



Voltage Power Sensor



External Power Supply



Mobile Powerpack

MasterPact™ MTZ 2/3

Micrologic Trip Unit (dirakit oleh PT Schneider Indonesia)

Micrologic Trip Unit

Harga Micrologic trip unit di bawah ini adalah harga penambahan pada Masterpact MTZ dengan trip unit Micrologic 2.0X (lihat halaman 7-15, 7-16, 7-17, 7-18)

Micrologic Trip Unit		Harga (Rp) (Sebelum PPN)
Masterpact MTZ		
Micrologic 5.0X	selective protection	8.718.000
Micrologic 6.0X	selective + earth fault protection	22.978.000
Micrologic 7.0X	selective + earth leakage protection	93.491.000
Rectangular sensor for earth-leakage protection		56.518.000

Digital Module		Harga (Rp) (Sebelum PPN)
Masterpact MTZ		
Energy per Phase (analysis of energy consumption per phase)		Standar
Under voltage & over voltage (ANSI code 27 & 59)		2.683.000
Reverse active power (ANSI code 32P)		2.683.000
Ground-fault alarm (ANSI code 51N/51G)		2.683.000
Energy Reduction Maintenance Settings (internal arc fault reduce fault clearing time)		2.683.000
Individual harmonics analysis (Individual harmonics of voltage & current upto rank 40)		2.683.000
Power restoration assistant (Recover supply in quick & safe manner)		2.683.000
Masterpact operation assistant (remote reclosing / opening & Voltage release status)		2.683.000
Waveform capture on trip unit (display interrupted phase & neutral current)		2.683.000
Modbus legacy dataset (Compliant with Modbus Legacy format)		2.683.000
Directional Overcurrent (ANSI 67)		2.683.000
IDMTL overcurrent protection (ANSI 51)		2.683.000
IEC 61850 for MasterPact MTZ		2.683.000

Aksesori Micrologic Trip Unit

Aksesori		Harga (Rp) (Sebelum PPN)
External Sensors		
External sensor untuk earth-fault protection (TCE)		
	400/2000 A	13.529.000
Sensor rating	1000/4000 A	15.791.000
	4000/6300 A (MTZ 3)	29.855.000
Voltage Power Supply module (VPS) for Micrologic X		
Zone Selective Interlocking option for Micrologic X		Standar
External Power Supply Module (AD Module)		6.470.000
Battery Module		5.540.000

Test and commissioning equipment		Harga (Rp) (Sebelum PPN)
USB cable (mini USB / USB) for Micrologic X		333.000
Mobile Powerpack for Micrologic X		2.518.000

Catatan :

- Micrologic 7.0X hanya dapat dipasang pada Masterpact MTZ sampai dengan rating 3200 A.
- Seiring Dengan Micrologic 7.0X wajib agar sensor Rectangular (33574) untuk merasakan arus kebocoran bumi.



Micrologic X trip unit harus dipesan dengan circuit breaker yang diperlukan dan dirakit oleh PT Schneider Indonesia.



MCH



XF / MX



BPFE



MX / MN



OF



SDE

MasterPact™ MTZ

Aksesori Masterpact MTZ (dirakit oleh PT Schneider Indonesia)

Kontak Bantu

Remote ON/OFF

Auxiliaries		Harga (Rp) (Sebelum PPN)
Gear Motor (MCH)		14.357.000
Instantaneous Voltage Releases		
Closing Release (XF)	Standar	2.546.000
	Diagnostics & Communicating	2.546.000
Opening release (MX)	Standar	2.546.000
	Diagnostics & Communicating	2.546.000
"Ready To Close" Contact (PF)		
1 Changeover Contact (5 A - 240 V)		1.513.000
Electrical Closing Pushbutton (BPFE)		
1 Pushbutton		1.293.000
Remote Reset After Fault Trip		
Electrical Reset (Res)		9.486.000

Remote Tripping

Fungsi remote tripping digunakan untuk membuka breaker secara elektrik, terdiri dari :

- 1 Shunt Release (MX).
- Atau 1 Under Voltage Release (MN) : membuka breaker jika tegangan supply berada antara 35% sampai 70% Un.
- Atau 1 Delayed Under Voltage Release (MN + delay unit).

Auxiliaries		Harga (Rp) (Sebelum PPN)
Instantaneous Voltage Release		
Shunt Release (2nd MX)		2.756.000
Under Voltage Release (MN) - Standar		3.557.000
Under Voltage Release (MN) - Diagnostic		3.735.000
MN delay unit		
Unit tunda waktu untuk Under Voltage Release.		
Non-adjustable (R)		4.262.000
Adjustable (Rr)		3.819.000

Indication Contacts		Harga (Rp) (Sebelum PPN)
ON/OFF Indication Contacts (OF)		
Block of 4 changeover contacts	6A - 240V	1 block (standar)
1 additional block of 4 contacts (2 max)		3.215.000
"Fault trip" Indication Contacts (SDE)		
Changeover contact	5A - 240V	1 (standar)
1 additional SDE		950.000

Catatan :

- Aksesori ini dapat dipesan melalui Product Selector dan dirakit oleh PT Schneider Indonesia.
- Aksesori ini hanya dapat dipasang pada produk Masterpact MTZ.

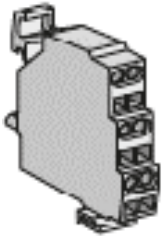

MasterPact™ MTZ

Aksesori (dirakit oleh PT Schneider Indonesia)

Komunikasi

■ Modul Komunikasi

Modul Komunikasi	Harga (Rp) (Sebelum PPN)
Tipe Drawout MTZ2/MTZ3	
ULP Port (Standar)	7.875.000
EIFE (Embedded Ethernet Interface for breaker)	6.696.000
IFE (Ethernet Interface for LV breaker)	7.380.000
IFE (Ethernet Interface for LV breaker & Gateway)	2.561.000
IFM (Modbus Interface)	8.959.000
I/O application module	
Tipe Fixed MTZ2/MTZ3	
ULP Port (Mandatory)	3.021.000
IFE (Ethernet Interface for LV breaker)	6.696.000
IFE (Ethernet Interface for LV breaker & Gateway)	7.380.000
IFM (Modbus Interface)	2.561.000
I/O application module	8.959.000
Carriage Switches (Connected / Disconnected / Test Position)	
Changeover Contacts (8A - 240V)	
1 Connected position contact (3max)	715.000
1 Test position contact (3max)	715.000
1 Disconnected position contact (3max)	715.000
Extended Warranty	
MTZ 3 years warranty period	2.364.000
MTZ 5 years warranty period	11.828.000

Catatan :

- ULP Port pada MTZ Drawout sudah termasuk ke dalam konfigurasi
- ULP Port pada MTZ Fixed harus dibeli secara terpisah karena **belum** termasuk ke dalam konfigurasi
- Aksesori ini dapat dipesan melalui Product Selector dan dirakit oleh PT Schneider Indonesia.
- Aksesori ini hanya dapat dipasang pada produk Masterpact MTZ

Air Circuit Breaker (ACB)

PPACB

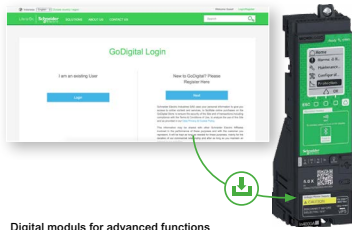

Digital modules for advanced functions

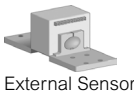

External Sensor

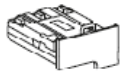

Voltage Power Sensor



Power Supply



Mobile Powerpack

MasterPact™ MTZ

Aksesori Masterpact MTZ (Spares)

Aksesori Micrologic Trip Unit

Aksesori Micrologic Trip Unit

Digital Module (MTZ Apps)	Referensi	Harga (Rp) (Sebelum PPN)
Energy per Phase (analysis of energy consumption per phase)	LV850002X	Standar
Under voltage & over voltage (ANSI code 27 & 59)	LV850012X	2.683.000
Reverse active power (ANSI code 32P)	LV850011X	2.683.000
Ground-fault alarm (ANSI code 51N/51G)	LV850007X	2.683.000
Energy Reduction Maintenance Settings (internal arc fault reduce fault clearing time)	LV850009X	2.683.000
Individual harmonics analysis (Individual harmonics of voltage & current upto rank 40)	LV850006X	2.683.000
Power restoration assistant (Recover supply in quick & safe manner)	LV850004X	2.683.000
Masterpact operation assistant (remote reclosing / opening & Voltage release status)	LV850005X	2.683.000
Waveform capture on trip unit (display interrupted phase & neutral current)	LV850003X	2.683.000
Modbus legacy dataset (Compliant with Modbus Legacy format)	LV850045X	2.683.000
Directional Overcurrent (ANSI 67)	LV850015X	2.683.000
IDMTL overcurrent protection (ANSI 51)	LV850037X	2.683.000
IEC 61850 for MasterPact MTZ	LV850046X	2.683.000

Aksesori Micrologic Trip Unit

Aksesori	Referensi	Harga (Rp) (Sebelum PPN)	SS
External sensor untuk earth-fault protection (TCE).	Sensor rating 400/2000 A	LV834035SP	13.529.000 2 - MTO
	1000/4000 A	LV834036SP	15.791.000 2 - MTO
	4000/6300 A (MTZ 3)	LV848182SP	29.855.000 2 - MTO
Rectangular sensor for earth-leakage + Vigi cable (upto 3200A)	280 mm x 115 mm	LV833573SP	53.826.000 2 - MTO
	470 mm x 160 mm	LV833574SP	53.826.000 2 - MTO
Voltage Power Supply Module (VPS) for Micrologic X	LV850060SP	6.470.000 2 - MTO	
External Power Supply Module (AD Module) 200-240 VAC	LV454444	5.540.000 2 - MTO	

Test and commisionning equipment	Referensi	Harga (Rp) (Sebelum PPN)	SS
USB cable (mini USB / USB) for Micrologic X	LV850067SP	333.000 2 - MTO	
Mobile Powerpack for Micrologic X	LV850055SP	2.518.000 2 - MTO	

Catatan :

- Micrologic 7.0X hanya dapat dipasang pada Masterpact MTZ sampai dengan rating 3200 A.
- Seiring Dengan Micrologic 7.0X wajib agar sensor Rectangular untuk mendeteksi arus kebocoran tanah.

MasterPact™ MTZ

Aksesori Masterpact MTZ (Spares)

Remote On/OFF, Tripping

■ Remote ON/OFF

Fungsi remote ON/OFF digunakan untuk membuka dan menutup breaker dari jarak jauh, terdiri dari:

- 1 Gear motor (MCH): Untuk pengoperasian secara elektrik, mengisi spring mechanism secara otomatis saat breaker tertutup sehingga memungkinkan instantaneous reclosing ketika breaker terbuka.
- 2 Voltage release:
 - 1 Closing release (XF coil) : Menutup breaker dari jarak jauh jika spring mechanism discharge.
 - 1 Closing release (XF diag&com) : Diagnostik dan berkomunikasi closing voltage release
 - 1 Opening release (MX) : Membuka breaker bila diberi tegangan supply (0.7 - 1.1 Un).
 - 1 Opening release (MX diag&com) : Diagnostik dan berkomunikasi opening voltage release

Sebagai pilihan, dapat ditambahkan fungsi:

- "Ready to close" contact : Mengecek keadaan breaker, sebelum pemutusan secara manual/ elektrik.
- Electrical closing pushbutton : Menutup breaker secara elektrik.
- Remote reset following a fault : Mereset SDE dan reset button, setelah breaker trip.

Biasanya dilengkapi dengan:

- ON/OFF indication contact (OF).
- "Fault trip" indication contact (SDE).



MCH



XF / MX



XF / MX



BPFE

Remote On/Off; Tripping	Referensi	Harga (Rp) <i>(Sebelum PPN)</i>	SS
Gear Motor (MCH)			
MCH motor mechanism 200/240VAC ⁽¹⁾	LV847894SP	14.357.000	1 - MTS
Terminal Block for Tipe Fixed MTZ2/3	LV847074SP	154.000	2 - MTO
Terminal Block for Tipe Drawout MTZ2/3	LV847849SP	154.000	2 - MTO
Closing or Opening release (XF or MX)			
Standar XF / MX coil 200/250V AC/DC ⁽¹⁾	LV833662SP	2.546.000	2 - MTO
Diagnostik & Komunikasi XF / MX 200/250V AC/DC ⁽¹⁾	LV833036SP	2.546.000	2 - MTO
Terminal Block for Tipe Fixed MTZ2/3	LV847074SP	154.000	2 - MTO
Terminal Block for Tipe Drawout MTZ2/3	LV847849SP	154.000	2 - MTO
Under-voltage release (MN)			
Standar MN coil 200/250V AC/DC ⁽¹⁾	LV833671SP	3.557.000	1 - MTS
Diagnostik MN 200/250V AC/DC ⁽¹⁾	LV836671SP	3.735.000	2 - MTO
Terminal Block for Tipe Fixed MTZ2/3	LV847074SP	154.000	2 - MTO
Terminal Block for Tipe Drawout MTZ2/3	LV847849SP	154.000	2 - MTO
MN delay unit			
Unit tunda waktu untuk Under Voltage Release.			
Non-adjustable (R) 200/250V AC/DC	LV833685SP	6.479.000	2 - MTO
Adjustable (Rr) 200/250V AC/DC	LV833682SP	3.819.000	2 - MTO
"Ready To Close" Contact (PF)			
1 Changeover Contact (5 A - 240 V)	LV847080SP	1.513.000	2 - MTO
Terminal Block for Tipe Fixed MTZ2/3	LV847074SP	154.000	2 - MTO
Terminal Block for Tipe Drawout MTZ2/3	LV847849SP	154.000	2 - MTO
Electrical Closing Pushbutton (BPFE)			
1 Pushbutton	LV848534SP	1.293.000	2 - MTO
Remote Reset After Fault Trip			
Electrical Reset (Res) 200/240VAC ⁽¹⁾	LV848203SP	9.486.000	2 - MTO
Terminal Block for Tipe Fixed MTZ2/3	LV847074SP	154.000	2 - MTO
Terminal Block for Tipe Drawout MTZ2/3	LV847849SP	154.000	2 - MTO

Catatan :

- (1) Terminal block wajib untuk digunakan saat menggunakan Aksesori Masterpact MTZ.
- (2) Untuk tegangan kontrol lainnya, silakan hubungi kami.

MasterPact™ MTZ

Aksesori (Spares)

Kontak Bantu

■ Indication Contacts



OF



SDE



M2C

Auxiliaries	Fixed	Harga (Rp) (Sebelum PPN)	SS	Drawout	Harga (Rp) (Sebelum PPN)	SS
ON/OFF Indication Contacts (OF)						
Bekerja jika jarak isolasi minimum antara main contact tercapai.						
Block of 4 changeover contacts	5A - 240V	1 block (standar)		1 block (standar)		
1 additional block of 4 contacts (2 max)		LV864922SP	3.215.000 2 - MTO	LV864922SP	3.215.000 2 - MTO	
Wiring (mandatorily order with block contacts)		LV847074SP x 4	592.000 2 - MTO	LV847849SP x 4	592.000 2 - MTO	
"Fault trip" Indication Contacts (SDE)						
Menunjukkan circuit breaker trip karena adanya gangguan.						
Changeover contact	5A - 240V	1 (standar)		1 (standar)		
1 additional SDE	5A - 240V	LV848200	1.081.000 2 - MTO	LV848475	1.097.000 2 - MTO	
Wiring (mandatorily order with SDE contacts)		LV847074SP x 4	592.000 2 - MTO	LV847849SP x 4	592.000 2 - MTO	
Carriage Switches (Connected / Disconnected / Test Position)						
Menunjukkan posisi circuit breaker : connected, test atau disconnected.						
Changeover Contacts / 1 part				LV833170SP	715.000 2 - MTO	

■ Indication Contacts (Masterpact MTZ)

Auxiliaries	Fixed	Harga (Rp) (Sebelum PPN)	SS	Drawout	Harga (Rp) (Sebelum PPN)	SS
Programmable Contacts						
Menunjukkan jenis gangguan, dapat diprogram dari Micrologic control unit (hanya untuk Micrologic P dan H) atau supervisory station dengan communication option. Harus dilengkapi external power supply module.						
2 contacts (M2C)	5A - 240V	LV847403	1.556.000 2 - MTO	LV848382	1.553.000 2 - MTO	

Catatan : Terminal block (wiring) wajib untuk digunakan saat menggunakan Aksesori Masterpact MTZ.



- Masterpact & kelengkapannya hanya dapat dirakit oleh
- PT Schneider Indonesia. Untuk pemesanan, silakan gunakan product code pada Product Selector.

MasterPact™ MTZ

Aksesori (Spares)

Modul Komunikasi & Koneksi

■ Modul Komunikasi (Communication Module)

Modul komunikasi diperlukan untuk mengintegrasikan circuit breaker ke dalam sistem supervisi, sehingga fungsi proteksi, kontrol dan monitoring dapat dilakukan dari jarak jauh, seperti :

- Identifikasi circuit breaker.
- Indikasi status dan kondisi breaker.
- Setting fungsi proteksi dan alarm.
- Analisa parameter-parameter daya arus bolak balik untuk keperluan pengoperasian dan pemeliharaan.

Masterpact MTZ menggunakan protokol komunikasi Ethernet TCP/IP yang kompatibel dengan sistem manajemen instalasi listrik EcoStruxure Facility Expert / Monitoring Expert / Power SCADA Operation / Building Operation. Untuk komunikasi dengan jaringan lainnya dapat digunakan external gateway seperti Profibus

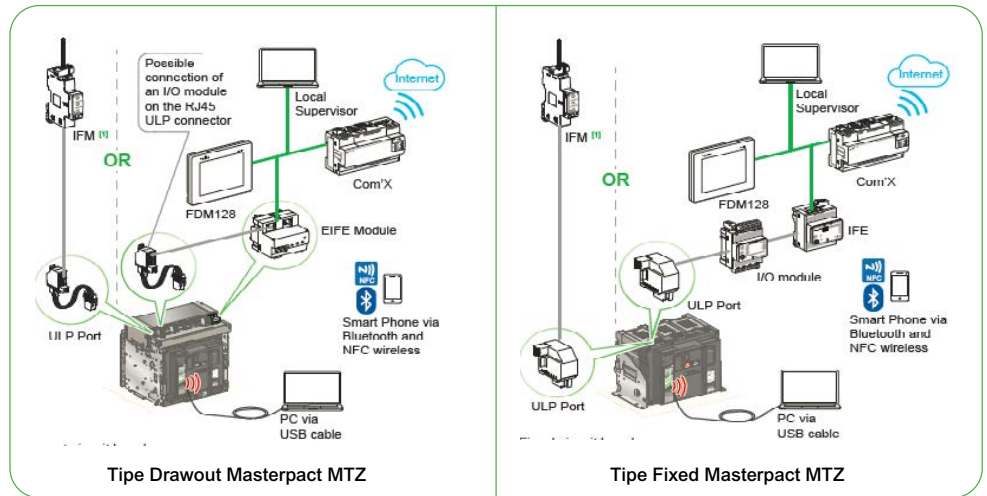

Harga modul komunikasi di bawah ini adalah harga penambahan pada Masterpact MTZ

Modul Komunikasi	Type Fixed			Type Drawout		
	Referensi	Harga (Rp) (Sebelum PPN)	SS	Referensi	Harga (Rp) (Sebelum PPN)	SS
EIFE (Embedded Ethernet Interface for breaker)	Not Applicable			LV851200SP	7.530.000	2 - MTO
IFE (Ethernet Interface for LV breaker)	LV434001	6.682.000	2 - MTO	LV434001	6.682.000	2 - MTO
IFE (Ethernet Interface for LV breaker & Gateway)	LV434002	7.366.000	2 - MTO	LV434002	7.366.000	2 - MTO
IFM (Modbus Interface)	LV434000	2.556.000	2 - MTO	LV434000	2.556.000	2 - MTO
I/O application module	LV434063	8.941.000	2 - MTO	LV434063	8.941.000	2 - MTO
Microswitches for MTZ2/3	LV847905SP	441.000	2 - MTO	LV847905SP	441.000	2 - MTO
Isolation Module for MX1/XF communicating coils	LV850056SP	5.131.000	2 - MTO	LV850056SP	5.131.000	2 - MTO
Internal Com wiring for MX / XF / MN	LV847904SP	441.000	2 - MTO	LV847904SP	441.000	2 - MTO

Catatan :

- Modul Komunikasi harus dipesan dengan circuit breaker yang diperlukan dan dirakit oleh PT Schneider Indonesia.
- Modul Komunikasi harus dipesan bersama dengan Masterpact MTZ.
- Aksesori dan kelengkapan Masterpact harus dipesan bersamaan dengan circuit breakernya dan dirakit oleh PT Schneider Indonesia.

■ Automatic Source Changeover

Automatic Source Changeover (Automatic Transfer Switch - ATS) untuk Masterpact MTZ tersusun dari :

- Sumber 'Normal' lengkap dengan motor mech dan alat bantu (auxiliary contact).
- Sumber 'Pengganti' lengkap dengan motor mech dan alat bantu (auxiliary contact).
- Interlocking system dengan batang rigid (rod) atau kabel.
- IVE (electrical interlocking unit).
- ACP (auxiliary control plate).
- BA atau UA controller.

Catatan :

- Setiap circuit breaker harus dilengkapi dengan 1 MCH, 1 MX (atau MN), 1 XF, 1 PF, 1 OF (dan 1 CE untuk tipe drawout).
- Tegangan supply circuit breaker auxiliaries (MCH, MX/MN, XF) dan automatic control equipment (IVEA, CP, BA/UA) harus sama.

■ Interlocking System Untuk 2 Breaker

Interlocking System	MTZ	Harga (Rp) (Sebelum PPN)	SS
Interlocking Dengan Batang Rigid (Connecting Rod)			
Complete assembly dengan 2 adaptation fixture + rod			
1 set of 2 adaptation fixture untuk Masterpact MTZ 2/3 Fixed / Drawout type	LV847930SP	13.243.000	2 - MTO
1 set of 2 interlocking rods	LV833210SP	13.243.000	2 - MTO
Interlocking Dengan Kabel			
Pilih 2 adaptation fixture (1 untuk setiap breaker) + 1 set kabel			
1 adaptation fixture untuk Masterpact <u>fixed type</u>	LV847926SP	5.692.000	2 - MTO
1 adaptation fixture untuk Masterpact <u>drawout type</u>	LV847926SP	5.692.000	2 - MTO
1 set of 2 cables	LV833209SP	3.785.000	2 - MTO

■ IVE Electrical Interlocking Unit

IVE	48...415 VAC	Harga (Rp) (Sebelum PPN)	SS
IVE untuk 2 CB	29352	11.026.000	2 - MTO
Wiring kit untuk menghubungkan breaker dengan IVE	54655	4.035.000	2 - MTO

■ Automatic Controller

Controller	220/240 VAC	Harga (Rp) (Sebelum PPN)	SS	380/415 VAC	Harga (Rp) (Sebelum PPN)	SS
ACP + BA controller	29470	38.725.000	2 - MTO	29471	40.082.000	2 - MTO
ACP + UA controller	29472	50.820.000	2 - MTO	29473	49.208.000	2 - MTO

■ Interlocking System Untuk 3 Breaker (Masterpact MTZ)

Interlocking System	MTZ	Harga (Rp) (Sebelum PPN)	SS
Interlocking Dengan Kabel			
1 complete set dengan 3 adaptation fixture + kabel			
3 sumber, hanya 1 ON	LV848610SP	40.960.000	2 - MTO
2 sumber, 1 coupling	LV848609SP	40.960.000	2 - MTO
2 sumber normal, 1 sumber pengganti	LV848608SP	40.960.000	2 - MTO

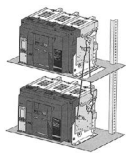

Interlocking System untuk 2 Breaker



IVE Electrical Interlocking unit



Automatic Controller

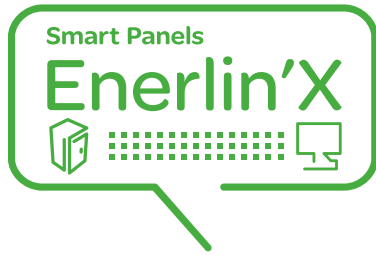

Smart Panels dari Schneider Electric

membuat pengelolaan energi di dalam gedung menjadi lebih sederhana, aman dan lebih efisien yang tentunya berdampak langsung kepada efisiensi energi – melalui tiga langkah mudah.

- Mengukur (Measure)
- Menghubungkan (Connect)
- Menyimpan data (Act)

Tiga langkah mudah ini dapat dilakukan dengan pemasangan yang mudah sesuai dengan arsitektur berikut:

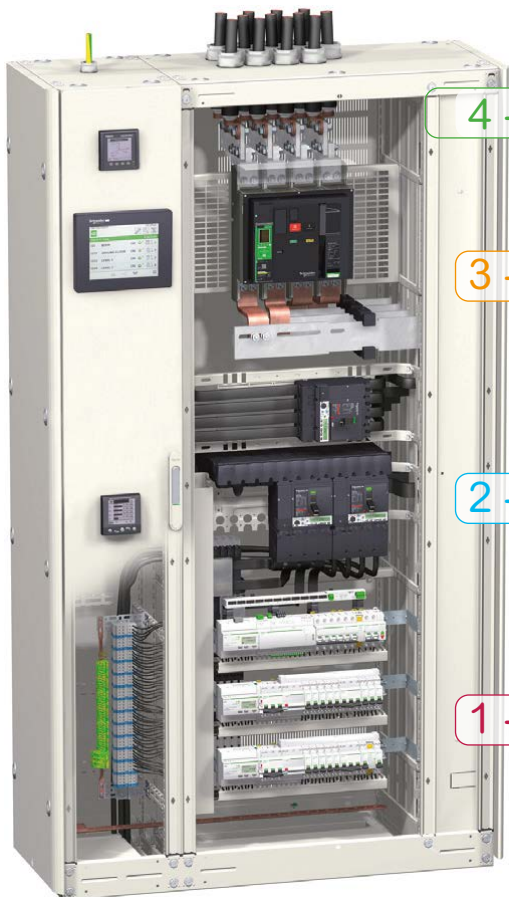

4 - Act

3 - Connect

Give a voice to the panel

Safe Ethernet network data transmission is now part of the intrinsic design of protection and metering devices.

2 - Measure

Keeping a close eye on energy flows

The switchboard plays a key role in capturing building-related data, by gathering the critical protection and metering components.

1 - Protect

Electrical protection is at the core of Smart Panel

Reliable and high-performance technology is present in every breaker and every residual current device.

■ Act in small/medium buildings

with FDM 128, Com'X 510, Power View, EcoStruxure™ Facility Expert



Optimizing energy-efficiency

- Visualize, record energy consumption and WAGES.
- Comply with regulation .

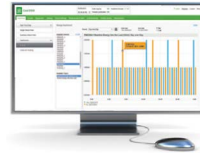

Improving continuity of service

- Get instant notifications
- Manage with assets-maintenance platform
- Get and analyze data for quick crisis-recovery



Increasing maintenance efficiency

- Operate preventive maintenance tools
- Follow maintenance & planning
- Provide business owner instant access to maintenance reports

■ Act in large non-critical buildings

with EcoStruxure™ Energy Expert



Managing equipment & key assets

- Check operating status, faults on custom on-line diagrams.



Monitoring electrical network

- Observe voltage disturbances, harmonics on graphics.
- Read power factor.



Accounting energy

- Record power meter data on dashboards.
- Allocate energy consumption with costs.
- Follow conservation goals.

■ Act in large critical buildings

with EcoStruxure™ Power Monitoring Expert [1]



Analysing Power Events

- Speed up downtime crisis recovery
- Determine incident root cause, events sequence.
- Troubleshoot power quality issues.



Monitoring Power quality

- Be alerted of equipment affected by power quality issue.
- Compare power quality against industry standards.
- Collect facts for future discussion with Utility.



Analysing Energy Performance

- Evaluate building energy saving performance;
- Identify underperforming loads;
- Analyze Energy Conservation Measures (ECMs) according ISO50001 program.

Air Circuit Breaker (ACB)

PPACB



Smart Panel Enerlin'X

Nama Produk	Fungsi	Referensi	Harga (Rp) <i>(Sebelum PPN)</i>
EcoStruxure Panel Server Advanced	Energy Server dengan fungsi Ethernet Gateway dan sensor concentrator	PAS800L	15.308.000
FDM128	<i>Front Display Module Ethernet LCD touch screen</i>	LV434128	10.095.000,00
FDM121	<i>Front Display Module LCD</i>	TRV00121	4.522.000,00
IFE Interface+ Gateway	Ethernet Interface + Gateway untuk Circuit Breaker	LV434002	7.366.000,00
IFE Interface	Ethernet Interface Circuit Breaker	LV434001	6.682.000,00
Acti9 Smartlink Modbus	Modbus Interface dengan fungsi input/output	A9XMSB11	7.490.000
IFM	Modbus Interface Untuk Circuit Breaker	LV434000	2.556.000,00
I/O Module	Modul input/output untuk Circuit Breaker	LV434063	8.941.000,00



TPRBOPFN
TeSys

TPRVM001
TeSys

TPRST009
TeSys

TPRST065
TeSys

TPRSS080
TeSys

Schneider Electric

Schneider Electric

Schneider Electric

Schneider Electric

Schneider Electric

Schneider Electric

Voltage Interface

starter

starter

starter

Safety Interface

PWR
SF
BF
BS
SB

DS
VS

BS
LS

BS
LS

BS
LS

2T1
4T2
6T3

2T1
4T2
6T3

2T1
4T2
6T3

Motor Starter & Sistem Proteksi Motor

Pembaruan dalam TeSys	8-4
TeSys Control - Kontaktor 3 Kutub	8-5
TeSys Control Easy TeSys (6 - 630 A)	8-5
TeSys K (6 - 16 A)	8-6
TeSys Deca (9 - 150 A)	8-7
TeSys Deca Green (AC/DC) (9 - 80 A)	8-8
TeSys Control - Kontaktor 4 Kutub	8-9
TeSys Control Easy TeSys (6 - 95 A) (AC-1)	8-9
TeSys Deca (20 - 125 A) (AC-1)	8-10
Aksesori Kontaktor TeSys K & TeSys Deca	8-11
TeSys Giga	8-14
TeSys Control - Kontaktor Giga Tipe Standard	8-15
TeSys Control - Kontaktor Giga Tipe Advanced	8-16
TeSys Protect - Relay Beban Lebih Elektronik LR9G	8-17
TeSys Protect - Relay Beban Lebih Termal	8-19
Easy TeSys Protect LRE	8-19
TeSys Protect LR2K	8-20
TeSys Protect LRD	8-21
Aksesori LRD	8-22
TeSys Protect - Electronic Over Current Relay (EOCR)	8-23
TeSys Power - Motor Circuit Breaker	8-24
TeSys Power Deca - GV2 & GV3 (Proteksi Magnetik)	8-24
TeSys Power Deca - GV2 & GV3 (Proteksi Magnetik Termal)	8-25
TeSys Power Deca - GV4 (Proteksi Magnetik)	8-30
TeSys Power Deca - GV4 (Proteksi Magnetik Termal)	8-31
TeSys Power Giga - GV5 & GV6 (Panorama Produk)	8-32
TeSys Power Giga - GV5 & GV6 (Proteksi Magnetik Termal)	8-33
TeSys Control - Relay Kontrol	8-37
Relay Kontrol TeSys K & TeSys Deca	8-37
Enclosed Motor Starter	8-38
Direct On Line - Non Reverse	8-38
TeSys Active - TeSys Ultra	8-39
Motor Starter 1 Komponen Koordinasi Total	8-39
TeSys Active - TeSys T	8-40
Sistem Manajemen Motor	8-40
TeSys Active - TeSys island	8-41
Panorama Produk TeSys island	8-41
TeSys island - Sistem Pengendalian / Proteksi / Pemantauan Motor	8-42

Motor Starter & Sistem Proteksi Motor

Petunjuk Pemilihan Motor Starter Direct On Line (Easy TeSys)	8-44
Koordinasi Tipe 1 (performa standard)	8-44
Petunjuk Pemilihan Motor Starter Star Delta (Easy TeSys)	8-45
Koordinasi Tipe 1 (performa standard)	8-45
Petunjuk Pemilihan Motor Starter Direct On Line	8-46
Koordinasi Tipe 1 (performa standard)	8-46
Koordinasi Tipe 2 (performa tinggi)	8-47
Petunjuk Pemilihan Motor Starter Star Delta	8-48
Koordinasi Tipe 1 (performa standard)	8-48
Koordinasi Tipe 2 (performa tinggi)	8-49

Pembaruan dalam TeSys



■ Aspek Visual TeSys

Desain dari rangkaian produk utama TeSys berevolusi: Motor Circuit Breaker, Kontaktor, dan beberapa komponen lainnya yang ke depannya akan memberikan tampilan yang lebih modern, sehingga memberikan aspek visual yang berkelas pada panel kontrol.

Identitas Schneider Electric secara jelas dicitrakan pada bagian berwarna hijau.



■ Penamaan Baru TeSys Berdasarkan Fungsi

Penamaan komponen-komponen TeSys kini dikelompokkan berdasarkan fungsinya, untuk memudahkan identifikasi. Fungsi-fungsi ini berkaitan dengan daya (**power**), pengendalian (**control**) dan perlindungan (**protection**) pada motor.



■ **TeSys Power**
Komponen yang memberikan daya (power) pada motor.



■ **TeSys Control**
Komponen yang mengendalikan motor.



■ **TeSys Protect**
Komponen untuk melindungi motor.



■ **TeSys Active**
Komponen yang terkoneksi (connected) untuk rangkaian motor.



■ Nama Baru Rangkaian Produk TeSys

Penamaan rangkaian produk konvensional berdasarkan besaran kelas arus:

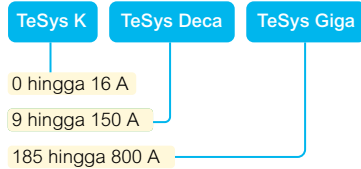

Komponen TeSys yang lebih *advanced* memiliki klasifikasi yang spesifik, yakni:

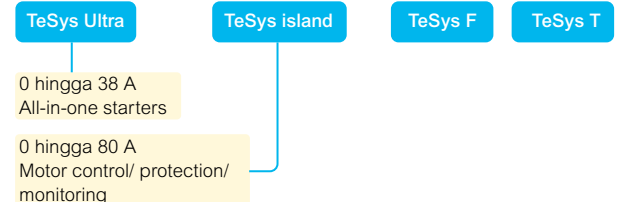

Komponen TeSys lainnya tidak berubah



Informasi lengkap tentang produk dan penamaan baru **TeSys** dapat dilihat pada katalog TeSys terbaru kami.



Scar QR code berikut untuk mengunduh **Katalog TeSys terbaru**.



Scan untuk
Data Teknis



LC1E06 ●●●●●



LC1E65 ●●



LC1E120 ●●



LC1E300 ●●



LAEN20



LAETSD

TeSys Control Easy TeSys

Kontaktor 3 kutub dari 6A sampai dengan 630A

Kontrol AC

Arus AC-1 (A)	Daya Motor AC-3 380/400 V (kW)	Arus AC-3 (A)	Kontak Bantu		Referensi	Harga (Rp) (Sebelum PPN)	SS
			N/O	N/C			
Koneksi Standard							
20	2.2	6	1	0	LC1E0610M7	232.000	1
20	2.2	6	0	1	LC1E0601M7	232.000	2
25	4	9	1	0	LC1E0910M7	254.000	1
25	4	9	0	1	LC1E0901M7	254.000	1
25	5.5	12	1	0	LC1E1210M7	278.000	1
25	5.5	12	0	1	LC1E1201M7	278.000	2
32	7.5	18	1	0	LC1E1810M7	379.000	1
32	7.5	18	0	1	LC1E1801M7	379.000	1
36	11	25	1	0	LC1E2510M7	488.000	1
36	11	25	0	1	LC1E2501M7	488.000	2
50	15	32	1	0	LC1E3210M7	685.000	1
50	15	32	0	1	LC1E3201M7	685.000	1
50	18.5	38	1	0	LC1E3810M7	845.000	2
50	18.5	38	0	1	LC1E3801M7	845.000	2
60	18.5	40	1	1	LC1E40M7	1.149.000	1
70	22	50	1	1	LC1E50M7	1.303.000	2
80	30	65	1	1	LC1E65M7	1.916.000	1
110	37	80	1	1	LC1E80M7	2.053.000	1
120	45	95	1	1	LC1E95M7	2.480.000	1
150	55	120	1	1	LC1E120M5	3.213.000	1
200	75	160	1	1	LC1E160M5	4.254.000	1
250	90	200	-	-	LC1E200M5	8.019.000	1
300	132	250	-	-	LC1E250M5	9.265.000	2
320	160	300	-	-	LC1E300M5	19.615.000	2
500	200	400	-	-	LC1E400M7	25.505.000	2
700	250	500	-	-	LC1E500M7	30.372.000	2
1000	335	630	-	-	LC1E630M7	30.431.000	2

Catatan :

- Coil M7 ataupun M5 adalah untuk aplikasi pada 220 V AC.
- Untuk tipe tegangan coil lainnya silakan hubungi Customer Care Center kami.
- Berikut adalah kode coil untuk tegangan lain. **Harga dapat berbeda** dari yang tertera di atas

	Koil	Koil	24	48	110	220	230	240	380	415	440
LC1E06-300	50 Hz	B5	E5	F5	M5	-	U5	Q5	N5	R5	
	60 Hz	B6	-	F6	M6	-	-	Q6	-	R6	
LC1E06-95	50/60Hz	B7	E7	F7	M7	P7	-	Q7	-	-	
LC1E400-630	50/60Hz	-	E7	F7	M7	-	U7	Q7	N7	-	

Kontak Bantu Seketika

Deskripsi	Jumlah Kontak	N/O	N/C	Referensi	Harga (Rp) (Sebelum PPN)	SS
Kontak Bantu Seketika Mounting Depan	2	1	1	LAEN11	70.000	1
	4	2	2	LAEN22	131.000	2
	2	2	0	LAEN20	73.000	2

Kontak Blok Tunda Waktu

Tipe	Setting Waktu	N/O	N/C	Referensi	Harga (Rp) (Sebelum PPN)	SS
Kontak Blok Tunda Waktu	1 s/d 30 s	1	1	LAETSD	1.001.000	2



Scan untuk
Data Teknis



LC1K0910 ● ●



LP1K0910 ● ●

TeSys Control

TeSys K

Kontaktor 3 Kutub dari 6A sampai dengan 16A

■ Kontrol AC

AC-1 (A)	AC-3 380/415 V		Kontak Bantu		Referensi	Harga (Rp) (Sebelum PPN)	SS
	(kW)	(A)	N/O	N/C			
20	2,2	6	1	-	LC1K0610M7	345.000	1
			-	1	LC1K0601M7	345.000	1
20	4	9	1	-	LC1K0910M7	363.000	1
			-	1	LC1K0901M7	363.000	1
20	5,5	12	1	-	LC1K1210M7	432.000	1
			-	1	LC1K1201M7	432.000	2
20	7,5	16	1	-	LC1K1610M7	674.000	2
			-	1	LC1K1601M7	674.000	2

Catatan :

- Coil **M7** adalah untuk aplikasi pada **220 V AC**.
- Untuk tipe tegangan coil lainnya silakan hubungi Customer Care Center kami.
- Berikut adalah kode coil untuk tegangan lain. **Harga dapat berbeda** dari yang tertera di atas

Tegangan AC (Volts)	24	48	110	230	380
Kode Koil	B7	E7	F7	P7	Q7

■ Kontrol DC

AC-1 (A)	AC-3 380/415 V		Kontak Bantu		Referensi	Harga (Rp) (Sebelum PPN)	SS
	(kW)	(A)	N/O	N/C			
20	2,2	6	1	-	LP1K0610BD	455.000	1
			-	1	LP1K0601BD	455.000	2
20	4	9	1	-	LP1K0910BD	478.000	1
			-	1	LP1K0901BD	478.000	2
20	5,5	12	1	-	LP1K1210BD	633.000	2
			-	1	LP1K1201BD	633.000	2

Catatan :

- Coil **BD** adalah untuk aplikasi pada **24 V DC**.
- Untuk tipe tegangan coil lainnya silakan hubungi Customer Care Center kami.
- Berikut adalah kode coil untuk tegangan lain. **Harga dapat berbeda** dari yang tertera di atas

Tegangan DC (Volts)	12	48	110	125	220
Kode Koil	JD	ED	FD	GD	MD



Scan untuk
Data Teknis



LC1D09M7



LC1D65AM7



LC1D95●●●

TeSys Control

TeSys Deca

Kontaktor 3 kutub dari 9A sampai dengan 150A

■ Kontrol AC

AC1 (A)	AC-3 380/415 V		Kontak Bantu		Referensi	Koil AC		Koil DC	
	(kW)	(A)	N/O	N/C		Harga (Rp) (Sebelum PPN)	SS	Harga (Rp) (Sebelum PPN)	SS
Koneksi Standard									
25	4	9	1	1	LC1D09●●	360.000	1	1.053.000	1
25	5,5	12	1	1	LC1D12●●	425.000	1	1.125.000	1
32	7,5	18	1	1	LC1D18●●	556.000	1	1.506.000	1
40	11	25	1	1	LC1D25●●	760.000	1	2.035.000	1
50	15	32	1	1	LC1D32●●	1.034.000	1	2.940.000	1
50	18,5	38	1	1	LC1D38●●	1.260.000	1	3.129.000	2
Koneksi EverLink									
60	18,5	40	1	1	LC1D40A●●	1.752.000	1	4.176.000	2
80	22	50	1	1	LC1D50A●●	2.111.000	1	4.419.000	2
80	30	65	1	1	LC1D65A●●	2.948.000	1	4.785.000	2
Koneksi Standard									
125	37	80	1	1	LC1D80●●	3.002.000	1	5.344.000	2
125	45	95	1	1	LC1D95●●	3.699.000	1	6.598.000	2
200	55	115	1	1	LC1D115●●	4.716.000	1	7.872.000	2
200	75	150	1	1	LC1D150●●	6.954.000	1	10.702.000	2

Catatan :

- Gantikan kode ●● pada referensi untuk tegangan kontrol koil sesuai dengan tabel.
- Alternatif tegangan koil DC dapat menggunakan TeSys D Green ([lihat halaman 8-10](#))
- Harga di atas hanya berlaku untuk koil M7 (220 VAC) dan BD (24 VDC)

Koil	220 V AC	24 V DC
Kode ●●	M7	BD

- Untuk tipe tegangan koil lainnya, silakan hubungi Customer Care Center kami.
- Berikut adalah kode koil untuk tegangan lain. **Harga dapat berbeda** dari yang tertera di atas

Tegangan AC (Volts)	24	48	110	230	380
Kode Koil	B7	E7	F7	P7	Q7
Tegangan DC (Volts)	12	48	110	125	220
Kode Koil	JD	ED	FD	GD	MD



Scan untuk
Data Teknis



LC1D09●●



LC1D40A●●



LC1D80A●●

TeSys Control TeSys Dega Green

Kontaktor 3 kutub dari 9A sampai dengan 65A

■ Koil elektronik yang inovatif - AC/DC

AC-1 (A)	AC-3 380/415 V		Kontak Bantu		Referensi	Harga (Rp) (Sebelum PPN)	SS
	(kW)	(A)	N/O	N/C			
Koneksi Standard							
25	4	9	1	1	LC1D09●●	1.051.000	2
25	5,5	12	1	1	LC1D12●●	1.122.000	2
32	7,5	18	1	1	LC1D18●●	1.666.000	2
40	11	25	1	1	LC1D25●●	2.028.000	2
50	15	32	1	1	LC1D32●●	3.019.000	2
50	18,5	38	1	1	LC1D38●●	3.151.000	2

Koneksi EverLink							
60	18,5	40	1	1	LC1D40A●●	4.169.000	2
80	22	50	1	1	LC1D50A●●	4.406.000	2
80	30	65	1	1	LC1D65A●●	4.772.000	2
125	37	80	1	1	LC1D80A●●	5.327.000	2

Catatan :

Gantikan kode ●● pada referensi untuk tegangan kontrol koil sesuai dengan tabel dibawah.

Koil	24-60 V	48-130 V	110-250 V
Kode ●●	BNE	EHE	KUE



Scan untuk
Data Teknis



LC1E06●●●●●●



LC1E25●●●●●●



LC1E40●●●●●●



LC1E80●●●●●●

TeSys Control

Easy TeSys

Kontaktor 4 kutub dari 16A sampai dengan 125A

■ Kontrol AC

Arus AC-1 (A)	Jumlah Kutub		Kontak Bantu		Referensi	Harga (Rp) (Sebelum PPN)	SS
	N/O	N/C	N/O	N/C			
Koneksi Standard							
16	4	-	-	-	LC1E06004M7	448.000	2
20	4	-	-	-	LC1E09004M7	460.000	2
	2	2	-	-	LC1E09008M7	460.000	2
25	4	-	-	-	LC1E12004M7	468.000	2
	2	2	-	-	LC1E12008M7	468.000	2
32	4	-	-	-	LC1E18004M7	629.000	2
	2	2	-	-	LC1E18008M7	629.000	2
40	4	-	-	-	LC1E25004M7	651.000	2
	2	2	-	-	LC1E25008M7	716.000	2
45	4	-	-	-	LC1E32004M7	863.000	2
60	4	-	-	-	LC1E38004M7	1.230.000	2
	2	2	-	-	LC1E38008M7	1.230.000	2
60	4	-	-	-	LC1E40004M7	1.450.000	2
	2	2	-	-	LC1E40008M7	1.450.000	2
80	4	-	-	-	LC1E65004M7	1.856.000	2
	2	2	-	-	LC1E65008M7	1.856.000	2
100	4	-	-	-	LC1E80004M7	2.602.000	2
125	4	-	-	-	LC1E95004M7	2.769.000	2

Catatan :

- Coil M7 ataupun M5 adalah untuk aplikasi pada 220 V AC.
- Untuk tipe tegangan coil lainnya silakan hubungi Customer Care Center kami.
- Berikut adalah kode coil untuk tegangan lain. **Harga dapat berbeda** dari yang tertera di atas.

Tegangan AC (Volts)	24	48	110	230	380
Kode Koil (50/60 Hz)	B7	E7	F7	P7	Q7



Scan untuk
Data Teknis



LC1DT20 ●●



LC1DT80A ●●



LC1D65008 ●●

TeSys Control

TeSys Deca

Kontaktor 4 kutub dari 20A sampai dengan 125A (AC-1)

■ TeSys D 4-Pole

AC-1 (A)	Jumlah Kutub		Kontak Bantu		Koil 220 V AC			Koil 24 V DC		
	N/O	N/C	N/O	N/C	Referensi	Harga (Rp) (Sebelum PPN)	SS	Referensi	Harga (Rp) (Sebelum PPN)	SS
TeSys D Koneksi Standard										
20	4	-	1	1	LC1DT20M7	680.000	2	LC1DT20BD	1.537.000	2
	2	2	1	1	LC1D098M7	680.000	1	LC1D098BD	1.537.000	2
25	4	-	1	1	LC1DT25M7	845.000	2	LC1DT25BD	2.081.000	2
	2	2	1	1	LC1D128M7	845.000	2	LC1D128BD	2.081.000	2
32	4	-	1	1	LC1DT32M7	1.132.000	2	LC1DT32BD	3.083.000	2
	2	2	1	1	LC1D188M7	1.132.000	1	LC1D188BD	3.078.000	2
40	4	-	1	1	LC1DT40M7	1.798.000	1	LC1DT40BD	3.557.000	2
	2	2	1	1	LC1D258M7	1.798.000	1	LC1D258BD	3.560.000	2
TeSys D Koneksi EverLink										
60	4	-	1	1	LC1DT60AM7	3.067.000	1	LC1DT60ABD	5.537.000	2
80	4	-	1	1	LC1DT80AM7	4.224.000	1	LC1DT80ABD	5.835.000	2
TeSys D Koneksi Standard										
60	2	2	-	-	LC1D40008M7	2.663.000	1			
80	2	2	-	-	LC1D65008M7	4.220.000	2			
125	4	-	-	-	LC1D80004M7	5.409.000	1			
125	2	2	-	-	LC1D80008M7	5.409.000	2			

Catatan :

- Untuk tipe tegangan koil lainnya silakan hubungi Customer Care Center kami.
- Berikut adalah kode koil untuk tegangan lain. **Harga dapat berbeda** dari yang tertera di atas.

Tegangan <u>AC</u> (Volts)	24	48	110	230	380
Kode Koil	B7	E7	F7	P7	Q7

Tegangan <u>DC</u> (Volts)	12	48	110	125	220
Kode Koil	JD	ED	FD	GD	MD



Scan untuk
Data Teknis



LA1KN20



LADN11



LADT2

TeSys Control

Aksesori Kontaktor TeSys Control - K dan Deca

■ Kontak Bantu Seketika

Deskripsi	Jumlah Kontak	N/O	N/C	Referensi	Harga (Rp) (Sebelum PPN)	SS	
Untuk kontaktor TeSys K	2	2	-	LA1KN20	123.000	2	
		-	2	LA1KN02	123.000	2	
	4	1	1	LA1KN11	123.000	2	
		4	-	LA1KN40	194.000	2	
		3	1	LA1KN31	194.000	2	
		2	2	LA1KN22	194.000	1	
		1	3	LA1KN13	202.000	2	
		-	4	LA1KN04	194.000	2	
	Untuk kontaktor TeSys Deca mounting depan	2	1	1	LADN11	165.000	1
			2	-	LADN20	165.000	1
4		-	2	LADN02	165.000	1	
		2	2	LADN22	294.000	1	
		1	3	LADN13	292.000	2	
		4	-	LADN40	292.000	1	
		-	4	LADN04	292.000	1	
		3	1	LADN31	292.000	1	
Untuk kontaktor TeSys Deca (koil AC) mounting samping		2	1	1	LAD8N11	231.000	1
			2	-	LAD8N20	229.000	2
	-		2	LAD8N02	232.000	2	

■ Kontak Blok Tunda Waktu

Tipe	Setting Waktu	Referensi	Harga (Rp) (Sebelum PPN)	SS
Tunda hidup	0.3 s/d 3 s	LADT0 ⁽¹⁾	1.304.000	1
	1 s/d 30 s	LADT2 ⁽¹⁾	1.304.000	1
	10 s/d 180 s	LADT4	1.304.000	2
	1 s/d 30 s	LADS2	1.304.000	1
Tunda mati	0.3 s/d 3 s	LADR0 ⁽²⁾	1.304.000	2
	1 s/d 30 s	LADR2	1.304.000	2
	10 s/d 180 s	LADR4	1.304.000	2

Catatan :

⁽¹⁾ dengan penambahan skala waktu dari 0.1 hingga 0.6 detik

⁽²⁾ dengan waktu peralihan (switching time) 40ms + 15ms di antara terbukanya kontak N/C dan tertutupnya kontak N/C

■ Koil Cadangan AC Untuk Kontaktor 3 Atau 4 Kutub

Untuk Tipe Kontraktor	110 V	220 V	Harga (Rp) (Sebelum PPN)	SS
LC1D09●● s/d LC1D38●● LC1DT20●● s/d LC1DT40●●	LXD1F7	LXD1M7	502.000	2
LC1D40A●● s/d LC1D65A●● LC1DT60A●● s/d LC1DT80A●●	LXD3F7	LXD3M7	998.000	2
LC1D80●● s/d LC1D95●●	LX1D6F5	LX1D6M5	1.333.000	2

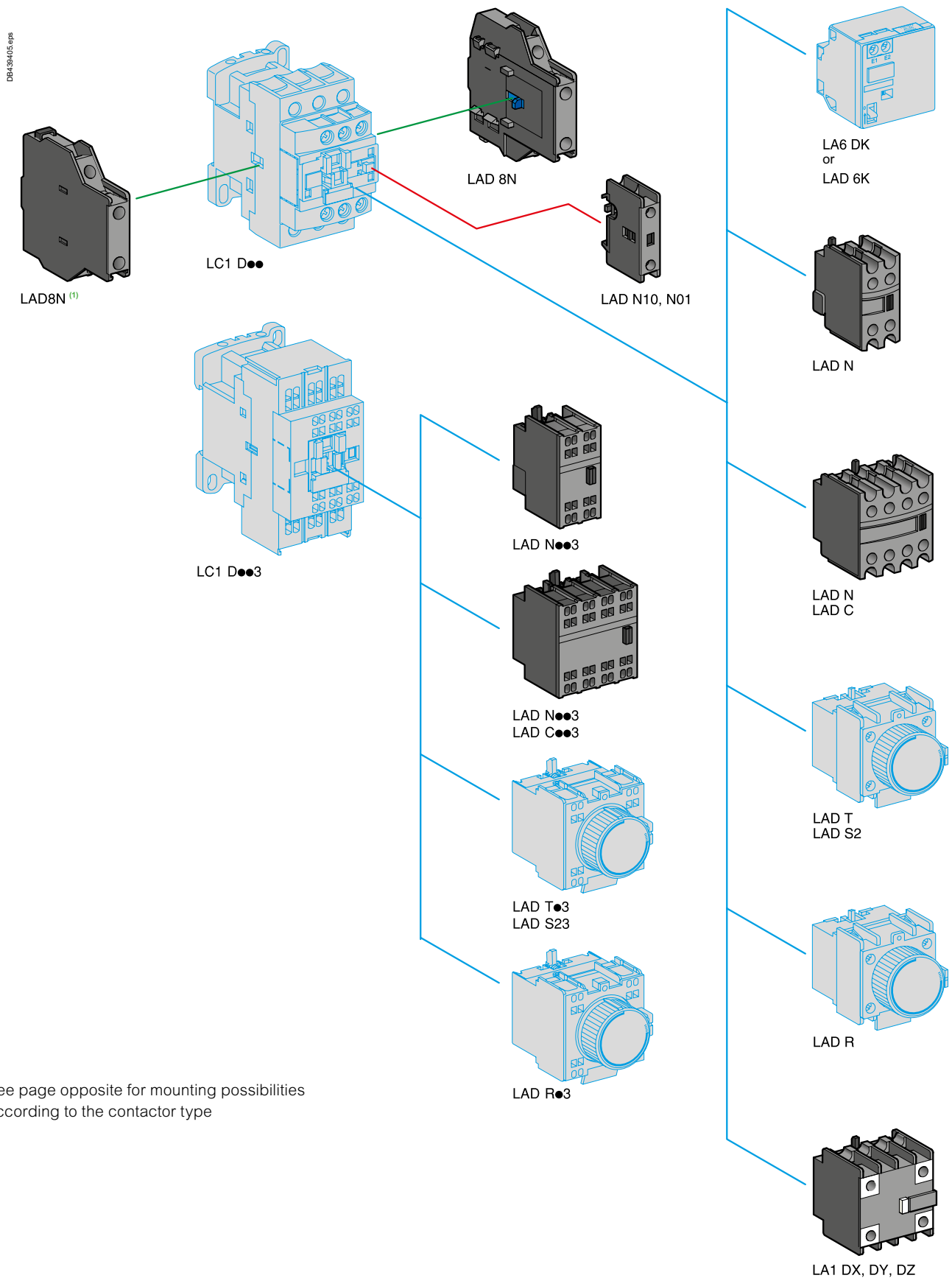

See page opposite for mounting possibilities according to the contactor type

⁽¹⁾ No left side mounting on Deca green contactors.



GV2AF3



GV3S



LAD9R1V



LAD9R3

TeSys Control

Aksesori Wiring Kit TeSys Deca

Motor Starter Wiring Kit

Fungsi	Digunakan pada	Referensi	Harga (Rp) <i>(Sebelum PPN)</i>	SS
Wiring Kit				
Memudahkan koneksi antara Motor Circuit Breaker dengan kontaktor tanpa menggunakan kabel	Motor CB tipe GV2 dengan kontaktor LC1D09●● s/d LC1D38●●	GV2AF3	78.000	1
	Motor CB tipe GV3 dengan kontaktor LC1D40A●● s/d LC1D65●● (spare part)	LAD96560	220.000	1
S - Busbar				
Mengkoneksikan Motor Circuit Breaker dengan kontaktor secara horizontal	Motor CB tipe GV3 dengan kontaktor LC1D40A●● s/d LC1D65●●	GV3S	1.470.000	2
Reverser Kit				
Memudahkan koneksi antara 2 (dua) buah kontaktor yang sama untuk mendapatkan starter reverse (2 arah) tanpa menggunakan kabel	Kontaktur LC1D09●● s/d LC1D38●●	LAD9R1V	629.000	1
	Kontaktur LC1D40A●● s/d LC1D65A●●	LAD9R3	1.697.000	2
Star Delta Kit (dengan alat tunda waktu LADS2)				
Memudahkan koneksi antara 3 (tiga) buah kontaktor yang sama untuk mendapatkan starter star delta tanpa menggunakan kabel <i>(SUDAH termasuk alat tunda waktu LADS2)</i>	Kontaktur LC1D09●● s/d LC1D12●●	LAD91217	3.004.000	2
	Kontaktur LC1D18●● s/d LC1D38●●	LAD93217	3.004.000	2
	Kontaktur LC1D40A●● s/d LC1D65A●●	LAD9SD3	4.679.000	2
Star Delta Kit (tanpa alat tunda waktu LADS2)				
Memudahkan koneksi antara 3 (tiga) buah kontaktor yang sama untuk mendapatkan starter star delta tanpa menggunakan kabel <i>(BELUM termasuk alat tunda waktu LADS2)</i>	Kontaktur LC1D09●● s/d LC1D12●●	LAD91218	1.115.000	2
	Kontaktur LC1D18●● s/d LC1D38●●	LAD93218	1.590.000	2

TeSys Giga

Kontaktor dan Relay Beban Lebih Elektronik Generasi Terbaru



TeSys Control - Kontaktor Giga

- Generasi terbaru kontaktor untuk daya tinggi 115 - 800 A (AC-3).
- Dengan referensi produk yang lebih ringkas, memudahkan pemilihan dan inventaris.
- Khusus didesain untuk aplikasi yang menantang.
- Ukuran lebar dan kedalaman yang diselaraskan dengan relay beban lebih dan breaker untuk pemasangan yang lebih mudah.
- Desain kerangka yang ramping memberikan ruang lebih dalam panel.
- Koil yang dirancang untuk konsumsi energi yang lebih hemat dan rentang tegangan yang lebih lebar.
- Diagnosa penggunaan kontak yang canggih untuk memprediksi keperluan perawatan.
- Desain modular untuk perawatan yang lebih mudah dan waktu henti yang lebih singkat.
- Tersedia dalam dua varian: **Standard** dan **Advanced**.

TeSys Protect - Relay Beban Lebih Elektronik Giga

- Generasi terbaru Relay Beban Lebih Elektronik 28 - 630 A
- Kompatibel dengan kontaktor Giga
- Rentang pengaturan yang lebih lebar dilengkapi dengan proteksi yang canggih
- Pemantauan yang berkelanjutan dilengkapi dengan indikator kesehatan unit dan juga alarm.
- Dengan referensi produk yang lebih ringkas, memudahkan pemilihan dan inventaris

LEBIH ANDAL HINGGA

90%

berkat desain modular dan rentang koil yang lebih lebar

LEBIH CEPAT HINGGA

50%

dalam proses penintegrasian

HEMAT HINGGA

40%

penggunaan ruang dalam panel

■ Penamaan Referensi TeSys Giga

> TeSys Giga Contactors

Contoh: LC1G1854EHEN

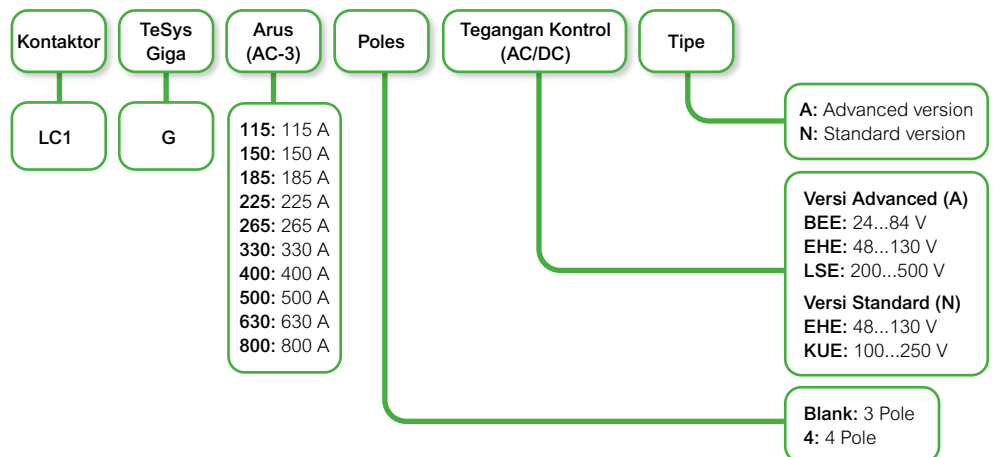

> TeSys Giga Electronic Overload Relays

Contoh: LR9G630

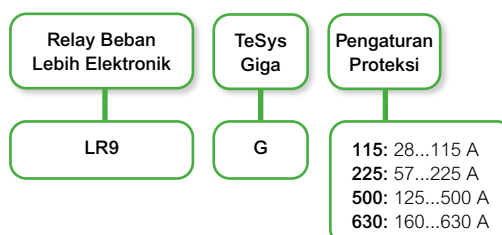



Scan untuk
Data Teknis



LC1G115KUEN



LC1G1154KUEN

TeSys Control

TeSys Giga

Kontaktor 3 & 4 Kutub dari 115A hingga 800A Tipe Standard

■ Kontaktor TeSys Giga Tipe Standard - 3 Kutub

AC-1	AC-3		AC-4	Referensi (*)	Harga (Rp) (Sebelum PPN)	SS
Arus (A)	Arus (A)	Daya Motor @400V (kW)	Daya Motor @400V (kW)			
250	115	55	55	LC1G115KUEN	8.342.000	1
275	150	75	75	LC1G150KUEN	9.715.000	2
305	185	90	90	LC1G185KUEN	11.105.000	1
330	225	110	110	LC1G225KUEN	12.770.000	1
385	265	132	132	LC1G265KUEN	16.644.000	2
440	330	160	160	LC1G330KUEN	27.161.000	2
550	400	200	200	LC1G400KUEN	34.432.000	2
700	500	250	250	LC1G500KUEN	41.688.000	2
1050	630	335	315	LC1G630KUEN	43.887.000	2
1050	800	450	375	LC1G800KUEN	62.332.000	2

*) Untuk tegangan koil selain 100 - 250 V, gantikan kode koil KUEN dengan pilihan koil di bawah ini:

Koil AC/DC	48 - 130 V	100 - 250 V
Kode ●●	EHEN	KUEN

■ Kontaktor TeSys Giga Tipe Standard - 4 Kutub

Aplikasi Load Control (non-motor)

AC-1	Referensi (*)	Harga (Rp) (Sebelum PPN)	SS
Arus Maksimum (A)			
250	LC1G1154KUEN	14.237.000	2
275	LC1G1504KUEN	14.483.000	2
305	LC1G1854KUEN	16.856.000	2
330	LC1G2254KUEN	18.723.000	2
385	LC1G2654KUEN	22.136.000	2
440	LC1G3304KUEN	30.030.000	2
550	LC1G4004KUEN	36.719.000	2
700	LC1G5004KUEN	43.950.000	2
1050	LC1G6304KUEN	53.953.000	2
1050	LC1G8004KUEN	69.012.000	2

*) Untuk tegangan koil selain 100 - 250 V, gantikan kode koil KUEN dengan pilihan koil di bawah ini:

Koil AC/DC	48 - 130 V	100 - 250 V
Kode ●●	EHEN	KUEN



Scan untuk
Data Teknis



LC1G115KUEN



LC1G1154KUEN

TeSys Control

TeSys Giga

Kontaktor 3 & 4 Kutub dari 115 A hingga 800 A Tipe Advanced

■ Kontaktor TeSys Giga Tipe Advanced - 3 Kutub

AC-1	AC-3		AC-4	Referensi (*)	Harga (Rp) (Sebelum PPN)	SS
Arus (A)	Arus (A)	Daya Motor @400V (kW)	Daya Motor @400V (kW)			
250	115	55	55	LC1G115LSEA	9.136.000	2
275	150	75	75	LC1G150LSEA	10.640.000	2
305	185	90	90	LC1G185LSEA	12.163.000	2
330	225	110	110	LC1G225LSEA	13.986.000	2
385	265	132	132	LC1G265LSEA	18.229.000	2
440	330	160	160	LC1G330LSEA	29.748.000	2
550	400	200	200	LC1G400LSEA	37.711.000	2
700	500	250	250	LC1G500LSEA	45.660.000	2
1050	630	335	315	LC1G630LSEA	47.604.000	2
1050	800	450	375	LC1G800LSEA	68.565.000	2

*) Untuk tegangan koil selain 200 - 500 V, gantikan kode koil LSEA dengan pilihan koil di bawah ini:

Koil AC/DC	24 - 48 V	48 - 130 V	200 - 500 V
Kode ●●	BEEA	EHEA	LSEA

■ Kontaktor TeSys Giga Tipe Advanced - 4 Kutub

Aplikasi Load Control (non-motor)

AC-1	Referensi (*)	Harga (Rp) (Sebelum PPN)	SS
Arus Maksimum (A)			
250	LC1G1154LSEA	15.594.000	2
275	LC1G1504LSEA	15.865.000	2
305	LC1G1854LSEA	18.464.000	2
330	LC1G2254LSEA	20.506.000	2
385	LC1G2654LSEA	24.244.000	2
440	LC1G3304LSEA	32.891.000	2
550	LC1G4004LSEA	40.216.000	2
700	LC1G5004LSEA	48.136.000	2
1050	LC1G6304LSEA	59.091.000	2
1050	LC1G8004LSEA	75.915.000	2

*) Untuk tegangan koil selain 200 - 500 V, gantikan kode koil LSEA dengan pilihan koil di bawah ini:

Koil AC/DC	24 - 48 V	48 - 130 V	200 - 500 V
Kode ●●	BEEA	EHEA	LSEA



Scan untuk
Data Teknis



LR9G225



LAG8N113

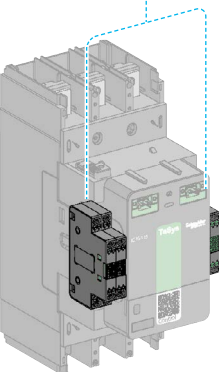

Pemasangan di samping kontaktor,
maksimum 2 auxiliary contact
di masing-masing sisi

TeSys Protect

LR9G

Relay Beban Lebih Elektronik TeSys Giga

■ Relay Beban Lebih Elektronik untuk Kontaktor TeSys Giga

Setting Arus (A) Kelas 5...30 A	Untuk kontaktor TeSys Giga	Referensi	Harga (Rp) (Sebelum PPN)	SS
28 - 115	LC1G115...225	LR9G115	7.743.000	2
57 - 225	LC1G115...225	LR9G225	7.900.000	1
125 - 500	LC1G265...500	LR9G500	10.013.000	2
160 - 630	LC1G630	LR9G630	10.312.000	2

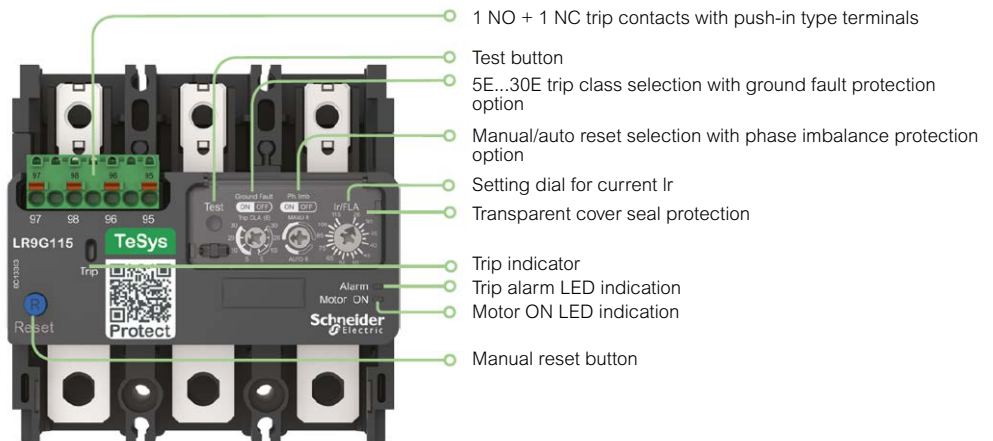

■ Aksesoris TeSys Giga

Deskripsi	Posisi	Tipe Kontak	Referensi	Harga (Rp) (Sebelum PPN)	SS
Auxiliary Contact Modules	samping kiri atau kanan pertama	1NO + 1 NC	LAG8N113P ⁽¹⁾	265.000	2
	samping kiri atau kanan kedua	2 NO	LAG8N203P	362.000	2
	samping kiri atau kanan kedua	1 NO + 1 NC	LAG8N113	265.000	2
	samping kiri atau kanan kedua	2 NO	LAG8N203	362.000	2

(1) Selalu disertakan dengan kontaktor TeSys Giga LC1G, dipasang pada permukaan lateral sisi kanan.

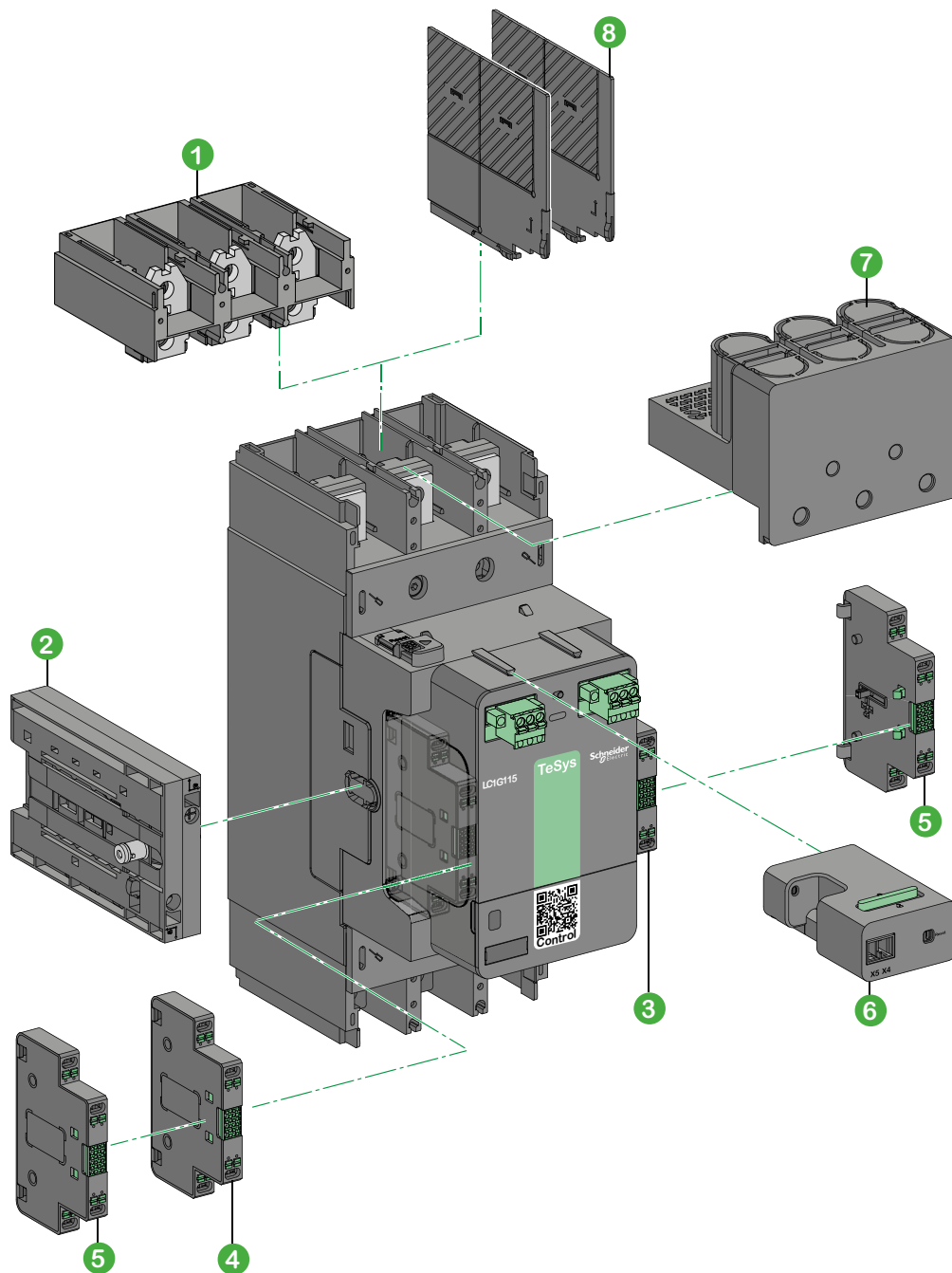

- ① Cable memory kit **LA9G3102**, is always supplied along with Advanced version, and it's an optional accessory for Standard version.
- ② Mechanical interlock **LA9G970**, can be installed on either side of the contactor.
- ③ Auxiliary contact module **LAG8N113P** (1 NO + 1 NC) supplied with LC1G contactor.
- ④ Auxiliary contact modules **LAG8N113P / LAG8N203P**, can be installed on the contactor lateral faces ⁽¹⁾
- ⑤ Auxiliary contact modules **LAG8N113 / LAG8N203**, can be installed on either side as 2nd set of contacts.
- ⑥ Remote Wear Diagnostic (RWD) Module **LA9GRD01 / LA9GRD10**, can be installed and used only in Advanced version.
- ⑦ IP 20 terminal shroud **LA9G3701**.
- ⑧ Phase separators **LA9G3801**, please refer to pages B9/14 to B9/18 for complete details of available accessories.

Note: a maximum of 2 auxiliary contact modules can be mounted on each side of the contactor.
(1) Does not increase the contactor dimensions when fitted on both sides.



Scan untuk
Data Teknis



LRE02



LRE355



LRE485

TeSys Protect

LRE

Relai Termal Beban Lebih Easy TeSys

■ Relay beban lebih termal untuk Easy TeSys

Setting Arus (A)	Untuk kontaktor LC1	Referensi	Harga (Rp) <i>(Sebelum PPN)</i>	SS
Koneksi Standard				
0.16 ... 0.25	E06 ... E38	LRE02	326.000	2
0.25 ... 0.40	E06 ... E38	LRE03	326.000	2
0.40 ... 0.63	E06 ... E38	LRE04	326.000	2
0.63 ... 1	E06 ... E38	LRE05	326.000	2
1 ... 1.6	E06 ... E38	LRE06	326.000	1
1.6 ... 2.5	E06 ... E38	LRE07	326.000	1
2.5 ... 4	E06 ... E38	LRE08	326.000	1
4 ... 6	E06 ... E38	LRE10	329.000	1
5.5 ... 8	E09 ... E38	LRE12	331.000	1
7 ... 10	E09 ... E38	LRE14	333.000	1
9 ... 13	E12 ... E38	LRE16	344.000	1
12 ... 18	E18 ... E38	LRE21	370.000	1
16 ... 24	E25 ... E38	LRE22	382.000	1
23 ... 32	E25 ... E38	LRE32	487.000	1
30 ... 40	E40 ... E95	LRE355	868.000	1
37 ... 50	E50 ... E95	LRE357	1.079.000	2
48 ... 65	E65 ... E95	LRE359	1.212.000	2
55...70	E80 ... E95	LRE361	1.251.000	2
80...104	E95	LRE365	2.000.000	2
84...135	E120...E160	LRE482	2.750.000	2
124...198	E200	LRE483	7.235.000	2
174...279	E250...E400	LRE485	7.235.000	2
259...414	E300 ...E400	LRE487	7.264.000	2
321 ... 513	E500	LRE488	7.311.000	2
394 ... 630	E630	LRE489	7.311.000	2



Scan untuk
Data Teknis



LR2K0307

TeSys Protect LR2K

Relay Beban Lebih Termal TeSys K

■ Relay beban lebih termal untuk kontaktor TeSys K (kelas 10A)

Setting Arus (A)	Untuk Kontaktor LC1	Referensi	Harga (Rp) <i>(Sebelum PPN)</i>	SS
0.11 ... 0.16	K06 ... K16	LR2K0301	601.000	2
0.16 ... 0.23	K06 ... K16	LR2K0302	601.000	2
0.23 ... 0.36	K06 ... K16	LR2K0303	601.000	2
0.36 ... 0.54	K06 ... K16	LR2K0304	601.000	2
0.54 ... 0.8	K06 ... K16	LR2K0305	601.000	2
0.8 ... 1.2	K06 ... K16	LR2K0306	601.000	2
1.2 ... 1.8	K06 ... K16	LR2K0307	601.000	2
1.8 ... 2.6	K06 ... K16	LR2K0308	601.000	1
2.6 ... 3.7	K06 ... K16	LR2K0310	601.000	2
3.7 ... 5.5	K06 ... K16	LR2K0312	601.000	2
5.5 ... 8	K06 ... K16	LR2K0314	601.000	2
8 ... 11.5	K06 ... K16	LR2K0316	601.000	2
10 ... 14	K06 ... K16	LR2K0321	669.000	1
12 ... 16	K06 ... K16	LR2K0322	669.000	2



Scan untuk
Data Teknis



LRD08



LRD35



LRD33●●

TeSys Protect LRD

Relay Beban Lebih Termal TeSys Deca (Kelas 10A)

Relay beban lebih termal untuk kontaktor TeSys Deca

Setting Arus (A)	Untuk kontaktor LC1	Referensi	Harga (Rp) (Sebelum PPN)	SS
Koneksi Standard				
0.10 ... 0.16	D09 ... D38	LRD01	517.000	2
0.16 ... 0.25	D09 ... D38	LRD02	517.000	2
0.25 ... 0.40	D09 ... D38	LRD03	517.000	1
0.40 ... 0.63	D09 ... D38	LRD04	517.000	1
0.63 ... 1	D09 ... D38	LRD05	517.000	1
1 ... 1.6	D09 ... D38	LRD06	517.000	1
1.6 ... 2.5	D09 ... D38	LRD07	517.000	1
2.5 ... 4	D09 ... D38	LRD08	517.000	1
4 ... 6	D09 ... D38	LRD10	517.000	1
5.5 ... 8	D09 ... D38	LRD12	517.000	1
7 ... 10	D09 ... D38	LRD14	522.000	1
9 ... 13	D12 ... D38	LRD16	522.000	1
12 ... 18	D18 ... D38	LRD21	587.000	1
16 ... 24	D25 ... D38	LRD22	605.000	1
23 ... 32	D25 ... D38	LRD32	775.000	1
30 ... 38	D32 ... D38	LRD35	793.000	1

Koneksi EverLink

9 ... 13	D40A ... D65A	LRD313	1.398.000	2
12 ... 18	D40A ... D65A	LRD318	1.398.000	1
17 ... 25	D40A ... D65A	LRD325	1.398.000	1
23 ... 32	D40A ... D65A	LRD332	1.398.000	1
30 ... 40	D40A ... D65A	LRD340	1.500.000	1
37 ... 50	D40A ... D65A	LRD350	1.603.000	1
48 ... 65	D50A ... D65A	LRD365	1.779.000	1

Koneksi Standard

55 ... 70	D80 ... D95	LRD3361	2.273.000	1
63 ... 80	D80 ... D95	LRD3363	2.316.000	1
80 ... 104	D80 ... D95	LRD3365	2.340.000	1
80 ... 104	D115 ... D150	LRD4365	3.964.000	1
95 ... 120	D115 ... D150	LRD4367	4.002.000	1
110 ... 140	D150	LRD4369	4.306.000	2

Aksesori

Setting Arus (A)	Untuk TOR dan kontaktor	Referensi	Harga (Rp) (Sebelum PPN)	SS
Terminal Block untuk mounting/kabel	LRD01 ... D35	LAD7B106	213.000	1
	LRD33●●	LA7D3064	1.186.000	2
	LRD3●●	LAD96560	220.000	1

DB438743_aps

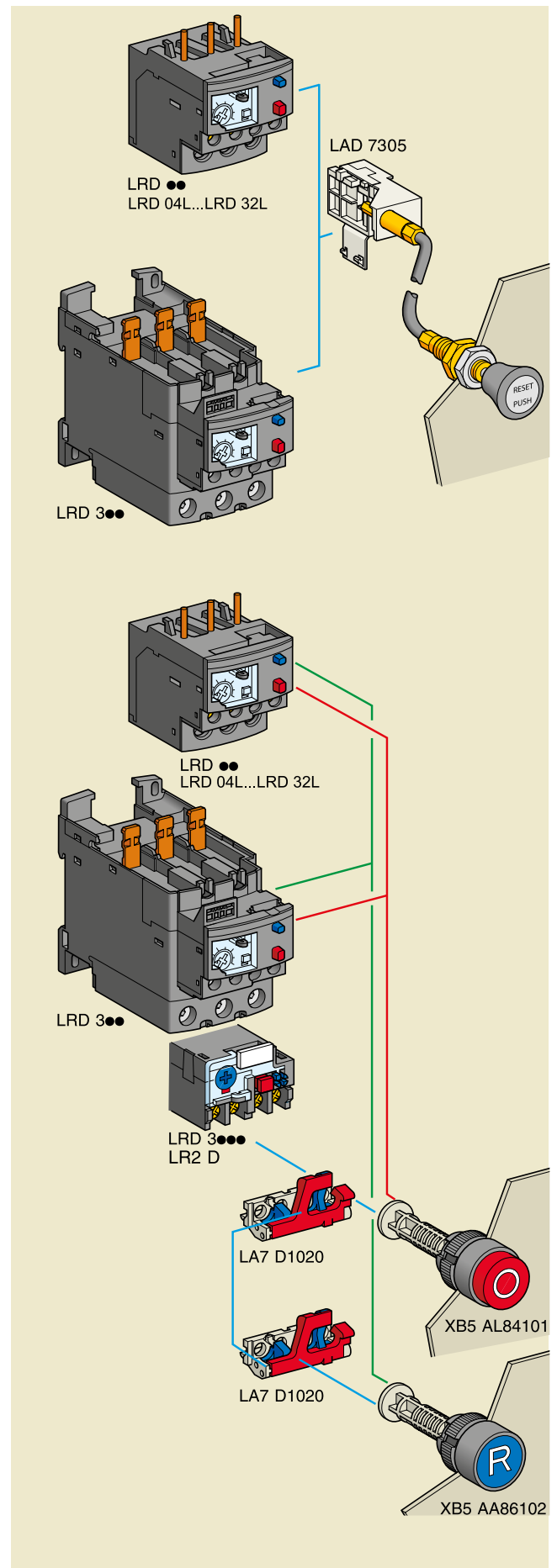
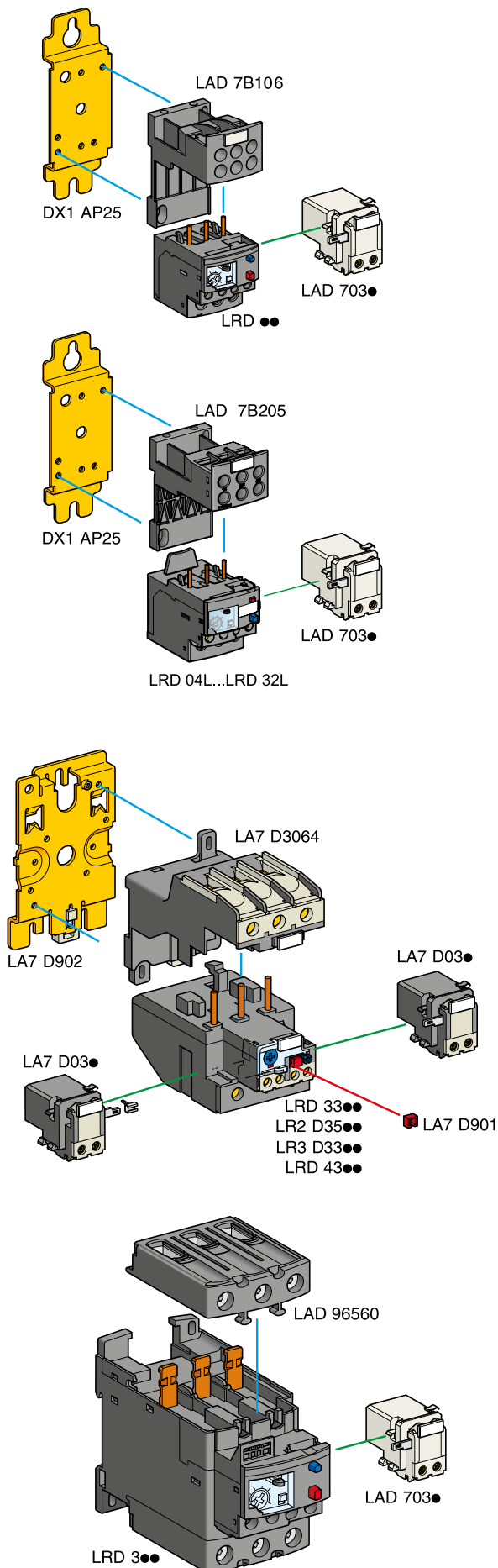



Scan untuk
Data Teknis



LR97D●●



Scan untuk
Data Teknis



LT4730●●●

TeSys Protect

LR97D & LT47

Electronic Over Current Relay (EOCR)

■ Electronic Over Current Relay (EOCR)

- Arus Proteksi Overload : 0.3A s/d 60A
- Tegangan Supply : 24 V AC/DC
- Aplikasi Relay : Locked rotor, Mechanical jamming $I > 3 \times I$ setting
Overload $I_{max} > I$ setting
Sensitif terhadap phase failure

■ EOCR LR97D

Setting Arus (A)	Untuk kontaktor LC1	Suplai Tegangan (V)	Referensi	Harga (Rp) (Sebelum PPN)	SS
0.3 ... 1.5	D09 ... D38	100 ... 120 V AC	LR97D015F7	1.712.000	2
		200 ... 240 V AC	LR97D015M7	1.712.000	2
1.2 ... 7	D09 ... D38	100 ... 120 V AC	LR97D07F7	1.712.000	2
		200 ... 240 V AC	LR97D07M7	1.712.000	2
5 ... 25	D09 ... D38	100 ... 120 V AC	LR97D25F7	1.975.000	2
		200 ... 240 V AC	LR97D25M7	1.975.000	1
20 ... 38	D25 ... D38	100 ... 120 V AC	LR97D38F7	2.091.000	2
		200 ... 240 V AC	LR97D38M7	2.220.000	2

■ EOCR LT47

Setting Arus (A)	Suplai Tegangan (V)	Referensi	Harga (Rp) (Sebelum PPN)	SS
Reset Manual				
0.5 ... 6	100 ... 120 V AC	LT4706F7S	1.739.000	2
	200 ... 240 V AC	LT4706M7S	1.739.000	1
3 ... 30	100 ... 120 V AC	LT4730F7S	1.791.000	2
	200 ... 240 V AC	LT4730M7S	1.900.000	2
5 ... 60	24 V AC/DC	LT4760BS	2.130.000	2
	48 V AC/DC	LT4760ES	2.008.000	2
	100 ... 120 V AC	LT4760F7S	2.130.000	2
	200 ... 240 V AC	LT4760M7S	2.130.000	1
Reset Otomatis				
0.5 ... 6	24 V AC/DC	LT4706BA	1.640.000	2
	200 ... 240 V AC	LT4706M7A	1.739.000	2
3 ... 30	24 V AC/DC	LT4730BA	1.900.000	2
	100 ... 120 V AC	LT4730F7A	1.900.000	2
5 ... 60	200 ... 240 V AC	LT4730M7A	1.900.000	2
	24 V AC/DC	LT4760BA	2.130.000	2
	200 ... 240 V AC	LT4760M7A	2.130.000	1



Scan untuk
Data Teknis



GV2L10

TeSys Power

Deca Size 2 & 3

Motor Circuit Breaker (Proteksi Magnetik)

■ Pedoman Pemilihan

- *Magnetic Motor Circuit Breaker* **BELUM** dilengkapi dengan fungsi proteksi beban lebih termal sehingga perlu ditambahkan relay thermal (asosiasi 3 komponen) untuk melindungi motor dari gangguan beban lebih
- Asosiasi 3 komponen memungkinkan untuk melindungi motor terutama bagi motor-motor yang memiliki karakteristik *long-start* dengan menggunakan *relay proteksi beban lebih termal* kelas 20 atau 30.

■ GV2L - Motor circuit breaker dari 0.09 hingga 15 kW

Motor 400/415 V		Rating Proteksi Magnetik (A)	Referensi	Harga (Rp) (Sebelum PPN)	SS
P (kW)	Icu (kA)				
0.09	> 100	0,4	GV2L03	960.000	2
0.12	> 100	0,63	GV2L04	960.000	2
0.18	> 100	0,63	GV2L04	960.000	2
0.25	> 100	1	GV2L05	960.000	1
0.37	> 100	1	GV2L05	960.000	1
0.55	> 100	1,6	GV2L06	960.000	2
0.75	> 100	2,5	GV2L07	960.000	2
1.1	> 100	-	GV2L08	962.000	1
1.5	> 100	4	GV2L08	962.000	1
2.2	> 100	6,3	GV2L10	974.000	1
3	> 100	10	GV2L14	1.079.000	1
4	> 100	-	GV2L14	1.079.000	1
5.5	50	14	GV2L16	1.145.000	1
7.5	50	18	GV2L20	1.371.000	1
9	50	25	GV2L22	1.397.000	1
11	50	25	GV2L22	1.397.000	1
15	50	32	GV2L32	2.218.000	2

Catatan : Indikasi posisi breaker dalam bentuk *rotary knob (on-off-trip)*.

■ GV3L - Motor circuit breaker dari 11 hingga 45 kW

Motor 400/415 V		Rating Proteksi Magnetik (A)	Referensi	Harga (Rp) (Sebelum PPN)	SS
P (kW)	Icu (kA)				
11	100	25	GV3L25	2.438.000	2
15	100	32	GV3L32	2.604.000	2
18,5	100	40	GV3L40	2.706.000	1
22	100	50	GV3L50	2.796.000	2
30	100	65	GV3L65	2.878.000	2
37	60	73	GV3L73	3.583.000	2
45	60	80	GV3L80 (*)	3.607.000	2

Catatan :

- Produk GV3L sudah dilengkapi dengan teknologi EverLink yang memudahkan instalasi dengan menyediakan sambungan langsung (tanpa Aksesori) dengan kontaktor **LC1D40A - LC1D65A**
- Indikasi posisi breaker dalam bentuk *rotary knob (on-off-trip)*
- *) Maksimum Arus untuk Lock Rotor = 750 A



Scan untuk
Data Teknis



GV3L65



Scan untuk
Data Teknis



GV2P10

TeSys Power

Deca Size 2 & 3

Motor Circuit Breaker (Proteksi Magnetik Termal)

■ GV2P - Motor circuit breaker hingga 15 kW

Motor 400/415 V		Setting Arus (A)	Referensi	Harga (Rp) (Sebelum PPN)	SS
P (kW)	Icu (kA)				
0.06	> 100	0.16 ... 0.25	GV2P02	1.173.000	2
0.09	> 100	0.25 ... 0.4	GV2P03	1.173.000	2
0.12	> 100	0.4 ... 0.63	GV2P04	1.179.000	2
0.18	> 100	0.4 ... 0.63	GV2P04	1.179.000	2
0.25	> 100	0.63 ... 1	GV2P05	1.179.000	2
0.37	> 100	1 ... 1.6	GV2P06	1.179.000	1
0.55	> 100	1 ... 1.6	GV2P06	1.179.000	1
0.75	> 100	1.6 ... 2.5	GV2P07	1.179.000	1
1.1	> 100	2.5 ... 4	GV2P08	1.179.000	2
2.2	> 100	4 ... 6.3	GV2P10	1.179.000	1
3	> 100	6 ... 10	GV2P14	1.344.000	1
5.5	> 100	9 ... 14	GV2P16	1.408.000	1
7.5	50	13 ... 18	GV2P20	1.408.000	1
9	50	17 ... 23	GV2P21	1.604.000	2
11	50	20 ... 25	GV2P22	1.683.000	1
15	50	24 ... 32	GV2P32	2.457.000	1

Catatan : Indikasi posisi breaker dalam bentuk *rotary knob (on-off-trip)*.

■ GV3P - Motor circuit breaker hingga 45 kW

Motor 400/415 V		Setting Arus (A)	Referensi	Harga (Rp) (Sebelum PPN)	SS
P (kW)	Icu (kA)				
5,5	100	9 ... 13	GV3P13	2.817.000	2
7,5	100	12 ... 18	GV3P18	2.817.000	2
11	100	17 ... 25	GV3P25	2.817.000	2
15	100	23 ... 32	GV3P32	2.927.000	1
18,5	50	30 ... 40	GV3P40	2.927.000	1
22	50	37 ... 50	GV3P50	3.086.000	1
30	50	48 ... 65	GV3P65	3.229.000	1
37	50	62 ... 73	GV3P73	3.876.000	1
45	50	70 ... 80	GV3P80 (*)	4.053.000	1

Catatan :

- Produk GV3P sudah dilengkapi dengan teknologi EverLink yang memudahkan instalasi dengan menyediakan sambungan langsung (tanpa Aksesori) dengan kontaktor LC1D40A - LC1D65A
- Indikasi posisi breaker dalam bentuk *rotary knob (on-off-trip)*
- *) Untuk aplikasi dengan beban arus maksimum 80 A yang stabil dan arus maksimum Lock Rotor 750 A.



Scan untuk
Data Teknis



GV3P65



Scan untuk
Data Teknis



GV2ME10

TeSys Power

Deca Size 2

Motor Circuit Breaker (Proteksi Magnetik Termal) & Aksesoris

■ Pedoman Pemilihan

■ *Thermal Magnetic Motor Circuit Breaker* **SUDAH** dilengkapi dengan fungsi proteksi *relay beban lebih termal* kelas 10 yang memungkinkan untuk melindungi motor dari gangguan beban lebih tanpa memerlukan tambahan komponen relay thermal (cukup asosiasi 2 ko ponen saja sehingga memberikan keuntungan berupa:

■ **LEBIH HEMAT BIAYA**

■ **LEBIH SEDIKIT PRODUK** yang memerlukan maintenance, serta

■ **LEBIH HEMAT TEMPAT** sehingga memerlukan dimensi panel yang lebih kecil.

■ Gunakan produk GV2P atau GV3P untuk mendapatkan unjuk kerja yang lebih tinggi, dengan kapasitas pemutusan (*Icu*) yang lebih tinggi pula.

■ GV2ME Motor circuit breaker push button hingga 15 kW

Motor 400/415 V		Setting Arus (A)	Referensi	Harga (Rp) (Sebelum PPN)	SS
P (kW)	Icu (kA)				
0,06	> 100	0.16 ... 0.25	GV2ME02	844.000	2
0,09	> 100	0.25 ... 0.4	GV2ME03	844.000	2
0,12	> 100	0.4 ... 0.63	GV2ME04	844.000	1
0,18	> 100	0.4 ... 0.63	GV2ME04	844.000	1
0,25	> 100	0.63 ... 1	GV2ME05	844.000	1
0,37	> 100	1 ... 1.6	GV2ME06	844.000	1
0,55	> 100	1 ... 1.6	GV2ME06	844.000	1
0,75	> 100	1.6 ... 2.5	GV2ME07	844.000	1
1,1	> 100	2.5 ... 4	GV2ME08	844.000	1
1,5	> 100	2.5 ... 4	GV2ME08	844.000	1
2,2	> 100	4 ... 6.3	GV2ME10	844.000	1
3	> 100	6 ... 10	GV2ME14	960.000	1
4	> 100	6 ... 10	GV2ME14	960.000	1
5,5	15	9 ... 14	GV2ME16	1.017.000	1
7,5	15	13 ... 18	GV2ME20	1.017.000	1
9	15	17 ... 23	GV2ME21	1.267.000	1
11	15	20 ... 25	GV2ME22	1.323.000	1
15	10	24 ... 32	GV2ME32	1.976.000	1

Catatan : Indikasi posisi *breaker* dalam bentuk *push button*

■ Aksesori Motor Circuit Breaker GV2 & GV3

Kontak Bantu Tambahan

Deskripsi	Pemasangan	Kontak	Referensi	Harga (Rp) (Sebelum PPN)	SS	
Kontak bantu	Depan	GV2 & GV3	N/O + N/C	GVAE11	195.000	1
			N/O + N/O	GVAE20	195.000	2
	Samping	GV2 & GV3	N/O + N/C	GVAN11	242.000	1
			N/O + N/O	GVAN20	242.000	2
Fault signalling + Kontak bantu	Samping	GV2 & GV3	N/O (fault) + N/O	GVAD1010	360.000	1
			N/O (fault) + N/C	GVAD1001	362.000	1
			N/C (fault) + N/O	GVAD0110	362.000	1
		GV3	N/C (fault) + N/C	GVAD0101	360.000	2
			N/C	GV3A08	493.000	2
			N/O	GV3A09	493.000	2
Hubung singkat 100 kA limiter	Samping	GV2	C/O	GVAM11	326.000	2
	Di atas	GV2	C/O	GV1L3	1.576.000	2



GVAE11



GVAN11

D943407.eps

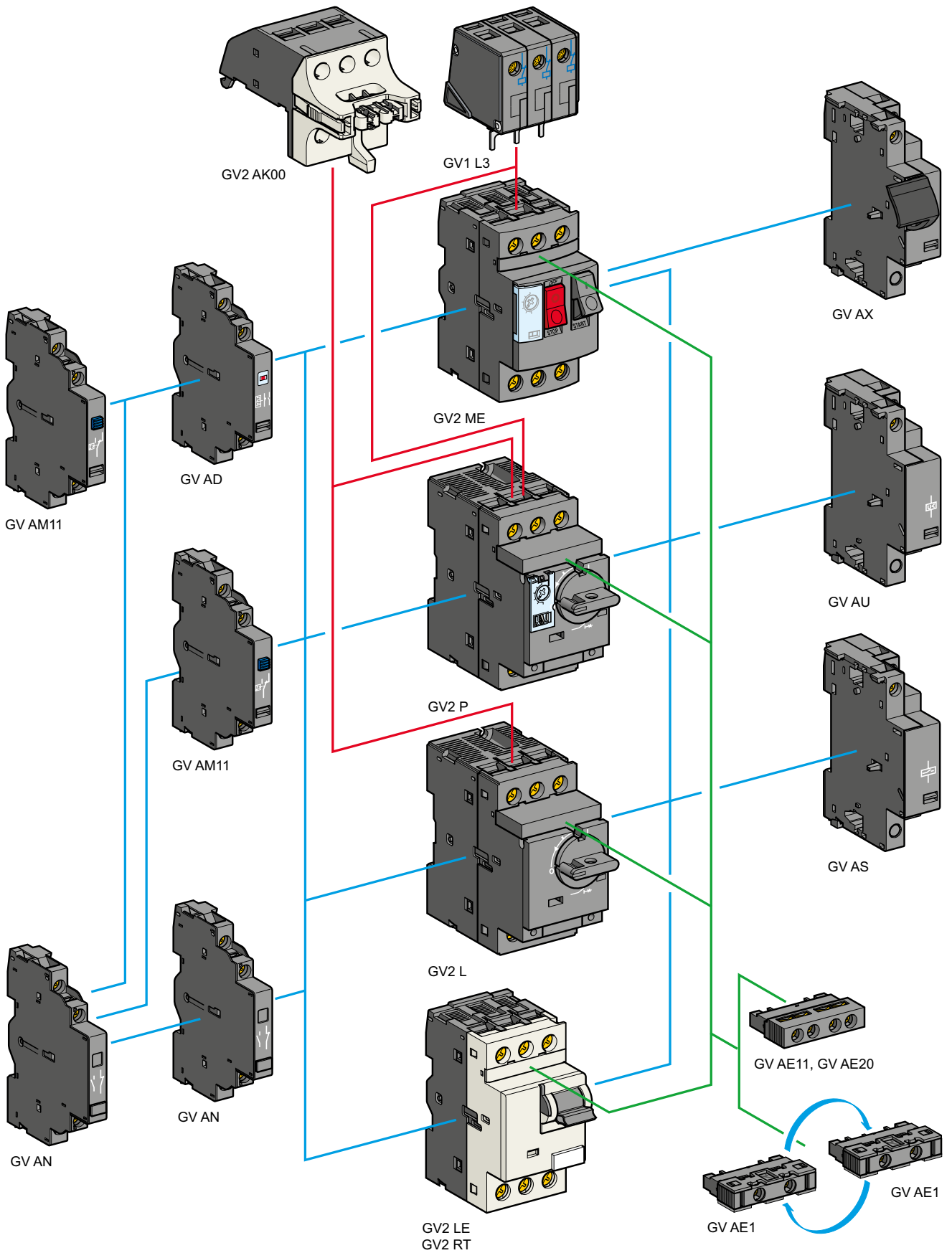

DB126629-eps

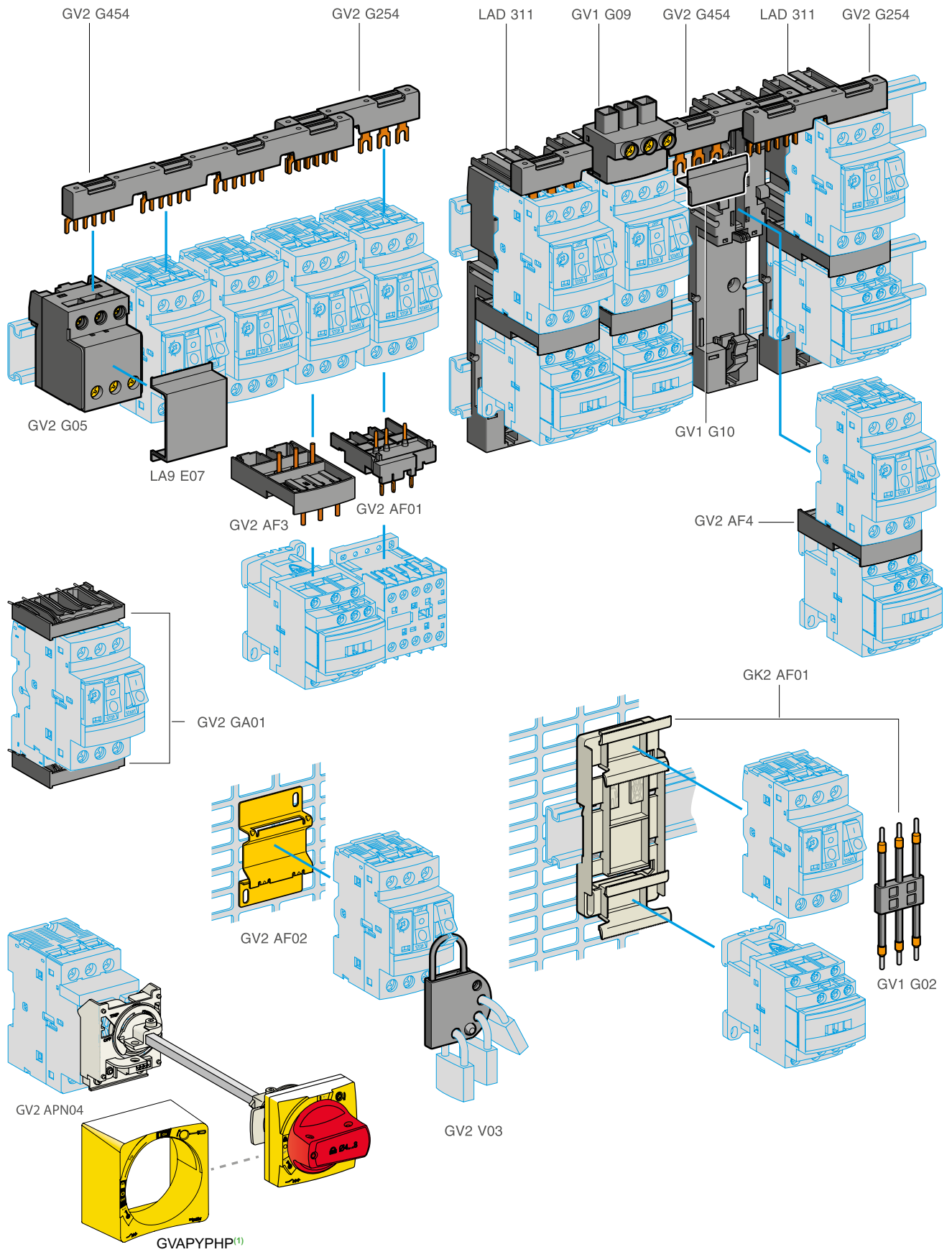

⁽¹⁾ Standard front plate must be removed from the assembly and replaced by Protective front plate (GVAPYPHP).

DB439403.eps

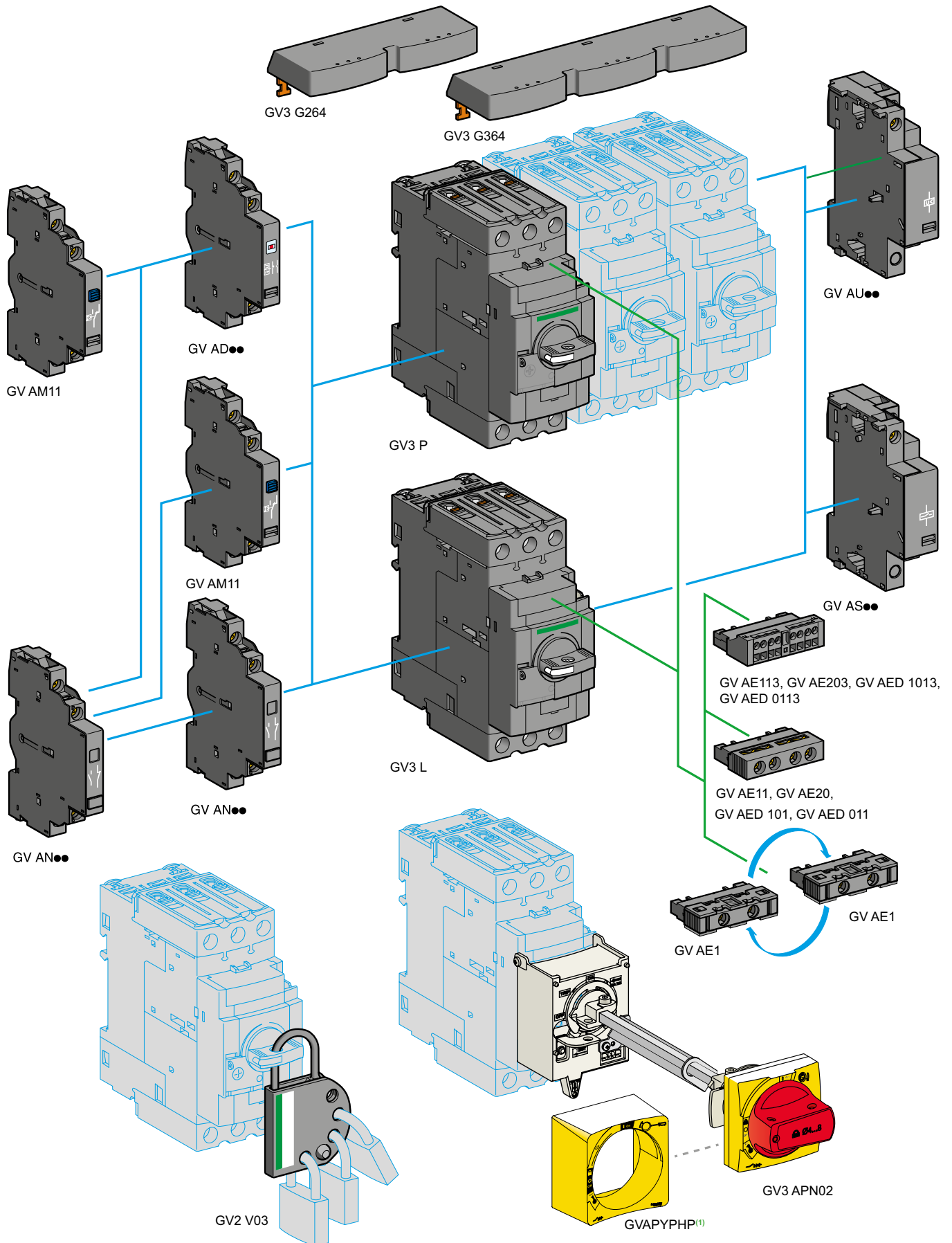

(1) Standard front plate must be removed from the assembly and replaced by Protective front plate (GVAPYPHP).



Scan untuk
Data Teknis



GV4LE80N



GV4L80N



GV4ADN01

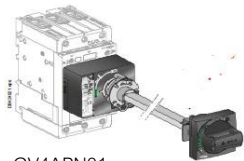

GV4APN01

TeSys Power

Deca Size 4

Motor Circuit Breaker (Proteksi Magnetik)

■ GV4L Motor circuit breaker dari 0.25 hingga 55 kW

- *Magnetic Motor Circuit Breaker* **BELUM** dilengkapi dengan fungsi proteksi Relay thermal sehingga perlu ditambahkan Relay thermal (asosiasi 3 komponen) untuk melindungi motor dari gangguan beban lebih.
- Asosiasi 3 komponen memungkinkan untuk melindungi motor terutama bagi motor-motor yang memiliki karakteristik *long-start* dengan menggunakan Relay thermal kelas 20 atau 30.

Motor 400/415 V		Setting Arus Magnetik		Referensi Toggle	Referensi Rotary	Harga (Rp) (Sebelum PPN)	SS
P (kW)	Icu (kA)	li (A)					
0.25...0.75	50	12 ... 28		GV4LE02N	GV4L02N	3.346.000	2
	100			GV4LE02S	-	3.518.000	2
0.55...1.5	50	21 ... 49		GV4LE03N	GV4L03N	3.346.000	2
	100			GV4LE03S	-	3.518.000	2
1.5... 3	50	42 ... 98		GV4LE07N	GV4L07N	3.346.000	2
	100			GV4LE07S	-	3.518.000	2
3... 5.5	50	75 ... 175		GV4LE12N	GV4L12N	3.346.000	2
	100			GV4LE12S	-	3.518.000	2
5.5... 11	50	150 ... 350		GV4LE25N	GV4L25N	3.346.000	2
	100			GV4LE25S	-	3.518.000	2
11... 22	50	300 ... 700		GV4LE50N	GV4L50N	3.493.000	2
	100			GV4LE50S	-	3.666.000	2
18.5... 37	50	480 ... 1120		GV4LE80N	GV4L80N	3.493.000	2
	100			GV4LE80S	GV4L80S	3.666.000	2
30... 55	50	690 ... 1610		GV4LE115N	GV4L115N	3.992.000	2
	100			GV4LE115S	GV4L115S	4.162.000	2

■ Rotary Handle

- Tetap Menjaga indikasi 3 posisi: O (OFF), I (ON), dan trip
- Fungsi isolasi tetap terjaga
- Circuit breaker dapat dikunci dalam posisi OFF

Rotary Handle	Referensi	Harga (Rp) (Sebelum PPN)	SS
Black rotary handle	GV4ADN01	1.002.000	2
Extended Rotary Handle	GV4APN01	1.303.000	2



Scan untuk
Data Teknis



GV4PE80N



GV4P80N

TeSys Power

Deca Size 4

Motor Circuit Breaker (Proteksi Termal Magnetik)

■ GV4P Motor circuit breaker dari 0.25 hingga 55 kW

■ *Thermal Magnetic Motor Circuit Breaker* **SUDAH** dilengkapi dengan fungsi proteksi *relay thermal* kelas 10 yang memungkinkan untuk melindungi motor dari gangguan beban lebih tanpa memerlukan tambahan komponen *relay thermal* (cukup asosiasi 2 komponen saja) sehingga memberikan keuntungan berupa:

- **LEBIH HEMAT BIAYA.**
 - **LEBIH SEDIKIT PRODUK** yang memerlukan *maintenance*.
 - **LEBIH HEMAT TEMPAT** sehingga memerlukan dimensi panel yang lebih kecil.
- Gunakan produk GV4P untuk mendapatkan unjuk kerja yang lebih tinggi, dengan kapasitas pemutusan (Icu) yang lebih tinggi pula.

Motor 400/415 V		Setting Arus Magnetik		Referensi Toggle	Referensi Rotary	Harga (Rp) (Sebelum PPN)	SS
P (kW)	Icu (kA)	Ir (A)					
0.25...0.75	50	0.8 ... 2		GV4PE02N	GV4P02N	8.331.000	2
	100			GV4PE02S	-	8.514.000	2
0.55...1.5	50	1.4 ... 3.5		GV4PE03N	GV4P03N	8.331.000	2
	100			GV4PE03S	-	8.514.000	2
1.5... 3	50	2.9 ... 7		GV4PE07N	GV4P07N	8.771.000	2
	100			GV4PE07S	-	8.955.000	2
3... 5.5	50	5 ... 12.5		GV4PE12N	GV4P12N	8.771.000	2
	100			GV4PE12S	-	8.955.000	2
5.5... 11	50	10 ... 25		GV4PE25N	GV4P25N	8.912.000	2
	100			GV4PE25S	-	9.096.000	2
11... 22	50	20 ... 50		GV4PE50N	GV4P50N	9.175.000	2
	100			GV4PE50S	-	10.431.000	2
18.5... 37	50	40 ... 80		GV4PE80N	GV4P80N	9.363.000	2
	100			GV4PE80S	GV4P80S	9.458.000	2
30... 55	50	65 ... 115		GV4PE115N	GV4P115N	9.566.000	2
	100			GV4PE115S	GV4P115S	9.628.000	2

TeSys Power - GV5 & GV6

Proteksi motor (55 - 250 kW) yang tangguh dan handal.

Tangguh

- Hingga 2000 m
- Hingga 60°C
- Duty Class: 25°C.o/h

Rated insulation voltage (Ui)

800 V AC

Breaking capacity (Icu)

36 kA & 70 kA pada
400/415 V

Rated operational current (Icu)

150 A hingga 500 A pada 400 V AC



Kontak bantu tambahan yang dapat dipasang sendiri

Rotary-handle

Mekanisme penguncian in-house

Kode QR untuk akses langsung pada data teknis elektronik, referensi komersial dan nomor seri produk



Dilengkapi dengan unit thermal-magnetic trip canggih yang memberikan proteksi yang efektif terhadap motor dengan daya tinggi pada aplikasi yang berat sekalipun.



Pengaturan arus beban lebih (*overload*) dan hubungan pendek (*short-circuit*) memberikan fleksibilitas yang optimal.



Rangkaian Aksesori dan kontak bantu yang umum, dapat memfasilitasi kontrol, operasi dan indikasi jarak jauh.



Approvals dan sertifikasi kelas internasional, menjamin kualitas dan mutu produk.





Scan untuk
Data Teknis



GV5



GV6

TeSys Power

Giga

Motor Circuit Breaker GV5 & GV6 (Proteksi Magnetik Termal)

■ GV5

GV5 dengan lebar 105mm diperuntukkan untuk aplikasi motor hingga 110 kW

Motor 400/415 V		Setting Arus Termal, I _r (A)	Referensi	Harga (Rp) (Sebelum PPN)	SS
P (kW)	I _{cu} (kA)				
55...75	36	70...150	GV5P150F	9.712.000	1
	70		GV5P150H	9.932.000	2
99...110	36	100...220	GV5P220F	10.204.000	2
	70		GV5P220H	10.779.000	2

■ GV6

GV6 dengan lebar 140mm dirancang khusus untuk aplikasi motor hingga 250 kW

Motor 400/415 V		Setting Arus Termal, I _r (A)	Referensi	Harga (Rp) (Sebelum PPN)	SS
P (kW)	I _{cu} (kA)				
132...160	36	160...320	GV6P320F	23.300.000	2
	70		GV6P320H	23.782.000	2
200...250	36	250...500	GV6P500F	25.371.000	2
	70		GV6P500H	25.996.000	2

DB432820.ai

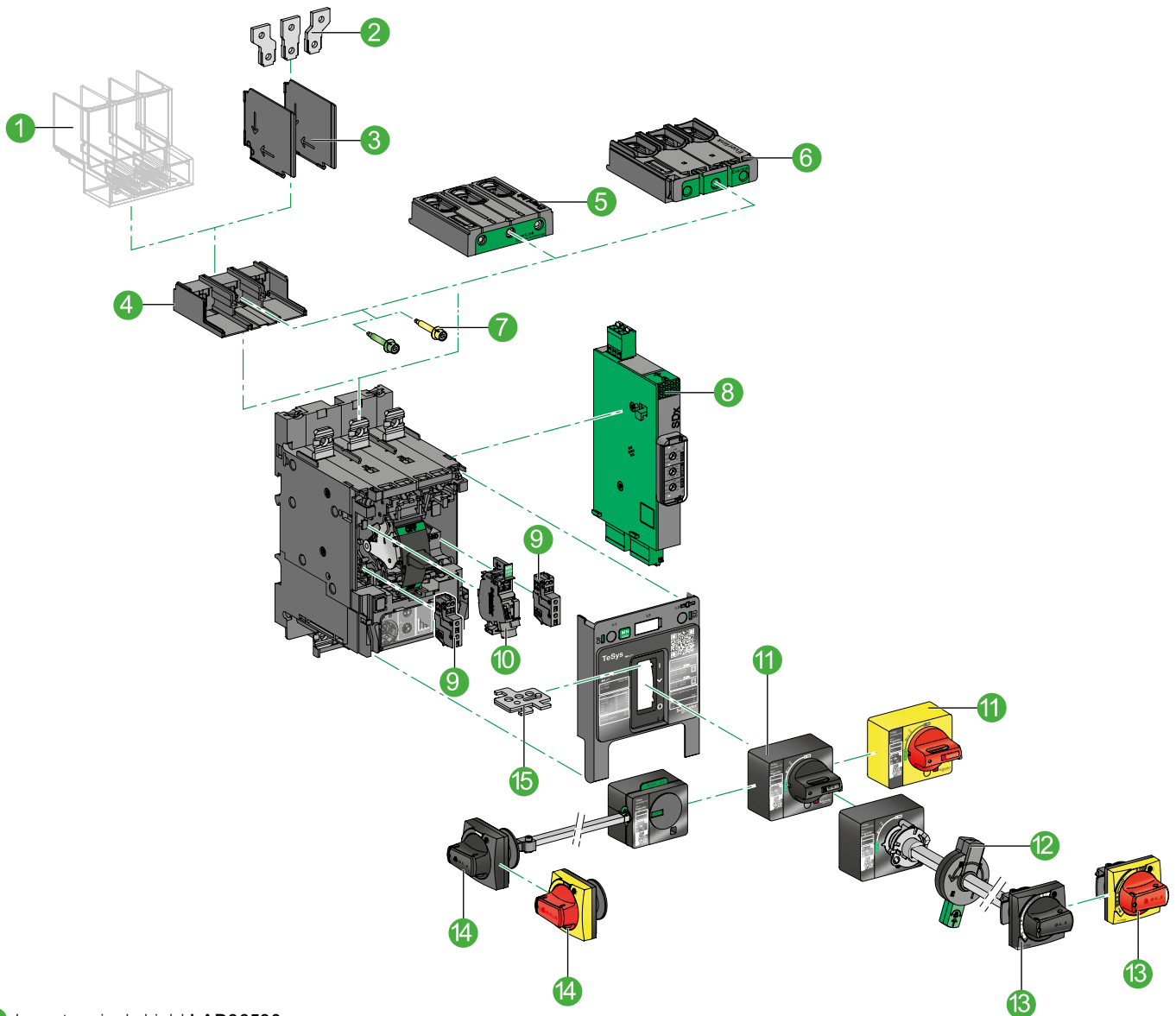

- 1 Long terminal shield **LAD96590**
- 2 Terminal spreaders **LV426940**
- 3 Interphases barriers **LV426920**
- 4 Crimp lug connector **GV4LUG**
- 5 EverLink® connector **LAD96595**
- 6 Everlink® terminals and large spacing cover **GV4G66 + LAD96595**
- 7 Torque limiting breakaway bits **LV42699●**
- 8 SDx alarming/fault differentiation module **GV4ADM1111** (only with GV4PEM)
- 9 Auxiliary contact block for OF or SD function **GV4AE11**
 - MN undervoltage release **GV4AU●●**
 - MX shunt trip **GV4AS●●**
- 11 Direct mounting black or red on yellow bezel rotary handle **GV4ADN01/ GV4ADN02**
- 12 Open door shaft operator (for front extended rotary handle) **LV426937**
- 13 Front extended rotary handle kit with red handle on yellow bezel or black handle **GV4APN01/ GV4APN02 /GV4APN04**
- 14 Side rotary handle kit with red handle on yellow bezel or black handle **LV426935/ LV426936**.
- 15 Toggle locking device **29370**

DB6132813.ai

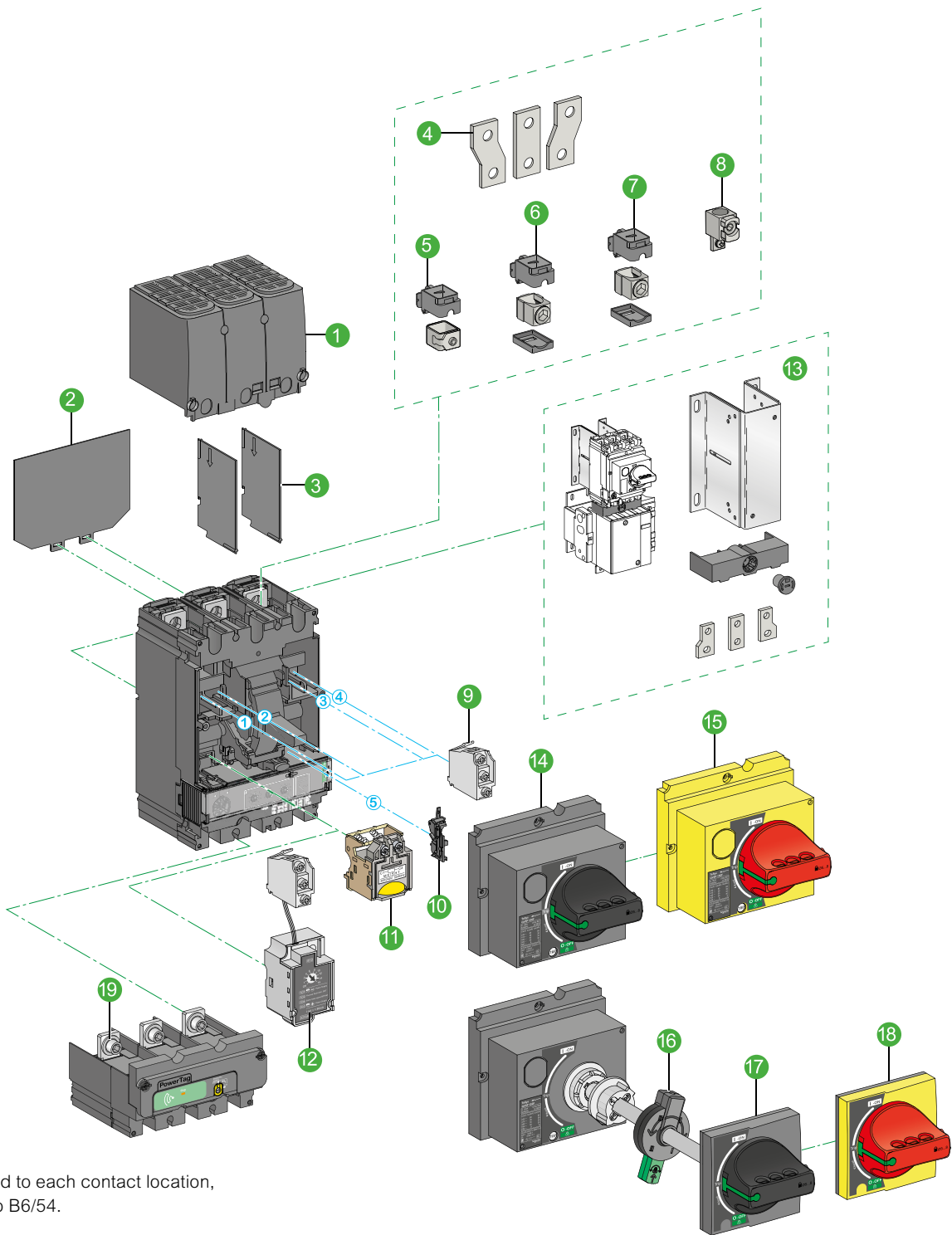

1...5: function related to each contact location,
please refer to B6/54.

- 1 Terminal shield **GV7AC01**
- 2 Insulating screen **GV7AC05**
- 3 Interphase barriers **GV7AC04**
- 4 Spreaders 45 mm **GV7AC03**
- 5 Steel connector **GV7AC021** (1.5-95 mm²)
- 6 Aluminum connector **LV429227** (25-95 mm²)
- 7 Aluminum connector **GV7AC022** (120-185 mm²)
- 8 Aluminum connector **LV429244** (120-240 mm²)
- 9 OF, SD, or SDE indication contacts **GV7AE11** (stand-
ard) / **GV7AB11** (for low level)
- 10 SDE adapter **LV429451**
- 11 AU (UVR) or AS (SHT) voltage release **GV7AU●●●●** / **GV7AS●●●●**
- 12 SDTAM thermal fault module **LV429424**
- 13 Combination kit for contactor **GV7AC06/GV7AC08**
- 14 Direct rotary handle black **GV5AP03** (shipped with the device)
- 15 Direct rotary handle red on yellow bezel **GV7AP04**
- 16 Open door shaft operator **LV426937**
- 17 Extended rotary handle black **GV7AP01**
- 18 Extended rotary handle red on yellow bezel **GV7AP02**
- 19 PowerTag M250 wireless energy sensor **LV434020**

DB432814.ai

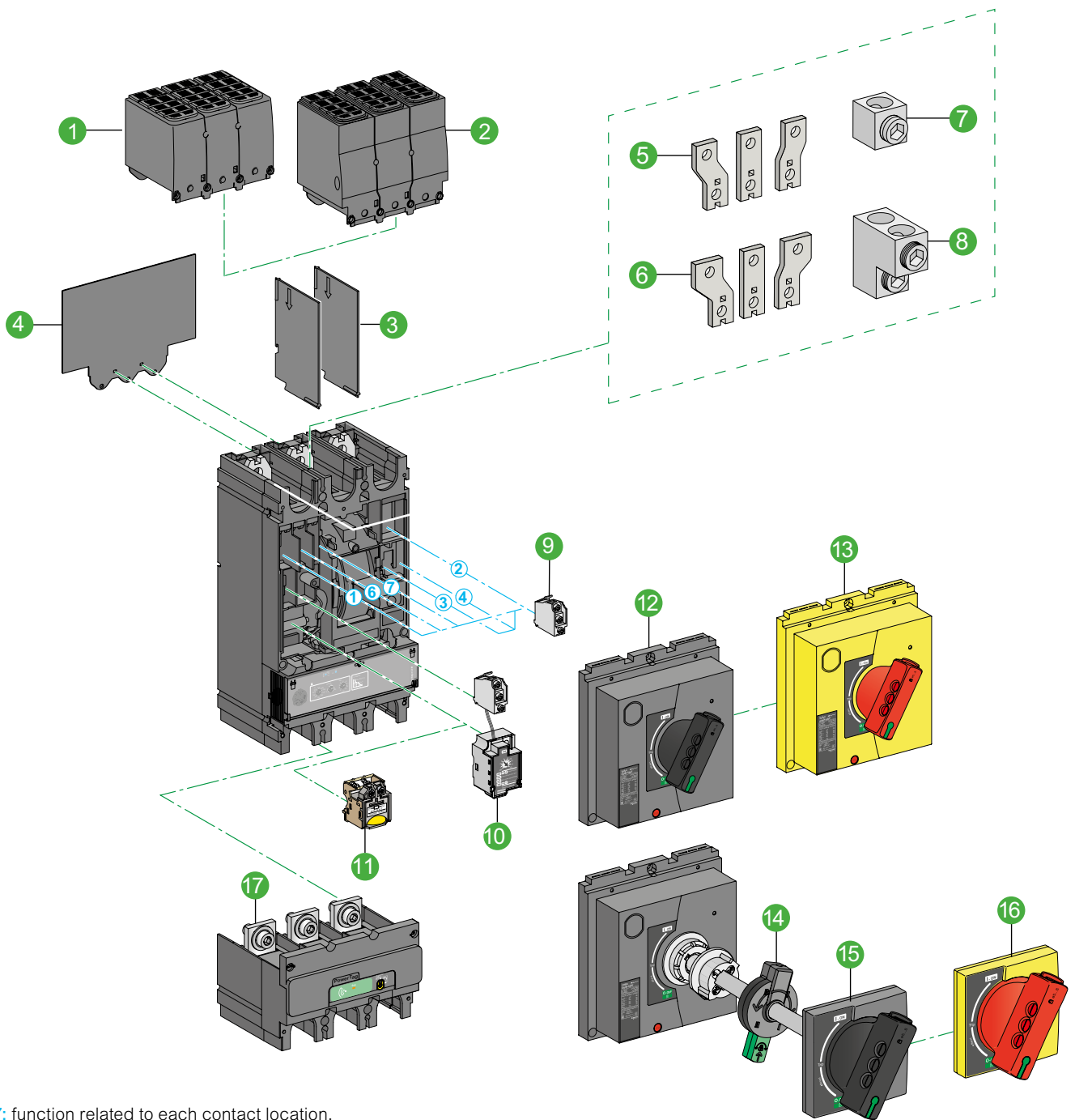

1...7: function related to each contact location,
please refer to B6/54.

- 1 Terminal shield 45 mm LV432593
- 2 Terminal shield 52.5 mm LV432595
- 3 Interphase barriers LV432570
- 4 Insulating screen LV432578
- 5 Spreader 52.5 mm LV432490
- 6 Spreader 70 mm LV432492
- 7 Aluminum connector LV432479 (1 x 35-300 mm2)
- 8 Aluminum connector LV432481 (2 x 35-300 mm2)
- 9 OF, SD, or SDE indication contacts GV7AE11 (standard) / GV7AB11 (for low level)
- 10 SDTAM thermal fault module LV429424
- 11 11 AU (UVR) or AS (SHT) voltage releases GV7AU●●●/ GV7AUS●●●
- 12 Direct rotary handle black GV6AP03 (shipped with the device)
- 13 Direct rotary handle red on yellow bezel LV432599
- 14 Open door shaft operator LV426937
- 15 Extended rotary handle black LV432598
- 16 Extended rotary handle red on yellow bezel LV432600
- 17 PowerTag M630 wireless energy sensor LV434022



Scan untuk
Data Teknis



CA2KN40●●



CAD32●●

TeSys Control CA2K & CAD Relay Kontrol TeSys K dan TeSys Deca

■ Relay Kontrol TeSys K

- Arus (lth) : 10A.
- Tegangan operasional : $\leq 690\text{ V}$, $\leq 400\text{ Hz}$
- Tegangan Kontrol : 24 V AC 50/60 Hz

Tipe Kontrol	Kontak Bantu		Referensi	Harga (Rp) (Sebelum PPN)	SS
	N/O	N/C			
Kontrol 220 V AC	4	-	CA2KN40M7	294.000	2
	3	1	CA2KN31M7	294.000	2
	2	2	CA2KN22M7	294.000	2
Kontrol 24 V DC	4	-	CA3KN40BD	633.000	2
	3	1	CA3KN31BD	633.000	2
	2	2	CA3KN22BD	633.000	2

Catatan : Untuk tipe tegangan coil lainnya silakan hubungi Customer Care Center kami

■ Relay Kontrol TeSys Deca

- Arus (lth) : 10A.
- Tegangan operasional : $\leq 690\text{ V}$, 25...400 Hz
- Tegangan Kontrol : 24 V AC 50/60 Hz

Tipe Kontrol	Kontak Bantu		Referensi	Harga (Rp) (Sebelum PPN)	SS
	N/O	N/C			
Kontrol 220 V AC	5	-	CAD50M7	429.000	2
	3	2	CAD32M7	411.000	1
Kontrol 24 V DC	5	-	CAD50BD	745.000	2
	3	2	CAD32BD	745.000	1

Catatan : Untuk tipe tegangan coil lainnya silakan hubungi Customer Care Center kami



Scan untuk
Data Teknis

TeSys Control

Enclosed Motor Starter

Direct On Line - Non Reverse

■ Panorama Produk LE1M

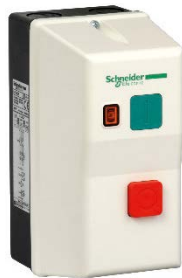

LE1M35●●●

Spesifikasi LE1M

- Berbahan self-extinguished ABS IP 65
- 1 buah kontaktor
- 1 buah thermal overload relay
- 1 buah push button hijau start
- 1 buah push button merah stop/reset
- 1 buah indikator kuning

AC-3 380/400 V (kW)	Setting Arus (A)	Referensi	Harga (Rp) (Sebelum PPN)	SS
0.35	0.54 ... 0.8	LE1M35M705	1.233.000	2
0.37	0.8 ... 1.2	LE1M35M706	1.233.000	2
0.55	1.2 ... 1.8	LE1M35M707	1.233.000	1
1.1	1.8 ... 2.6	LE1M35M708	1.233.000	2
1.5	2.6 ... 3.7	LE1M35M710	1.233.000	1
2.2	3.7 ... 5.5	LE1M35M712	1.233.000	2
3	5.5 ... 8	LE1M35M714	1.292.000	1
4	8 ... 11.5	LE1M35M716	1.294.000	1
5.5	10 ... 14	LE1M35M721	1.377.000	2
7.5	12 ... 16	LE1M35M722	1.377.000	2

Catatan :

- Kode **M7** adalah untuk aplikasi di tegangan 220 VAC
- Untuk tipe tegangan coil lainnya silakan hubungi Customer Care Center kami.

■ Panorama Produk LE1D



LE1D12●●

Spesifikasi LE1D

- Berbahan Polycarbonate IP 55 dan IP 65
- 1 buah kontaktor
- BELUM termasuk thermal overload relay
- 1 buah push button hijau start
- 1 buah push button merah stop/reset

AC-3 380/400 V (kW)	Arus Maksimum (A)	Referensi	Harga (Rp) (Sebelum PPN)	SS
4	9	LE1D09M7	2.896.000	2
5.5	12	LE1D12M7	3.110.000	2
7.5	18	LE1D18M7	5.133.000	2
11	25	LE1D25M7	3.957.000	2
15	35	LE1D35M7	5.105.000	2

Catatan :

- Kode **M7** adalah untuk aplikasi di tegangan 220 VAC
- Untuk tipe tegangan coil lainnya silakan hubungi Customer Care Center kami.



Scan untuk
Data Teknis



LUB●●

LU2B●●2



LUCAX6●●●



LUCB12●●●

TeSys Active

TeSys Ultra

Ultra Motor Starter 1 Komponen Koordinasi Total

Power Base

Starter	AC-3 400 V	Kontak Bantu		Referensi	Harga (Rp) (Sebelum PPN)	SS
	(A)	N/O	N/C			
Direct On Line	12	1	1	LUB12	3.587.000	1
	32	1	1	LUB32	4.113.000	2
Direct On Line Reverse	12	2	-	LU2B12●●●	11.361.000	2
	32	2	-	LU2B32●●●	12.546.000	2

Catatan : Gantikan kode ●● pada referensi untuk tegangan kontrol koil sesuai dengan tabel dibawah

Koil	24 V AC	110 ... 240 V AC/DC
Kode ●●	BL	FU

Control Unit

AC-3 400/440 V	Setting Arus (A)	Rating Power Base	Referensi	Harga (Rp) (Sebelum PPN)	SS
Standard					
0.09	0.15 ... 0.6	12 dan 32	LUCAX6●●●	1.598.000	2
0.25	0.35 ... 1.4	12 dan 32	LUCA1X●●●	3.212.000	2
1.5	1.25 ... 5	12 dan 32	LUCA05●●●	4.681.000	2
5.5	3 ... 12	12 dan 32	LUCA12●●●	5.254.000	2
7.5	4.5 ... 18	32	LUCA18●●●	2.077.000	2
15	8 ... 32	32	LUCA32●●●	5.910.000	2

Advanced

0.09	0.15 ... 0.6	12 dan 32	LUCBX6●●●	3.223.000	2
0.25	0.35 ... 1.4	12 dan 32	LUCB1X●●●	3.399.000	2
1.5	1.25 ... 5	12 dan 32	LUCB05●●●	3.468.000	2
5.5	3 ... 12	12 dan 32	LUCB12●●●	3.886.000	2
7.5	4.5 ... 18	32	LUCB18●●●	4.195.000	2
15	8 ... 32	32	LUCB32●●●	6.255.000	2

Catatan : Gantikan kode ●● pada referensi untuk tegangan kontrol koil sesuai dengan tabel di bawah.

Koil	24 V	110 ... 240 V
DC	BL	FU
AC	-	FU

- Untuk harga LUCAX6BL tidak mengikuti tabel harga, silakan hubungi Customer Care Center kami.



Scan untuk
Data Teknis



LTMR08MBD



LTMR08CBD



LTMR08DBD



LTMR08PBD



LTMEV40BD



LTMCU



LT6CT1001

TeSys Active

TeSys T

Sistem Manajemen Motor

■ Panorama Produk TeSys T

Komunikasi	Setting Arus (A)	Referensi	Harga (Rp) (Sebelum PPN)	SS
ModBus	0.4 - 8	LTMR08MBD	20.736.000	2
	1.35 - 27	LTMR27MBD	20.736.000	2
	5 - 100	LTMR100MBD	20.736.000	2
CAN Open	0.4 - 8	LTMR08CBD	20.366.000	2
	1.35 - 27	LTMR27CBD	21.816.000	2
	5 - 100	LTMR100CBD	20.366.000	2
ProfiBus	0.4 - 8	LTMR08PBD	24.218.000	2
	1.35 - 27	LTMR27PBD	24.218.000	2
	5 - 100	LTMR100PBD	24.218.000	2
Ethernet	0.4 - 8	LTMR08EBD	19.320.000	2
	1.35 - 27	LTMR27EBD	26.451.000	2
	5 - 100	LTMR100EBD	26.503.000	2

Catatan : Tegangan koil (BD) Referensi di atas adalah 24 V DC

■ Aksesori

Deskripsi	Panjang (m)	Referensi	Harga (Rp) (Sebelum PPN)	SS
Modul Ekspansi	-	LTMEV40●●	4.094.000	2
Kabel Koneksi	1	LU9R10	485.000	2
Modul HMI (display)	-	LTMCU	6.209.000	2

■ CT Eksternal

CT kelas 5P, akurasi limit faktor 15

Arus Operasional		Referensi	Harga (Rp) (Sebelum PPN)	SS
Primary A	Secondary A			
200	1	LT6CT2001	2.054.000	2
400	1	LT6CT4001	3.073.000	2



Scan untuk
Data Teknis

TeSys Active

TeSys Island

Panorama Produk

TeSys island dirancang untuk mengontrol, melindungi dan juga mengelola motor dan daya elektrik lainnya hingga 80 A (37 kW / 400 V), dengan segudang benefit:



Hemat Waktu

Perakitan kabel berkurang drastis.



Konfigurasi Lebih Cepat

Tidak perlu melakukan pencarian dengan katalog.



Hemat Perawatan

Perawatan jarak jauh sekarang tersedia.



Integrasi Lebih Mudah

Memungkinkan konektivitas dengan berbagai vendor.



Mengurangi Downtime

Mengurangi biaya operasional dengan notifikasi lebih awal terhadap potensi downtime.



Hemat Suku Cadang

SKU lebih sedikit untuk fungsi yang lebih luas.

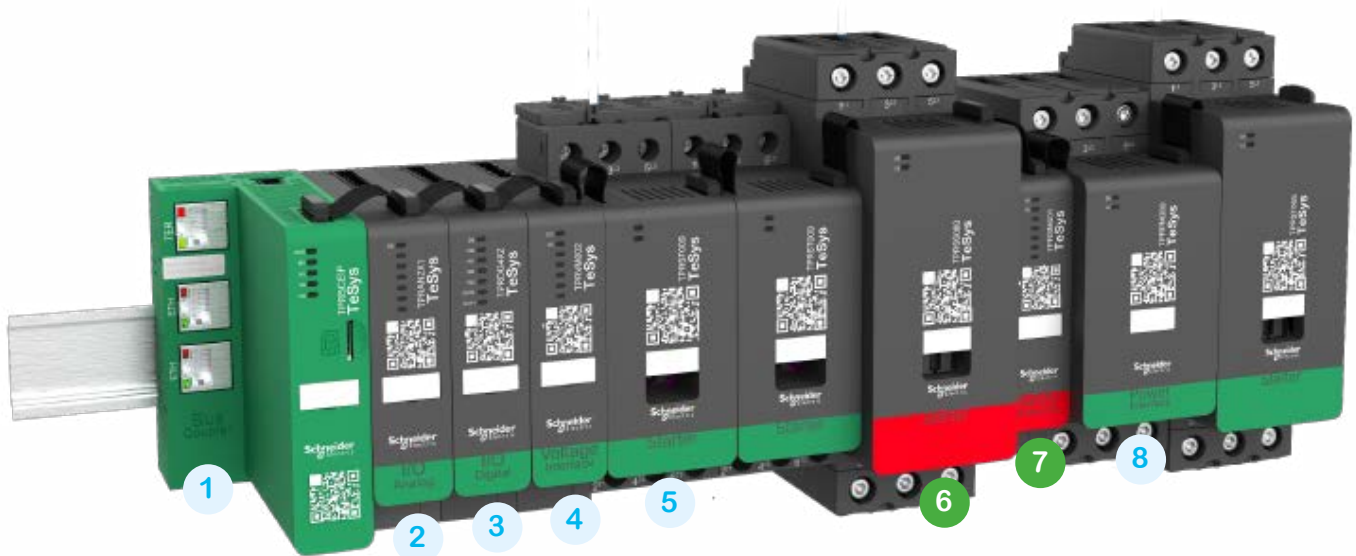

1 Bus coupler

2 Analog I/O module

3 Digital I/O module

4 Voltage interface module

5 Standard starter

6 SIL starter

7 SIL interface module

8 Power interface module



TPRCEIP



TPRDG4X2



TPRVM001



TPRST009

TPRST080



TPRPM038

TeSys Active

TeSys Island

Sistem Pengendalian / Proteksi / Pemantauan Motor

TeSys island Bus Coupler

Field Bus Protocol	Service bus protocol	Referensi	Harga (Rp) (Sebelum PPN)	SS
EtherNet/IP - Modbus TCP	Ethernet TCP/IP	TPRBCEIP	6.995.000	2
PROFINET	Ethernet TCP/IP	TPRBCPFN	6.022.000	2
PROFIBUS	Ethernet TCP/IP	TPRBCPFB	6.719.000	2

TeSys island I/O Module

Deskripsi	Input		Output		Referensi	Harga (Rp) (Sebelum PPN)	SS
	mA DC	VDC	mA DC	VDC			
Analog 2I/1O Module	0 - 20	-10 hingga +10	0 - 20	-10 hingga +10	TPRAN2X1	5.116.000	2
	4 - 20	0 - 10	4 - 20	0 - 10			
Digital 4I/2O Module	-	24	500	24	TPRDG4X2	2.558.000	2

TeSys island Voltage Interface Modue (VIM)

Deskripsi	Phase	Tegangan (V)	Frekwensi (Hz)	Referensi	Harga (Rp) (Sebelum PPN)	SS
Voltage interface module	1P/3P	100 - 690	50 - 60	TPRVM001	3.425.000	2

TeSys island Standard Starters (ST)

Daya standard untuk motor 3 fasa 50-60 Hz dalam kategori AC-3				Arus operasional AC-3 (440V)	Referensi	Harga (Rp) (Sebelum PPN)	SS
220/230V	380/400V	415/440V	500/690V				
2,2	4	4	5,5	9	TPRST009	2.754.000	2
5,5	11	11	15	25	TPRST025	3.830.000	2
9	18,5	18,5	18,5	38	TPRST038	4.068.000	2
18,5	30	30	37	65	TPRST065	7.298.000	2
18,5	37	37	37	66	TPRST080	8.016.000	2

TeSys island Power Interface Modue (PIM)

Daya standard untuk motor 3 fasa 50-60 Hz dalam kategori AC-3				Arus operasional AC-3 @440V (A)	Referensi	Harga (Rp) (Sebelum PPN)	SS
220/230V	380/400V	415/440V	500/690V				
2,2	4	4	5,5	9	TPRPM009	2.308.000	2
9	18,5	18,5	18,5	38	TPRPM038	2.885.000	2
22	37	37	37	80	TPRPM080	3.577.000	2

EcoStruxure™ Motor Control Configurator



Online configurator untuk pemilihan solusi motor starter secara cepat dan tepat.

Scan untuk menggunakan
Ecostruxure™ Motor Control Configurator

3-Components Solution

(Magnetic circuit breaker or fuse + Contactor + TOR)

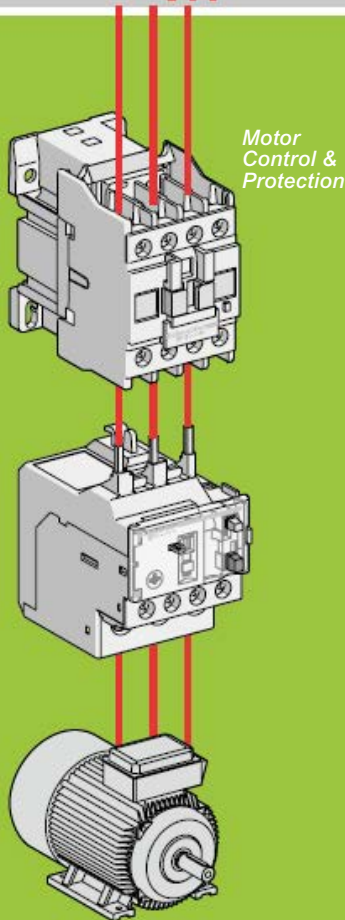
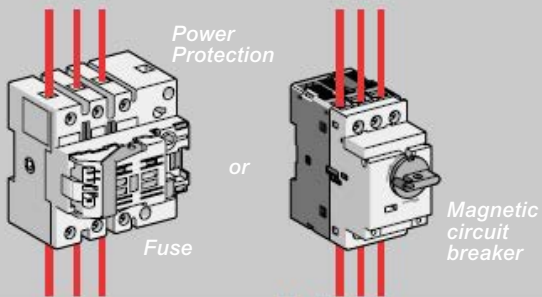

2-Components Solution

(Thermal-magnetic circuit breaker + Contactor)

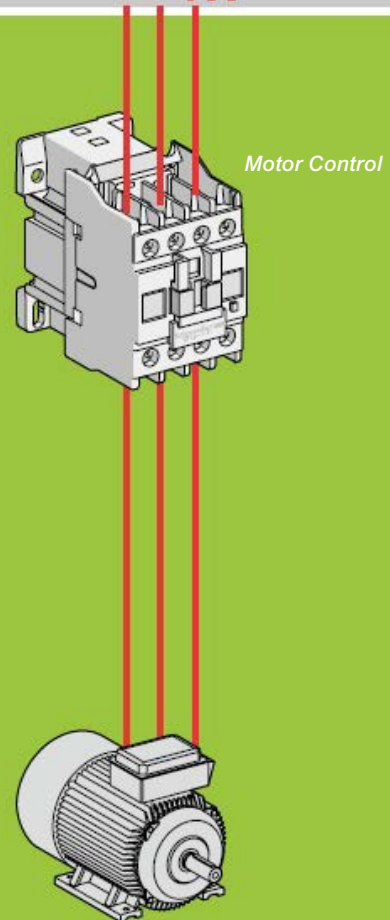
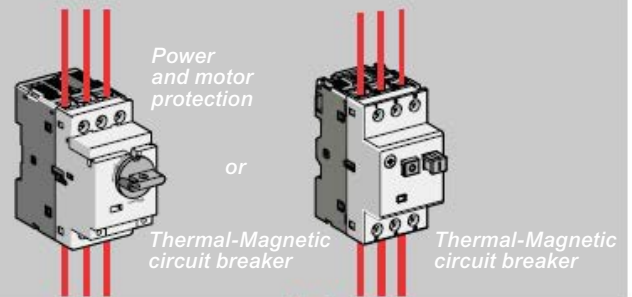



Scan untuk menggunakan
Ecostruxure™ Motor
Control Configurator

Petunjuk Pemilihan Motor Starter Direct On Line (Easy TeSys) Koordinasi Tipe 1 (performa standard)

Asosiasi 2 Komponen

AC-3 400/415 V		CB untuk motor + Relay Thermal	Kontaktor
P (kW)	I _e (A)		
0,06	0,2	GV2ME02	LC1E0610●●
0,09	0,3	GV2ME03	LC1E0610●●
0,12	0,44	GV2ME04	LC1E0610●●
0,18	0,6	GV2ME04	LC1E0610●●
0,25	0,85	GV2ME05	LC1E0610●●
0,37	1,1	GV2ME05	LC1E0610●●
0,55	1,5	GV2ME06	LC1E0610●●
0,75	1,9	GV2ME07	LC1E0610●●
1,1	2,7	GV2ME08	LC1E0610●●
1,5	3,6	GV2ME08	LC1E0610●●
2,2	4,9	GV2ME10	LC1E0610●●
3	6,5	GV2ME14	LC1E0910●●
4	8,5	GV2ME14	LC1E0910●●
5,5	11,5	GV2ME16	LC1E1210●●
7,5	15,5	GV2ME20	LC1E1810●●
9	18,1	GV2ME21	LC1E2510●●
11	22	GV2ME22	LC1E2510●●
15	29	GV2ME32	LC1E3210●●
18,5	35	GV3P40	LC1E40●●
22	41	GV3P50	LC1E50●●
30	55	GV3P65	LC1E65●●
37	66	GV3P73	LC1E80●●

Asosiasi 3 Komponen

AC-3 400/415 V		CB untuk motor	Kontaktor	Relay Thermal
P (kW)	I _e (A)			
0.06	0.2	GV2L03	LC1E0610●●	LRE02
0.09	0.3	GV2L03	LC1E0610●●	LRE03
0.12	0.44	GV2L04	LC1E0610●●	LRE05
0.18	0.6	GV2L04	LC1E0610●●	LRE05
0.25	0.85	GV2L05	LC1E0610●●	LRE05
0.37	1.1	GV2L05	LC1E0610●●	LRE06
0.55	1.5	GV2L06	LC1E0610●●	LRE06
0.75	1.9	GV2L07	LC1E0610●●	LRE07
1.1	2.7	GV2L07	LC1E0610●●	LRE08
1.5	3.6	GV2L08	LC1E0610●●	LRE08
2.2	4.9	GV2L10	LC1E0610●●	LRE10
3	6.5	GV2L14	LC1E0910●●	LRE12
4	8.5	GV2L14	LC1E0910●●	LRE14
5.5	11.5	GV2L16	LC1E1210●●	LRE16
7.5	15.5	GV2L20	LC1E1810●●	LRE21
9	18.1	GV2L22	LC1E2510●●	LRE22
11	22	GV2L22	LC1E2510●●	LRE22
15	29	GV2L32	LC1E3210●●	LRE32
18.5	35	GV3L40	LC1E40●●	LRE355
22	41	GV3L50	LC1E50●●	LRE357
30	55	GV3L65	LC1E65●●	LRE359
37	66	GV4LE80N	LC1E80●●	LRE361



Scan untuk menggunakan
Ecostruxure™ Motor
Control Configurator

Petunjuk Pemilihan Motor Starter Star Delta (Easy TeSys) Koordinasi Tipe 1 (performa standard)

Asosiasi 2 Komponen

AC-3 400/415 V			CB untuk motor + Relay Thermal	Kontraktor Star (KM1)	Kontraktor Delta (KM2)	Kontraktor Line (KM3)
P (kW)	Ie (A)	IrD (A)				
5.5	11.5	6.4	GV2ME16	LC1E0901●●	LC1E0901●●	LC1E0910●●
7.5	15.5	8.6	GV2ME20	LC1E0901●●	LC1E0901●●	LC1E0910●●
9	18.1	10	GV2ME21	LC1E1201●●	LC1E1201●●	LC1E1210●●
11	22	12	GV2ME22	LC1E1201●●	LC1E1201●●	LC1E1810●●
15	29	17	GV2ME32	LC1E1801●●	LC1E1801●●	LC1E1810●●
18.5	35	20	GV3P40	LC1E2501●●	LC1E2501●●	LC1E2510●●
22	41	24	GV3P50	LC1E2501●●	LC1E2501●●	LC1E2510●●
30	55	33	GV3P65	LC1E3201●●	LC1E3201●●	LC1E3210●●
37	66	40	GV3P65	LC1E40●●	LC1E40●●	LC1E40●●

Catatan :

- Tambahkan Aksesori **LAEN11** pada kontaktor star(KM1)
- Tambahkan Aksesori **LADS2** pada kontaktor line(KM3) yang digunakan untuk timer
- Untuk motor dengan daya > 100 kW, tambahkan 1 Relay kontrol **CAD32●●**

Asosiasi 3 Komponen

AC-3 400/415 V			CB untuk motor	Kontraktor Star (KM1)	Kontraktor Delta (KM2)	Kontraktor Line (KM3)	Relay Thermal
P (kW)	Ie (A)	IrD (A)					
5.5	11.5	6.4	GV2L16	LC1E0901●●	LC1E0901●●	LC1E0910●●	LRE12
7.5	15.5	8.6	GV2L20	LC1E0901●●	LC1E0901●●	LC1E0910●●	LRE14
9	18.1	10	GV2L22	LC1E1201●●	LC1E1201●●	LC1E1210●●	LRE16
11	22	12	GV2L22	LC1E1201●●	LC1E1201●●	LC1E1810●●	LRE16
15	29	17	GV2L32	LC1E1801●●	LC1E1801●●	LC1E1810●●	LRE21
18.5	35	20	GV3L40	LC1E2501●●	LC1E2501●●	LC1E2510●●	LRE22
22	41	24	GV3L50	LC1E2501●●	LC1E2501●●	LC1E2510●●	LRE32
30	55	33	GV3L65	LC1E3201●●	LC1E3201●●	LC1E3210●●	LRE35
37	66	40	GV4LE80N	LC1E40●●	LC1E40●●	LC1E40●●	LRE355

Catatan :

- Tambahkan Aksesori **LAEN11** pada kontaktor star(KM1)
- Tambahkan Aksesori **LADS2** pada kontaktor line(KM3) yang digunakan untuk timer
- Untuk motor dengan daya > 100 kW, tambahkan 1 Relay kontrol **CAD32●●**
- Relay termal dipasangkan pada kontaktor delta



Scan untuk menggunakan
Ecostruxure™ Motor
Control Configurator

Petunjuk Pemilihan Motor Starter Direct On Line Koordinasi Tipe 1 (performa standard)

Asosiasi 2 Komponen

AC-3 400/415 V			CB untuk motor + Relay Thermal	Kontaktor
P (kW)	I _e (A)	I _q (kA)		
	0,2	50	GV2ME02	LC1K06●● / LC1D09●●
0,09	0,3	50	GV2ME03	LC1K06●● / LC1D09●●
0,12	0,44	50	GV2ME04	LC1K06●● / LC1D09●●
0,18	0,6	50	GV2ME04	LC1K06●● / LC1D09●●
0,25	0,85	50	GV2ME05	LC1K06●● / LC1D09●●
0,37	1,1	50	GV2ME05	LC1K06●● / LC1D09●●
0,55	1,5	50	GV2ME06	LC1K06●● / LC1D09●●
0,75	1,9	50	GV2ME07	LC1K06●● / LC1D09●●
1,1	2,7	50	GV2ME08	LC1K06●● / LC1D09●●
1,5	3,6	50	GV2ME08	LC1K06●● / LC1D09●●
2,2	4,9	50	GV2ME10	LC1K06●● / LC1D09●●
3	6,5	50	GV2ME14	LC1K09●● / LC1D09●●
4	8,5	50	GV2ME14	LC1K09●● / LC1D09●●
5,5	11,5	15	GV2ME16	LC1K12●● / LC1D12●●
7,5	15,5	15	GV2ME20	LC1D18●●
9	18,1	15	GV2ME21	LC1D25●●
11	22	15	GV2ME22	LC1D25●●
15	29	10	GV2ME32	LC1D32●●
18,5	35	50	GV3P40	LC1D40A●●
22	41	50	GV3P50	LC1D50A●●
30	55	50	GV3P65	LC1D65A●●
37	66	50	GV3P73	LC1D80●●
45	80	100	GV4P80	LC1D95●●
55	97	100	GV4P115	LC1D115●●
75	132	36	GV5P150F	LC1D150●●

Asosiasi 3 Komponen

AC-3 400/415 V			CB untuk motor	Kontaktor	Relay Thermal
P (kW)	I _e (A)	I _q (kA)			
0,06	0,2	50	GV2L03	LC1K06●●	LR2K0302
0,09	0,3	50	GV2L03	LC1K06●●	LR2K0304
0,12	0,44	50	GV2L04	LC1K06●●	LR2K0304
0,18	0,6	50	GV2L04	LC1K06●●	LR2K0305
0,25	0,85	50	GV2L05	LC1K06●●	LR2K0306
0,37	1,1	50	GV2L05	LC1K06●●	LR2K0306
0,55	1,5	50	GV2L06	LC1K06●●	LR2K0307
0,75	1,9	50	GV2L07	LC1K06●●	LR2K0308
1,1	2,7	50	GV2L07	LC1K06●●	LR2K0308
1,5	3,6	50	GV2L08	LC1K06●●	LR2K0310
2,2	4,9	50	GV2L10	LC1K06●●	LR2K0312
3	6,5	50	GV2L14	LC1K09●●	LR2K0314
4	8,5	50	GV2L14	LC1K09●●	LR2K0316
5,5	11,5	15	GV2L16	LC1K12●●	LR2K0321
7,5	15,5	15	GV2L20	LC1D18●●	LRD21
9	18,1	15	GV2L22	LC1D25●●	LRD22
11	22	15	GV2L22	LC1D25●●	LRD22
15	29	10	GV2L32	LC1D32●●	LRD32
18,5	35	50	GV3L40	LC1D40A●●	LRD340
22	41	50	GV3L50	LC1D50A●●	LRD350
30	55	50	GV3L65	LC1D65A●●	LRD365
37	66	50	GV4L80	LC1D80●●	LRD3361
45	80	100	GV4L115	LC1D115●●	LRD3365
55	97	100	GV4L115	LC1D115●●	LRD4367



Scan untuk menggunakan
Ecostruxure™ Motor
Control Configurator

Petunjuk Pemilihan Motor Starter Direct On Line Koordinasi Tipe 2 (performa tinggi)

Asosiasi 2 Komponen

AC-3 400/415 V			CB untuk motor + Relay Thermal	Kontaktor
P (kW)	Ie (A)	Iq (max) (kA)		
0,06	0,2	130	GV2ME02 / GV2P02	LC1D09●●
0,09	0,3	130	GV2ME03 / GV2P03	LC1D09●●
0,12	0,44	130	GV2ME04 / GV2P04	LC1D09●●
0,18	0,6	130	GV2ME04 / GV2P04	LC1D09●●
0,25	0,85	130	GV2ME05 / GV2P05	LC1D09●●
0,37	1,1	130	GV2ME05 / GV2P05	LC1D09●●
0,55	1,5	130	GV2ME06 / GV2P06	LC1D09●●
0,75	1,9	130	GV2ME07 / GV2P07	LC1D09●●
1,1	2,7	130	GV2ME08 / GV2P08	LC1D09●●
1,5	3,6	130	GV2ME08 / GV2P08	LC1D09●●
2,2	4,9	130	GV2ME10 / GV2P10	LC1D09●●
3	6,5	130	GV2ME14 / GV2P14	LC1D09●●
4	8,5	130	GV2ME14 / GV2P14	LC1D09●●
5,5	11,5	130	GV2ME16 / GV2P16	LC1D25●●
7,5	15,5	50	GV2ME20 / GV2P20	LC1D25●●
9	18,1	50	GV2ME21 / GV2P21	LC1D25●●
11	22	50	GV2ME22 / GV2P22	LC1D25●●
15	29	50	GV2ME32 / GV2P32	LC1D32●●
18,5	35	50	GV3P40	LC1D50A●●
22	41	50	GV3P50	LC1D50A●●
30	55	50	GV3P65	LC1D65A●●
37	66	50	GV3P73	LC1D80●●
45	80	100	GV4P/GV4PE115	LC1G115●●
55	97	100	GV4P/GV4PE115	LC1G115●●
75	132	70	GV5P150H	LC1G150●●
90	160	70	GV5P220H	LC1G185●●
110	195	70	GV5P220H	LC1G225●●
132	230	70	GV6P320H	LC1G265●●
160	280	70	GV6P320H	LC1G330●●
200	350	70	GV6P500H	LC1G400●●
220	380	70	GV6P500H	LC1G500●●
250	450	70	GV6P500H	LC1G500●●

Asosiasi 3 Komponen

AC-3 400/415 V			CB untuk motor	Kontaktor	Relay Thermal
P (kW)	Ie (A)	Iq (max) (kA)			
0,06	0,2	130	GV2L03	LC1D09●●	LRD02
0,09	0,3	130	GV2L03	LC1D09●●	LRD03
0,12	0,44	130	GV2L04	LC1D09●●	LRD04
0,18	0,6	130	GV2L04	LC1D09●●	LRD04
0,25	0,85	130	GV2L05	LC1D09●●	LRD05
0,37	1,1	130	GV2L05	LC1D09●●	LRD05
0,55	1,5	130	GV2L06	LC1D09●●	LRD06
0,75	1,9	130	GV2L07	LC1D09●●	LRD07
1,1	2,7	130	GV2L08	LC1D09●●	LRD08
1,5	3,6	130	GV2L08	LC1D09●●	LRD08
2,2	4,9	130	GV2L10	LC1D09●●	LRD10
3	6,5	130	GV2L14	LC1D09●●	LRD12
4	8,5	130	GV2L14	LC1D09●●	LRD14
5,5	11,5	130	GV2L16	LC1D25●●	LRD16
7,5	15,5	50	GV2L20	LC1D25●●	LRD21
9	18,1	50	GV2L22	LC1D25●●	LRD22
11	22	50	GV2L22	LC1D25●●	LRD22
15	29	50	GV2L32 *	LC1D40A●●	LRD332
18,5	35	50	GV3L40	LC1D50A●●	LRD340
22	41	50	GV3L50	LC1D50A●●	LRD350
30	55	50	GV3L65	LC1D65A●●	LRD365
37	66	50	GV3L73	LC1D80●●	LRD380
45	80	50	GV3L80	LC1D95●●	LRD3363
45	80	100	GV4L/GV4LE115	LC1G115	LR9G115
55	97	50	GV4L115	LC1D115●●	LRD5369
55	97	100	GV4L/GV4LE115	LC1G115	LR9G225
75	132	130	NSX160● + MA	LC1G150	LR9G225
90	160	130	NSX250● + MA	LC1G185	LR9G225
110	195	130	NSX250● + MA	LC1G225	LR9G225
132	230	130	NSX400● + Micrologic 1.3 M	LC1G265	LR9G500
160	280	130	NSX400● + Micrologic 1.3 M	LC1G330	LR9G500
200	350	130	NSX400● + Micrologic 1.3 M	LC1G400	LR9G500
220	380	130	NSX400● + Micrologic 1.3 M	LC1G500	LR9G500
250	430	130	NSX400● + Micrologic 1.3 M	LC1G500	LR9G500
300	460	130	NS800● + Micrologic 5.0 LR OFF	LC1G630	LR9G630
335	575	130	NS800● + Micrologic 5.0 LR OFF	LC1G630	LR9G630

*) Untuk mempermudah koneksi, gantikan GV2L32 dengan GV3L40 (koneksi EverLink)



Scan untuk menggunakan
Ecostruxure™ Motor
Control Configurator

Petunjuk Pemilihan Motor Starter Star Delta Koordinasi Tipe 1 (performa standard)

Asosiasi 2 Komponen

AC-3 400/415 V			CB untuk motor + Relay Thermal	Kontraktor Star (KM1)	Kontraktor Delta (KM2)	Kontraktor Line (KM3)
P (kW)	Ie (A)	IrD (A)				
5,5	11,5	6,4	GV2ME16	LC1D09●●	LC1D09●●	LC1D09●●
7,5	15,5	8,6	GV2ME20	LC1D09●●	LC1D09●●	LC1D09●●
9	18,1	10	GV2ME21	LC1D12●●	LC1D12●●	LC1D12●●
11	22	12	GV2ME22	LC1D12●●	LC1D12●●	LC1D12●●
15	29	17	GV2ME32	LC1D18●●	LC1D18●●	LC1D18●●
18,5	35	20	GV3P40	LC1D18●●	LC1D18●●	LC1D18●●
22	41	24	GV3P50	LC1D32●●	LC1D32●●	LC1D32●●
30	55	33	GV3P65	LC1D32●●	LC1D32●●	LC1D32●●
37	66	40	GV3P65	LC1D40A●●	LC1D40A●●	LC1D40A●●
45	80	47	GV4P115	LC1D40A●●	LC1D50A●●	LC1D50A●●
55	97	58	GV4P115	LC1D40A●●	LC1D65A●●	LC1D65A●●
75	132	78	GV5P150F	LC1D80●●	LC1D80●●	LC1D80●●
90	160	95	GV5P220F	LC1D115●●	LC1D115●●	LC1D115●●
110	195	115				
132	230	135	GV6P320F	LC1D150●●	LC1D150●●	LC1D150●●

Catatan :

- Tambahkan Aksesori **LADS2** pada kontaktor line(KM3) yang digunakan untuk timer
- Untuk motor dengan daya > 100 kW, tambahkan 1 relay kontrol **CAD32●●**

Asosiasi 3 Komponen

AC-3 400/415 V			CB untuk motor	Kontraktor Star (KM1)	Kontraktor Delta (KM2)	Kontraktor Line (KM3)	Relay Thermal
P (kW)	Ie (A)	IrD (A)					
5,5	11,5	6	GV2L16	LC1D09●●	LC1D09●●	LC1D09●●	LRD12
7,5	15,5	9	GV2L20	LC1D09●●	LC1D09●●	LC1D09●●	LRD14
9	18,1	10	GV2L22	LC1D12●●	LC1D12●●	LC1D12●●	LRD16
11	22	12	GV2L22	LC1D12●●	LC1D12●●	LC1D12●●	LRD16
15	29	16	GV2L32	LC1D18●●	LC1D18●●	LC1D18●●	LRD21
18,5	35	20	GV3L40	LC1D18●●	LC1D18●●	LC1D18●●	LRD22
22	41	24	GV3L50	LC1D32●●	LC1D32●●	LC1D32●●	LRD32
30	55	33	GV3L65	LC1D32●●	LC1D32●●	LC1D32●●	LRD35
37	66	40	GV4L/LE80	LC1D40A●●	LC1D40A●●	LC1D40A●●	LRD350
45	80	47	GV4L/LE115	LC1D40A●●	LC1D50A●●	LC1D50A●●	LRD350
55	97	58	GV4L/LE115	LC1D40A●●	LC1D50A●●	LC1D50A●●	LRD365
75	132	78	NSX160●MA	LC1D80●●	LC1D80●●	LC1D80●●	LRD3363
90	160	96	NSX250●MA	LC1D115●●	LC1D115●●	LC1D115●●	LRD4365
110	195	116	NSX250●MA	LC1D115●●	LC1D115●●	LC1D115●●	LRD4367

Catatan :

- Tambahkan Aksesori **LADS2** pada kontaktor line(KM3) yang digunakan untuk timer.
- Untuk motor dengan daya > 100 kW, tambahkan 1 relay kontrol **CAD32●●**
- Relay Thermal dipasang pada kontaktor delta.



Scan untuk menggunakan
Ecostruxure™ Motor
Control Configurator

Petunjuk Pemilihan Motor Starter Star Delta Koordinasi Tipe 2 (performa tinggi)

Asosiasi 2 Komponen

AC-3 400/415 V			CB untuk motor + Relay Thermal	Kontraktor Star (KM1)	Kontraktor Delta (KM2)	Kontraktor Line (KM3)
P (kW)	Ie (A)	Iq (kA)				
5,5	11,5	130	GV2P16	LC1D25●●	LC1D25●●	LC1D25●●
7,5	15,5	50	GV2P20	LC1D25●●	LC1D25●●	LC1D25●●
9	18,1	50	GV2P21	LC1D25●●	LC1D25●●	LC1D25●●
11	22	50	GV2P22	LC1D25●●	LC1D25●●	LC1D25●●
15	29	50	GV2P32	LC1D40A●●	LC1D40A●●	LC1D40A●●
18,5	35	50	GV3P40	LC1D40A●●	LC1D50A●●	LC1D50A●●
22	41	50	GV3P50	LC1D40A●●	LC1D50A●●	LC1D50A●●
30	55	50	GV3P65	LC1D40A●●	LC1D65A●●	LC1D65A●●
37	66	100	GV4P80	LC1D80A●●	LC1D80A●●	LC1D80A●●
45	80	100	GV4P115	LC1D115●●	LC1D115●●	LC1D115●●
55	97	100	GV4P115	LC1D115●●	LC1D115●●	LC1D115●●
75	132	70	GV5P150H	LC1D150●●	LC1D150●●	LC1D150●●
90	160	70	GV5P220H	LC1D65A●●	LC1G115●●	LC1G115●●
110	195	70	GV5P220H	LC1D80●●	LC1G150●●	LC1G150●●
132	230	70	GV6P320H	LC1D95●●	LC1G150●●	LC1G150●●
160	280	70	GV6P320H	LC1G115●●	LC1G185●●	LC1G185●●
200	350	70	GV6P500H	LC1G115●●	LC1G225●●	LC1G225●●
220	380	70	GV6P500H	LC1G150●●	LC1G265●●	LC1G265●●
250	430	70	GV6P500H	LC1G150●●	LC1G265●●	LC1G265●●

Catatan :

- Tambahkan Aksesori **LADS2** pada kontaktor line(KM3) yang digunakan untuk timer
- Untuk motor dengan daya > 100 kW, tambahkan 1 relay kontrol **CAD32●●**

Asosiasi 3 Komponen

AC-3 400/415 V			CB untuk motor	Kontraktor Star (KM1)	Kontraktor Delta (KM2)	Kontraktor Line (KM3)	Relay Thermal
P (kW)	Ie (A)	Iq (kA)					
5,5	11,5	50	GV2L16	LC1D25●●	LC1D25●●	LC1D25●●	LRD16
7,5	15,5	50	GV2L20	LC1D25●●	LC1D25●●	LC1D25●●	LRD21
9	18,1	50	GV2L22	LC1D25●●	LC1D25●●	LC1D25●●	LRD22
11	22	50	GV2L22	LC1D25●●	LC1D25●●	LC1D25●●	LRD22
15	29	50	GV2L32	LC1D40A●●	LC1D40A●●	LC1D40A●●	LRD332
18,5	35	50	GV3L40	LC1D40A●●	LC1D50A●●	LC1D50A●●	LRD340
22	41	50	GV3L50	LC1D40A●●	LC1D50A●●	LC1D50A●●	LRD350
30	55	50	GV3L65	LC1D40A●●	LC1D65A●●	LC1D65A●●	LRD365
37	66	100	GV4L/LE80	LC1D80●●	LC1D80●●	LC1D80●●	LRD3363
45	80	100	GV4L/LE115	LC1D115●●	LC1D115●●	LC1D115●●	LR9D5367
55	97	100	GV4L/LE115	LC1D115●●	LC1D115●●	LC1D115●●	LR9D5369
75	132	*	NSX160●MA	LC1D150●●	LC1D150●●	LC1D150●●	LR9D5369
90	160	130	NSX250●MA	LC1D65A●●	LC1G115●●	LC1G115●●	LR9GF115
110	195	130	NSX250●MA	LC1D80●●	LC1G150●●	LC1G150●●	LR9G225
132	230	130	NSX400● + Micrologic 1.3M	LC1D80●●	LC1G150●●	LC1G150●●	LR9G225
160	280	130	NSX400● + Micrologic 1.3M	LC1G115●●	LC1G150●●	LC1G150●●	LR9G225
200	350	130	NSX400● + Micrologic 1.3M	LC1G150●●	LC1G225●●	LC1G225●●	LR9G225
220	380	130	NSX400● + Micrologic 1.3M	LC1G150●●	LC1G265●●	LC1G265●●	LR9G500
250	430	130	NSX800● + MicroLogic 5.0 LR OFF	LC1G185●●	LC1G265●●	LC1G265●●	LR9G500
300	460	130	NSX800● + MicroLogic 5.0 LR OFF	LC1G225●●	LC1G330●●	LC1G330●●	LR9G500
335	575	130	NSX800● + MicroLogic 5.0 LR OFF	LC1G225●●	LC1G400●●	LC1G400●●	LR9G500
355	610	130	NSX800● + MicroLogic 5.0 LR OFF	LC1G225●●	LC1G400●●	LC1G400●●	LR9G500
400	627	130	NSX800● + MicroLogic 5.0 LR OFF	LC1G225●●	LC1G400●●	LC1G400●●	LR9G500
450	695	130	NSX800● + MicroLogic 5.0 LR OFF	LC1G265●●	LC1G500●●	LC1G500●●	LR9G500

Catatan :

- Tambahkan Aksesori **LADS2** pada kontaktor line(KM3) yang digunakan untuk timer.
- Untuk motor dengan daya > 100 kW, tambahkan 1 relay kontrol **CAD32●●**
- Relay Thermal dipasangkan pada kontaktor delta.

*) Referensi harus dilengkapi dengan mengganti ● dengan kode *breaking performance*:

Breaking performance Iq (kA)	NSX100●MA		NSX160●MA, NSX250●MA		NSX400●, NSX630●	
400/415 V	36	70	36	70	70	150
440 V	35	65	35	65	65	130
Code	F	H	F	H	H	L



Source-changeover systems

Automatic Transfer Switches	9-3
TransferPacT ATS	9-6
TransferPacT Automatic ATS	9-6
TransferPacT Active Automatic ATS	9-6
TransferPacT Automatic - Aksesori	9-7
WOTPC ATS	9-8
WOTPC ATS - Overview	9-9
WOTPC ATS	9-10
WOTPC ATS - Aksesori	9-10
WOTPC ATS - Spare Parts	9-10
GoPacT MTS	9-11
GoPacT MTS - Complete Assembly & Aksesori	9-11
GoPacT MTS - Spare Parts	9-12



Automatic Transfer Switches

Power available always when you need it

Transfer Switches make backup power possible. They enhance power availability by transferring electrical loads to alternate sources of power. From simple backup solutions to mission-critical facilities, transfer switches connect backup power to enhance safety and sustain operations.

se.com/id



ASCO Power Technologies™

The 7000 SERIES Automatic Transfer Bypass-Isolation Switch is intended for critical applications where continuous power is required

- Allows bypass-isolation without load interruption
- Primary transfer switch can be inspected, tested, and maintained without interrupting power to the load
- Transfer switch and bypass transfer switch have identical electrical ratings
- Range: 150 to 4000 amps
- Draw-out design allows for easy transfer switch maintenance
- Open Transition (OTTS), Closed Transition (CTTS) and Delayed Transition (DTTS) Designs

Advanced transfer switch to maximize

UPTIME

TransferPacT Active Automatic is now ready to deliver maximum uptime and safety with a complete range from 32A to 1600A

- Conforming to IEC 60947-6-1
- Optimize panel space by up to 30%, saving cost and improving efficiency
- Ultra fast transfer speed for better power availability
- Solenoid operated, Built-in Microprocessor Controller
- Robust design
- Utilization Category: AC 33B
- Poles: 2,3,4
- Scalable with plug and play - 10 function modules
- Connectivity with complaint to cyber security standard IEC 62443, SL 1 Level

TransferPacT™ Active Automatic



#SourceManagement

se.com/id

Life Is On

Schneider
Electric

TransferPacT Automatic Transfer Switch

TransferPacT Automatic ATS & Active Automatic ATS



TransferPacT is an Ecostruxure-ready advance transfer switch to maximize reliability and uptime for your facility.

- Conforming to IEC 60947-6-1
- Solenoid operated, Built-in Microprocessor Controller
- Fast transfer time of <500ms
- 2, 3 and 4 Pole configuration ranging within 32-1600A
- Three position, Open transition transfer switch
- Extreme Environment proof with operating temperature of -25 to 70 °C
- Utilization Category: AC 33B
- Tested for Total Discrimination with ComPacT NSXm Circuit breakers for seamless integration.
- Scalable with plug and play - 10 function modules
- Connectivity with compliant to cyber security standard IEC 62443, SL1 Level

TransferPacT Automatic ATS

Frame	Rating (Amps)	2P Referensi	Harga (Rp) (Sebelum PPN)	3P Referensi	Harga (Rp) (Sebelum PPN)	4P Referensi	Harga (Rp) (Sebelum PPN)
TA10	32	TA10D2S0323TPE	9.615.200	TA10D3S0324TPE	9.817.630	TA10D4S0324TPE	10.122.000
	40	TA10D2S0403TPE	9.615.200	TA10D3S0404TPE	9.817.630	TA10D4S0404TPE	10.122.000
	50	TA10D2S0503TPE	9.615.200	TA10D3S0504TPE	9.817.630	TA10D4S0504TPE	10.122.000
	63	TA10D2S0633TPE	10.256.500	TA10D3S0634TPE	10.472.400	TA10D4S0634TPE	10.797.000
	80	TA10D2S0803TPE	10.400.000	TA10D3S0804TPE	10.577.220	TA10D4S0804TPE	10.905.000
	100	TA10D2S1003TPE	16.881.000	TA10D3S1004TPE	17.237.000	TA10D4S1004TPE	17.770.000
TA16	125			TA16D3S1254TPE	20.413.400	TA16D4S1254TPE	21.045.000
	160			TA16D3S1604TPE	23.312.500	TA16D4S1604TPE	24.033.500
TA25	200			TA25D3S2004TPE	32.064.100	TA25D4S2004TPE	33.056.000
	250			TA25D3S2504TPE	32.384.750	TA25D4S2504TPE	33.387.000
TA63	320			TA63D3S3204TPE	43.281.370	TA63D4S3204TPE	44.620.000
	400			TA63D3S4004TPE	44.700.000	TA63D4S4004TPE	46.079.000
	500			TA63D3S5004TPE	48.817.000	TA63D4S5004TPE	50.326.000
	630			TA63D3S6304TPE	50.280.500	TA63D4S6304TPE	51.836.000

TransferPacT Active Automatic ATS

Frame	Rating (Amps)	2P Referensi	Harga (Rp) (Sebelum PPN)	3P Referensi	Harga (Rp) (Sebelum PPN)	4P Referensi	Harga (Rp) (Sebelum PPN)
TA10	32	TA10D2L0323TPE	16.493.000	TA10D3L0324TPE	16.840.000	TA10D4L0324TPE	17.360.000
	40	TA10D2L0403TPE	16.842.900	TA10D3L0404TPE	17.206.500	TA10D4L0404TPE	17.730.000
	50	TA10D2L0503TPE	17.000.500	TA10D3L0504TPE	17.355.400	TA10D4L0504TPE	17.893.000
	63	TA10D2L0633TPE	17.931.000	TA10D3L0634TPE	18.308.500	TA10D4L0634TPE	18.875.000
	80	TA10D2L0803TPE	19.604.000	TA10D3L0804TPE	20.016.300	TA10D4L0804TPE	20.636.000
	100	TA10D2L1003TPE	19.760.000	TA10D3L1004TPE	20.175.200	TA10D4L1004TPE	20.800.000
TA16	125			TA16D3L1254TPE	23.472.000	TA16D4L1254TPE	24.200.000
	160			TA16D3L1604TPE	26.370.700	TA16D4L1604TPE	27.200.000
TA25	200			TA25D3L2004TPE	34.582.500	TA25D4L2004TPE	35.653.000
	250			TA25D3L2504TPE	34.930.300	TA25D4L2504TPE	36.009.000
TA63	320			TA63D3L3204TPE	47.007.500	TA63D4L3204TPE	48.451.000
	400			TA63D3L4004TPE	48.352.700	TA63D4L4004TPE	49.848.000
	500			TA63D3L5004TPE	50.770.770	TA63D4L5004TPE	52.340.000
	630			TA63D3L6304TPE	52.293.000	TA63D4L6304TPE	53.911.000
TA1A	800					TA1AD4L8004TPE	113.117.300
	1000					TA1AD4L10H4TPE	114.248.500
	1250					TA1AD4L12H4TPE	114.619.200
	1600					TA1AD4L16H4TPE	115.765.300



Barrier

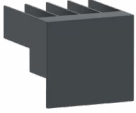

Shield

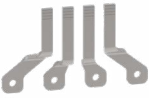

Bar



Function Modules



TPCCIF01



TPCOTH37



TPCCIF02



TPCCIF04



Auxiliary Contact

TransferPacT Automatic Transfer Switch

TransferPacT Automatic Aksesoris

Aksesori

Tipe Aksesoris	Deskripsi	Referensi	Harga (Rp) (Sebelum PPN)
Function Module	ModBus RS485	TPCCOM16	3.541.336
	Voluntary control	TPCDIO08	1.269.391
	24Vdc pulse	TPCDIO10	1.336.959
	24Vdc constant	TPCDIO11	1.280.911
	220Vac constant	TPCDIO13	1.322.892
	Dry contact	TPCDIO14	1.271.828
	Ext24VDC CAN	TPCDIO15	1.062.368
	GS delay Alarm	TPCDIO17	1.873.405
	LS AW output	TPCDIO05	1.306.609
	TI ST input	TPCDIO07	1.268.173
	Insulation Accessory	barrier for R2	TPSISO29
shield for R1		TPSISO30	246.346
shield for R2		TPSISO31	265.952
terminal shield for Frame 630A		TPSISO42	516.618
Interphase barriers for Frame 250A and 630A		TPSISO65	225.743
Insulating screen for Frame 250A		TPSISO66	373.285
Insulating screen for Frame 630A		TPSISO67	653.526
Connection Accessory	Bars for Ruby 1	TPSCON35	720.873
	Bars for Ruby 2	TPSCON36	689.193
Aux	Auxiliary contact for source position for Frame 100&160	TPSAUX32	484.385
	Auxiliary contact for OFF position for Frame 100&160	TPSAUX33	479.732
	auxiliary contact for source for Frame 250A, Frame 630A	TPSAUX43	306.382
	auxiliary contact for OFF for Frame 250A, Frame 630A	TPSAUX44	357.224
Display Module	External HMI	TPCCIF04	2.964.461
	LCD display	TPCCIF01	2.210.469
Spare parts	Accessory handle for Frame 250A and 630A	TPSOTH69	2.375.180



Smart Transfer and Reliable Performance

WOTPC Automatic Transfer Switch



Smart transfer of key power sources based on flexible and convenient control functions



Safely operation under extreme conditions due to the marvelous EMC (Electromagnetic Compatibility) feature



Reliable Performance brings to you safely operations – a better short-circuit performance



WOTPC Automatic Transfer Switch

Overview

WOTPC ATS (Automatic Transfer Switch) is a high-performance PC-Class transferring switch, especially suitable for commercial buildings, industries & infrastructures that require automatic switching of common and standby power sources, apt for Line - Line / Line - Generator / Generator - Generator applications.

Our ATS features a special contact structure and a new generation of solenoid operating coils that can withstand thousands of operating cycles without burning, pitting, or fusion welding. No daily contact maintenance is required, 100% of the rated current can be sustained without "contact" burning and can withstand short circuit current.

Our ATS has a sensible load security transfer for the delay transfer mode.

Norms

- IEC60947-6-1 Low-voltage switchgear and control equipment: multi-function electrical transfer switch (IEC certified).
- GB/T14048.11-2016 Low-voltage switchgear and control equipment: multi-function electrical transfer switch (CCC certified).



Transfer Switch Unit



Controller



Controller Cable

Product Information

WOTPC ATS consists of three parts:

- 1. Transfer Switch Unit,**
- 2. Controller, and**
- 3. Controller Cable.**

The transfer switch unit relates to the controller through its cable to realize the detection of the power supply. The controller automatically completes the transfer between the power supply through the set program.

Transfer Switch Unit

- Carry the primary loop current
- Short-circuit tolerance
- Mechanical interlocks provision to ensure that S1 and S2 power supplies do not run side by side
- Manual operation device is provided

Controller

- S1 and S2 power supply quality check
- Power transfer action when the power supply state exceeds the set threshold
- An electrical interlock and a logic protection circuit ensure that S1 and S2 power supplies do not run side by side
- Automatic/controller button transfer and the option to exit the controller's control
- Function of over voltage protection and can work normally for a long time
- Designed to use in the special environment

Controller Cable

- Used to realize the transfer function
- Electrical interlocking loops



WOTPC Automatic Transfer Switch

WOTPC Automatic Transfer Switch

Smart transfer and Reliable Performance

WOTPC Automatic transfer switch

- Smart transfer of key power sources based on flexible and convenient control functions
- Safely operation under extreme conditions due to the marvelous EMC (Electromagnetic Compatibility) feature
- Reliable Performance brings to you safely operations – a better short-circuit performance

Complete Assembly

Series	Rating (Amps)	Poles	Transfer Type	Wiring Method	Description	Referensi	Harga (Rp) (Sebelum PPN)
SIHAI	1000	4P	Delayed Transition	Vertical	WOTPC10004D5	OT10004D5VI	162.512.000
	1250				WOTPC12504D5	OT12504D5VI	162.512.000
	1600				WOTPC16004D5	OT16004D5VI	162.512.000
	2000				WOTPC20004D5	OT20004D5VI	162.512.000
	2500				WOTPC25004D5	OT25004D5VI	162.512.000
	3200				WOTPC32004D5	OT32004D5I	191.371.000
	4000				WOTPC40004D5	OT40004D5I	241.422.000

Aksesori

Deskripsi	Referensi	Harga (Rp) (Sebelum PPN)
Phase partition(Each)	W00T0001I	1.398.000
Extension harness(4m)	W00T0002I	3.744.000
Copper bar for vertical wiring method	W00T0003I	1.412.000



630A Extended Handle
GoPact MTS



160A Extended Handle
GoPact MTS



1250A Extended Handle
GoPact MTS



GoPact Manual Transfer Switch Complete Assembly & Aksesori

Typical composition of GoPact MTS

Accessories are part of the product delivery

Complete assembly consists of below components only:

- + 1 Manual Transfer Switch
 - + Inter-Phase Barrier
 - + Output Shorting Link
 - + Auxiliary Contact Kit
 - + Source Separator
 - + Terminal Shroud
 - + Open Execution Shaft
 - + Handle Kit / Handle
 - + Castell Type Lock*
- (* Need to buy separately (Optional))

Complete Assembly

Frame	Rating	Deskripsi	4P Referensi	Harga (Rp) (Sebelum PPN)
Direct Rotary Handle, 415VAC 50/60Hz				
100	63	Manual Transfer Switch 63 amps	GM10D4N0634BDE	POA
100	100	Manual Transfer Switch 100 amps	GM10D4N1004BDE	POA
Extended Rotary Handle, 415VAC 50/60Hz				
100	63	Manual Transfer Switch 63 amps	GM10D4N0634BEE	2.789.700
100	100	Manual Transfer Switch 100 amps	GM10D4N1004BEE	4.304.400
200	125	Manual Transfer Switch 125 amps	GM20D4N1254BEE	4.426.800
200	160	Manual Transfer Switch 160 amps	GM20D4N1604BEE	5.548.800
200	200	Manual Transfer Switch 200 amps	GM20D4N2004BEE	7.022.700
315	250	Manual Transfer Switch 250 amps	GM32D4N2504BEE	7.644.900
315	315	Manual Transfer Switch 315 amps	GM32D4N3154BEE	10.653.900
630	400	Manual Transfer Switch 400 amps	GM63D4N4004BEE	10.898.700
630	630	Manual Transfer Switch 630 amps	GM63D4N6304BEE	12.081.900
1000	800	Manual Transfer Switch 800 amps	GM1AD4N8004BEE	20.813.100
1000	1000	Manual Transfer Switch 1000 amps	GM1AD4N10H4BEE	32.935.800
2000	1250	Manual Transfer Switch 1250 amps	GM2AD4N12H4BEE	34.654.500
2000	1600	Manual Transfer Switch 1600 amps	GM2AD4N16H4BEE	45.548.100
2000	2000	Manual Transfer Switch 2000 amps	GM2AD4N20H4BEE	74.995.500

Aksesori

Frame	Rating	4P Referensi	Harga (Rp) (Sebelum PPN)
Castell Type Lock			
100	63/100	GMSOTHCTL01A	1.650.000
200/315/630/1000	125/1000	GMSOTHCTL25A	1.833.400
2000	1250/2000	GMSOTHCTL06A	1.994.000

GoPact Manual Transfer Switch

Spare parts

Spare Parts

Frame	Rating	Deskripsi	4P Referensi	Harga (Rp) (Sebelum PPN)
Handle Kit				
100	63/100	Operating handle, Frame 1, front rotary handle, IP2x	GMSOTHOHK01	398.000
200	125/200	Operating handle, Frame 2, front rotary handle, IP2x	GMSOTHOHK02	681.000
315	250/315	Operating handle, Frame 3, front rotary handle, IP2x	GMSOTHOHK03	894.000
630	400/630	Operating handle, Frame 4, front rotary handle, IP2x	GMSOTHOHK04	921.400
1000	630/1000	Operating handle, Frame 5, front rotary handle, IP2x	GMSOTHOHK05	1.444.500
2000	1250/2000	Operating handle, Frame 6, front rotary handle, IP2x	GMSOTHOHK06	1.579.000
Auxiliary Contact Kit				
100	63/100	Frame 1, 2 NO/NC contacts, ON/OFF indication	GMSAUXCK01	322.000
200	125/200	Frame 2, 2 NO/NC contacts, ON/OFF indication	GMSAUXCK02	400.000
315	250/315	Frame 3, 2 NO/NC contacts, ON/OFF indication	GMSAUXCK03	395.000
630	400/630	Frame 4, 2 NO/NC contacts, ON/OFF indication	GMSAUXCK04	535.000
1000	630/1000	Frame 5, 2 NO/NC contacts, ON/OFF indication	GMSAUXCK05	558.000
2000	1250/2000	Frame 6, 2 NO/NC contacts, ON/OFF indication	GMSAUXCK06	581.000
Open Execution shaft				
100	63/100	for operating handle, Frame 1, shaft length 88.5mm	GMSOTHOES01	94.000
200	125/200	for operating handle, Frame 2, shaft length 113mm	GMSOTHOES02	98.000
315	250/315	for operating handle, Frame 3, shaft length 108mm	GMSOTHOES03	102.000
630	400/630	for operating handle, Frame 4, shaft length 106mm	GMSOTHOES04	112.000
1000	630/1000	for operating handle, Frame 5, shaft length 112mm	GMSOTHOES05	150.000
2000	1250/2000	for operating handle, Frame 6, shaft length 75-175mm	GMSOTHOES06	307.000
Terminal Shroud				
100	63/100	Terminal shrouds, Frame 1, set of 2	GMSISOTS01	92.000
200	125/200	Terminal shrouds, Frame 2, set of 2	GMSISOTS02	130.000
315	250/315	Terminal shrouds, Frame 3, set of 2	GMSISOTS03	154.000
630	400/630	Terminal shrouds, Frame 4, set of 2	GMSISOTS04	237.000
1000	630/1000	Terminal shrouds, Frame 5, set of 2	GMSISOTS05	261.000
2000	1250/1600	Terminal shrouds, Frame 6, set of 2	GMSISOTS06	268.000
2000	2000	Terminal shrouds, Frame 6, set of 2	GMSISOTS0620H	334.000
Output Shorting Link				
100	63/100	Output shorting link, Frame 1, top side	GMSCONOSL01T	214.000
100	63/100	Output shorting link, Frame 1, bottom side	GMSCONOSL01B	214.000
200	125/200	Output shorting link, Frame 2	GMSCONOSL02200	354.000
315	250/315	Output shorting link, Frame 3	GMSCONOSL03315	1.052.000
630	400/630	Output shorting link, Frame 4	GMSCONOSL04630	1.500.000
1000	630/1000	Output shorting link, Frame 5	GMSCONOSL0510H	2.777.000
2000	1250	Output shorting link, Frame 6	GMSCONOSL0612H	5.557.000
2000	1600	Output shorting link, Frame 6	GMSCONOSL0616H	7.595.000
2000	2000	Output shorting link, Frame 6	GMSCONOSL0620H	11.020.400
Inter-phase barrier				
200	125/200	Interphase barriers, Frame 2, set of 6	GMSISOPB02	236.000
315	250/315	Interphase barriers, Frame 3, set of 6	GMSISOPB03	326.400
630	400/630	Interphase barriers, Frame 4, set of 6	GMSISOPB04	358.000
1000	630/1000	Interphase barriers, Frame 5, set of 6	GMSISOPB05	393.000
2000	1250/1600	Interphase barriers, Frame 6, set of 6	GMSISOPB06	410.000
2000	2000	Interphase barriers, Frame 6, set of 6	GMSISOPB0620H	427.000
Source separator				
200	125/200	Source separators, Frame 2	GMSISOSS02	109.000
315	250/315	Source separators, Frame 3	GMSISOSS03	117.000
630	400/630	Source separators, Frame 4	GMSISOSS04	128.000
1000	630/1000	Source separators, Frame 5	GMSISOSS05	148.000
2000	1250/1600	Source separators, Frame 6	GMSISOSS06	277.000
2000	2000	Source separators, Frame 6	GMSISOSS0620H	357.000





Life Is On

Schneider
Electric

Koreksi Faktor Daya

Peralatan dan Koreksi Faktor Daya	10-3
Kegunaan dan Pembacaan Referensi	10-3
Cara Menghitung Daya Reaktif	10-4
Tabel Cos ϕ	10-5
Kapasitor	10-6
Spesifikasi Teknis	10-6
Pemasangan	10-7
Kapasitor EasyLogic PFC (Standard Duty)	10-8
Kapasitor PowerLogic PFC (Heavy Duty)	10-9
Detuned Reactor	10-10
Detuned Reactor PowerLogic PFC & Asosiasi dengan Kapasitor PowerLogic PFC	10-10
Detuned Reactor EasyLogic PFC & Asosiasi dengan Kapasitor EasyLogic PFC	10-11
Regulator dan Kelengkapan	10-12
Kontaktor Kapasitor	10-13
Pemutus Tenaga	10-14

Koreksi Faktor Daya

Kegunaan dan Pembacaan Referensi

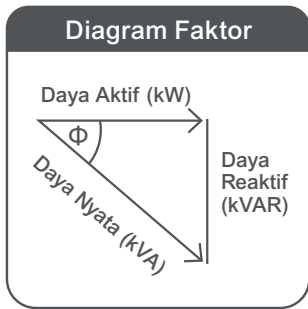

■ Aplikasi

PLN membebankan biaya kelebihan pemakaian KVARh pada pelanggan industri, jika rata-rata faktor dayanya ($\cos \theta$) kurang dari 0.85. Untuk memperbaiki faktor daya sehingga tidak membayar denda, adalah aplikasi dari kapasitor PowerLogic PFC / EasyLogic PFC dari Schneider.

Selain itu, pemasangan kapasitor dapat menghindari :

- Trafo kelebihan beban (*overload*), sehingga memberikan tambahan daya yang tersedia.
- Voltage drop pada titik ujung instalasi.
- Kenaikan arus/suhu pada kabel, sehingga mengurangi kerugian energi yang terbuang menjadi panas.
- dll.

Untuk pemasangan tumpuk kapasitor (Capasitor bank) diperlukan :

- Kapasitor, dengan jenis yang cocok dengan kondisi jaringan.
- Regulator, untuk pengaturan daya tumpuk kapasitor (kapasitor bank) otomatis.
- Kontaktor, untuk switching daya ke kapasitor.
- Pemutus Tenaga, untuk proteksi termal dan hubung singkat tumpuk kapasitor.

■ Berikut menunjukkan langkah dalam memilih kapasitor Schneider

Konstruksi	Tipe	Keterangan	Digunakan untuk	Kondisi Maksimal
	EasyLogic PFC	Kapasitor Standard untuk jaringan tanpa (sedikit) harmonik (tersedia hanya di silinder box)	<ul style="list-style-type: none"> • Jaringan yang jarang terdapat beban non-linear • Kemungkinan arus lebih (<i>overcurrent</i>), I_{max} • Temperatur kerja maksimal • Frekuensi <i>switching</i> normal • Nilai Total Harmonik THD(i) / THD(u) 	<ul style="list-style-type: none"> NLL < 10% 1.5 I_n 55°C (Class D) 5000/ tahun <5% / <3%
	PowerLogic PFC	Kapasitor Heavy-Duty untuk jaringan dengan polusi harmonik (tersedia di silinder atau box)	<ul style="list-style-type: none"> • Jaringan yang terdapat sedikit beban non-linear • Kemungkinan arus lebih (<i>overcurrent</i>), I_{max} • Temperatur kerja maksimal • Frekuensi <i>switching</i> normal • Nilai Total Harmonik THD(i) / THD(u) 	<ul style="list-style-type: none"> NLL < 20% 1.8 I_n 55°C (Class D) 7000/ tahun <8% / <5%
	PowerLogic PFC + DR	Kapasitor heavy-duty (tersedia di silinder atau box) + Detuned Reactor	<ul style="list-style-type: none"> • Jaringan dengan beban non-linear sangat banyak • kemungkinan arus lebih (<i>overcurrent</i>), I_{max} • Temperatur kerja maksimal • Frekuensi <i>switching</i> normal • Nilai Total Harmonik THD(i) / THD(u) 	<ul style="list-style-type: none"> NLL < 30% 1.8 I_n 55°C (Class D) 7000/ tahun <20% / <5%

Catatan :

- NLL = Gh / Sn ; Gh : Total daya peralatan yang menghasilkan harmonik, Sn : Total daya trafo
- Kondisi temperatur yang baik diharapkan sekitar 35° C untuk kapasitor yang lebih tahan lama
- THD(i) / THD(u) diukur pada sisi sekunder trafo saat full load. Idealnya, pengukuran dilakukan sebelum dan sesudah pemasangan kapasitor. Hasil pengukuran sebaiknya dalam satu range tipe kapasitor.
Contoh: Sebelum kapasitor terpasang, THD(i) = 5.5%. Sesudah dipasang Kapasitor Hduty, THD(i) = 7.5%, sehingga masih dalam satu range harmonik untuk Hduty (5%<THD(i)<8%).
- Untuk alasan performa yang lebih baik, pemilihan kapasitor dapat didasarkan pada THD tertinggi.
Contoh: Hasil pengukuran sebelum pemasangan kapasitor adalah THD(i) = 6%, THD(u) = 2.5%, maka kapasitor Hduty lebih menjadi pertimbangan.
- Saat kondisi dimana jaringan memiliki THD(i) > 20% dan THD(v) >5%, hubungi kami di 1500055

■ Pembacaan Referensi

Contoh : BLRCH104A125B40

(PowerLogic PFC HeavyDuty, 400V, 10 kVar pada 50 Hz dan 12.5 kVar pada 60 Hz)

BLR	C	H	104A	125B	40
	Konstruksi	Tipe	Daya	Daya	Tegangan
	C: Can B: Box	S: SDuty H: HDuty	Pada 50 Hz 10.4 kVar pada 50 Hz A: 50 Hz	Pada 60 Hz 12.5 kVar pada 60 Hz B: 60 Hz	40: 400 V 52: 525 V

Sebelum Kompensasi

Energi reaktif seluruhnya disuplai oleh trafo

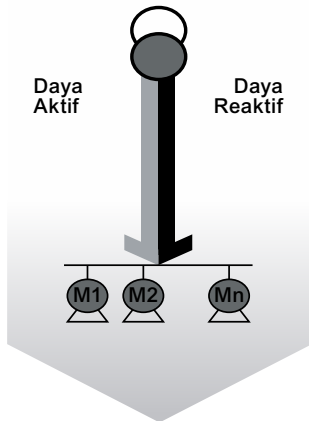
**Sesudah Kompensasi**

Energi reaktif sebagian/ seluruhnya disuplai oleh tumpuk kapasitor

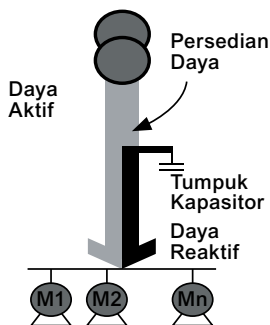

Koreksi Faktor Daya

Cara Menghitung Daya Reaktif

Menghitung daya reaktif yang diperlukan untuk suatu sistem kompensasi.

3 cara termudah untuk menentukan Daya Kapasitor yang dibutuhkan (Qc)

1. Metode Sederhana

Metode ini digunakan agar dengan cepat bisa menentukan Qc.

Angka yang harus diingat : **0.84** untuk **setiap kW beban**.

Yaitu diambil dari :

Perkiraan rata-rata faktor daya suatu instalasi : 0.65

Faktor daya yang diinginkan : 0.95

Maka dari tabel $\cos \phi$ didapat angka : **0.84**

Contoh

Untuk menghindari denda PLN suatu instalasi dengan beban 100 kW memerlukan Daya Reaktif (Qc) sebesar:

$$Qc = 0.84 \times 100 \text{ kW} = 84 \text{ kVAR}$$

2. Metode Kwitansi PLN

Metode ini memerlukan data dari kwitansi PLN selama satu periode (misalnya 1 tahun).

Kemudian data penghitungan diambil dari pembayaran denda kvarh yang *tertinggi*.

Data lain yang diperlukan adalah jumlah waktu pemakaian.

Contoh

Suatu pabrik yang beroperasi 8 jam/hari, membayar denda pemakaian kvarh tertinggi pada tahun yang lalu untuk 63504 kvarh. Maka diperlukan capacitor bank dengan daya:

$$Qc = \frac{\text{kvarh tertinggi}}{\text{Waktu Pemakaian}} \quad \text{kVAR} = \frac{63504 \text{ kvarh}}{8 \text{ jam} \times 30 \text{ hari / bulan}} = 265 \text{ kVAR}$$

3. Metode Cos ϕ

Metode ini menggunakan Tabel Cos ϕ ([lihat 10-5](#))

Data yang diperlukan adalah: Daya Beban total dan faktor Daya (cos ϕ).

Contoh

Sebuah instalasi pabrik memiliki faktor daya : 0.70 untuk beban puncak 600 kW.

Untuk meningkatkan faktor daya menjadi 0.93 diperlukan daya kapasitor sebesar :

Dari Tabel Cos ϕ ([lihat 10-5](#)) didapat angka : 0.62

Maka Daya Reaktif yang diperlukan:

$$Qc = 0.62 \times 600 \text{ kW} = 372 \text{ kvar}$$

Jika tidak memiliki data untuk daya beban dapat juga dihitung menggunakan rumus:

$$\text{Daya Beban} = V \times I \cos \phi \times \sqrt{3}$$

V = Tegangan Jaringan/Instalasi

I = Arus Jaringan/Instalasi

Cos ϕ = Faktor Daya Jaringan/Instalasi

Koreksi Faktor Daya

Tabel Cos φ

■ Tabel cos φ, guna mendapatkan faktor pengali setiap kW beban

Sebelum Kompensasi		Setelah Kompensasi (Faktor daya yang diinginkan)															
Cos φ	tg φ	0.85	0.86	0.87	0.88	0.89	0.9	0.91	0.92	0.93	0.94	0.95	0.96	0.97	0.98	0.99	1.00
0.40	2.29	1.67	1.70	1.72	1.75	1.78	1.81	1.84	1.87	1.90	1.93	1.96	2.00	2.04	2.09	2.15	2.29
0.41	2.22	1.60	1.63	1.66	1.68	1.71	1.74	1.77	1.80	1.83	1.86	1.90	1.93	1.97	2.02	2.08	2.22
0.42	2.16	1.54	1.57	1.59	1.62	1.65	1.68	1.71	1.73	1.77	1.80	1.83	1.87	1.91	1.96	2.02	2.16
0.43	2.10	1.48	1.51	1.53	1.56	1.59	1.62	1.64	1.67	1.70	1.74	1.77	1.81	1.85	1.90	1.96	2.10
0.44	2.04	1.42	1.45	1.47	1.50	1.53	1.56	1.59	1.61	1.65	1.68	1.71	1.75	1.79	1.84	1.90	2.04
0.45	1.98	1.36	1.39	1.42	1.44	1.47	1.50	1.53	1.56	1.59	1.62	1.66	1.69	1.73	1.78	1.84	1.98
0.46	1.93	1.31	1.34	1.36	1.39	1.42	1.45	1.47	1.50	1.54	1.57	1.60	1.64	1.68	1.73	1.79	1.93
0.47	1.88	1.26	1.28	1.31	1.34	1.37	1.39	1.42	1.45	1.48	1.52	1.55	1.59	1.63	1.67	1.74	1.88
0.48	1.83	1.21	1.23	1.26	1.29	1.32	1.34	1.37	1.40	1.43	1.46	1.50	1.54	1.58	1.62	1.69	1.83
0.49	1.78	1.16	1.19	1.21	1.24	1.27	1.29	1.32	1.35	1.38	1.42	1.45	1.49	1.53	1.58	1.64	1.78
0.50	1.73	1.11	1.14	1.17	1.19	1.22	1.25	1.28	1.31	1.34	1.37	1.40	1.44	1.48	1.53	1.59	1.73
0.51	1.69	1.07	1.09	1.12	1.15	1.17	1.20	1.23	1.26	1.29	1.32	1.36	1.39	1.44	1.48	1.54	1.69
0.52	1.64	1.02	1.05	1.08	1.10	1.13	1.16	1.19	1.22	1.25	1.28	1.31	1.35	1.39	1.44	1.50	1.64
0.53	1.60	0.98	1.01	1.03	1.06	1.09	1.12	1.14	1.17	1.20	1.24	1.27	1.31	1.35	1.40	1.46	1.60
0.54	1.56	0.94	0.97	0.99	1.02	1.05	1.07	1.10	1.13	1.16	1.20	1.23	1.27	1.31	1.36	1.42	1.56
0.55	1.52	0.90	0.93	0.95	0.98	1.01	1.03	1.06	1.09	1.12	1.16	1.19	1.23	1.27	1.32	1.38	1.52
0.56	1.48	0.86	0.89	0.91	0.94	0.97	1.00	1.02	1.05	1.08	1.12	1.15	1.19	1.23	1.28	1.34	1.48
0.57	1.44	0.82	0.85	0.87	0.90	0.93	0.96	0.99	1.02	1.05	1.08	1.11	1.15	1.19	1.24	1.30	1.44
0.58	1.40	0.78	0.81	0.84	0.86	0.89	0.92	0.95	0.98	1.01	1.04	1.08	1.11	1.15	1.20	1.26	1.40
0.59	1.37	0.75	0.78	0.80	0.83	0.86	0.88	0.91	0.94	0.97	1.01	1.04	1.08	1.12	1.17	1.23	1.37
0.60	1.33	0.71	0.74	0.77	0.79	0.82	0.85	0.88	0.91	0.94	0.97	1.00	1.04	1.08	1.13	1.19	1.33
0.61	1.30	0.68	0.71	0.73	0.76	0.79	0.81	0.84	0.87	0.90	0.94	0.97	1.01	1.05	1.10	1.16	1.30
0.62	1.27	0.65	0.67	0.70	0.73	0.75	0.78	0.81	0.84	0.87	0.90	0.94	0.97	1.01	1.06	1.12	1.27
0.63	1.23	0.61	0.64	0.67	0.69	0.72	0.75	0.78	0.81	0.84	0.87	0.90	0.94	0.98	1.03	1.09	1.23
0.64	1.20	0.58	0.61	0.63	0.66	0.69	0.72	0.74	0.77	0.81	0.84	0.87	0.91	0.95	1.00	1.06	1.20
0.65	1.17	0.55	0.58	0.60	0.63	0.66	0.68	0.71	0.74	0.77	0.81	0.84	0.88	0.92	0.97	1.03	1.17
0.66	1.14	0.52	0.54	0.57	0.60	0.63	0.65	0.68	0.71	0.74	0.78	0.81	0.85	0.89	0.94	1.00	1.14
0.67	1.11	0.49	0.51	0.54	0.57	0.60	0.62	0.65	0.68	0.71	0.75	0.78	0.82	0.86	0.90	0.97	1.11
0.68	1.08	0.46	0.48	0.51	0.54	0.57	0.59	0.62	0.65	0.68	0.72	0.75	0.79	0.83	0.88	0.94	1.08
0.69	1.05	0.43	0.46	0.48	0.51	0.54	0.56	0.59	0.62	0.65	0.69	0.72	0.76	0.80	0.85	0.91	1.05
0.70	1.02	0.40	0.43	0.45	0.48	0.51	0.54	0.56	0.59	0.62	0.66	0.69	0.73	0.77	0.82	0.88	1.02
0.71	0.99	0.37	0.40	0.43	0.45	0.48	0.51	0.54	0.57	0.60	0.63	0.66	0.70	0.74	0.79	0.85	0.99
0.72	0.96	0.34	0.37	0.40	0.42	0.45	0.48	0.51	0.54	0.57	0.60	0.64	0.67	0.71	0.76	0.82	0.96
0.73	0.94	0.32	0.34	0.37	0.40	0.42	0.45	0.48	0.51	0.54	0.57	0.61	0.64	0.69	0.73	0.79	0.94
0.74	0.91	0.29	0.32	0.34	0.37	0.40	0.42	0.45	0.48	0.51	0.55	0.58	0.62	0.66	0.71	0.77	0.91
0.75	0.88	0.26	0.29	0.32	0.34	0.37	0.40	0.43	0.46	0.49	0.52	0.55	0.59	0.63	0.68	0.74	0.88
0.76	0.86	0.24	0.26	0.29	0.32	0.34	0.37	0.40	0.43	0.46	0.49	0.53	0.56	0.60	0.65	0.71	0.86
0.77	0.83	0.21	0.24	0.26	0.29	0.32	0.34	0.37	0.40	0.43	0.47	0.50	0.54	0.58	0.63	0.69	0.83
0.78	0.80	0.18	0.21	0.24	0.26	0.29	0.32	0.35	0.38	0.41	0.44	0.47	0.51	0.55	0.60	0.66	0.80
0.79	0.78	0.16	0.18	0.21	0.24	0.26	0.29	0.32	0.35	0.38	0.41	0.45	0.48	0.53	0.57	0.63	0.78
0.80	0.75	0.13	0.16	0.18	0.21	0.24	0.27	0.29	0.32	0.35	0.39	0.42	0.46	0.50	0.55	0.61	0.75
0.81	0.72	0.10	0.13	0.16	0.18	0.21	0.24	0.27	0.30	0.33	0.36	0.40	0.43	0.47	0.52	0.58	0.72
0.82	0.70	0.08	0.10	0.13	0.16	0.19	0.21	0.24	0.27	0.30	0.34	0.37	0.41	0.45	0.49	0.56	0.70
0.83	0.67	0.05	0.08	0.11	0.13	0.16	0.19	0.22	0.25	0.28	0.31	0.34	0.38	0.42	0.47	0.53	0.67
0.84	0.65	0.03	0.05	0.08	0.11	0.13	0.16	0.19	0.22	0.25	0.28	0.32	0.35	0.40	0.44	0.50	0.65
0.85	0.62	0.00	0.03	0.05	0.08	0.11	0.14	0.16	0.19	0.22	0.26	0.29	0.33	0.37	0.42	0.48	0.62
0.86	0.59		0.00	0.03	0.05	0.08	0.11	0.14	0.17	0.20	0.23	0.26	0.30	0.34	0.39	0.45	0.59
0.87	0.57			0.00	0.03	0.05	0.08	0.11	0.14	0.17	0.20	0.24	0.28	0.32	0.36	0.42	0.57
0.88	0.54				0.00	0.03	0.06	0.08	0.11	0.14	0.18	0.21	0.25	0.29	0.34	0.40	0.54
0.89	0.51					0.00	0.03	0.06	0.09	0.12	0.15	0.18	0.22	0.26	0.31	0.37	0.51
0.90	0.48						0.00	0.03	0.06	0.09	0.12	0.16	0.19	0.23	0.28	0.34	0.48

Standar :
IEC 60831-1
IEC 60831-2 (internasional)



EasyLogic PFC
10≤kVar≤25



PowerLogic PFC Xtreme
Heavy Duty
25≤kVar≤50



PowerLogic PFC
10≤kVar≤50

Kapasitor

Spesifikasi Teknik

Desain internal kapasitor adalah tiga (3) fasa untuk berbagai aplikasi di industri, gedung, dan lain sebagainya. Beberapa fitur keselamatan yang dimiliki antara lain:

- Self-healing
- Pressure-sensitive-disconnector
- Discharge service

Type	EasyLogic PFC (Standard Duty)	PowerLogic PFC (Heavy Duty)	PowerLogic PFC Xtreme (Heavy Duty)
Konstruksi	Aluminium	Aluminium	Enclosure lapis baja (steel)
Dielektrik	Film polypropylene berlapis metal dengan campuran Zn/Alloy	Film polypropylene berlapis metal dengan campuran Zn/Alloy dengan spesial profil lapisan metal dan pemotongan	Film polypropylene berlapis metal dengan campuran Zn/Alloy dengan spesial profil lapisan metal dan pemotongan
Bahan Pengisi	Non-PCB, Biodegradable soft resin	Non-PCB, sticky (dry) Biodegradable resin	Non-PCB, sticky (dry) Biodegradable resin
Pemasangan	Tegak Lurus (vertikal)	Tegak lurus, Horizontal	Tegak lurus, Horizontal
Proteksi	IP 20, Indoor	IP 20, Indoor	IP 20, Indoor

PowerLogic PFC Box

Type	W1 (mm ²)	W1 (mm ²)	W3 (mm ²)	H (mm)	D (mm)	Berat (kg)
GB	309	289	259	355	153	7.5
IB	309	289	259	497	224	10

PowerLogic PFC

Type	Diameter d (mm)	Tinggi h (mm)	Tinggi h + t (mm)	Berat (kg)
MC	75	203	233	1.2
NC	75	278	308	1.2
SC	90	278	308	2.3
RC	90	212	242	1.6
TC	116	212	242	2.5
YC	136	278	321	5.3

Catatan : Untuk detail spesifikasi teknis dan manual pemasangan silakan menghubungi kami

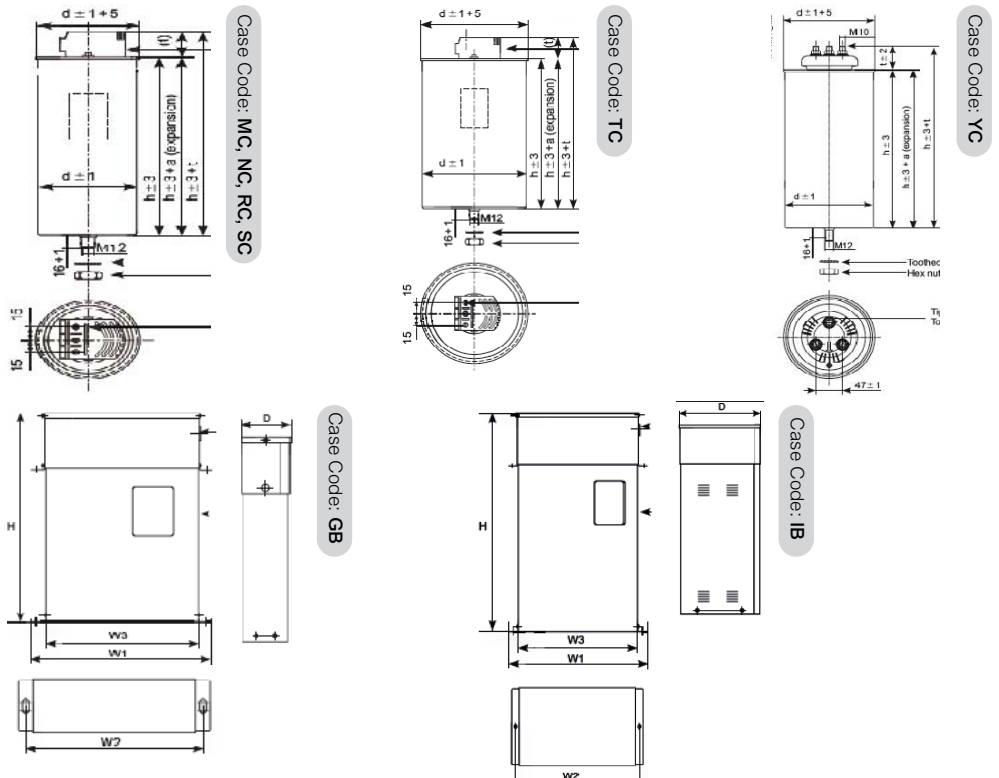

Kapasitor Pemasangan



Untuk detail pemasangan silakan menghubungi kami

■ Aturan Umum

- 1 Instalasi dalam ruangan pada kedudukan yang kuat.
- 2 Temperatur ruangan di sekitar kapasitor diharapkan tidak melebihi 35°C selama setahun, 45°C selama 24 jam dan maksimum 55°C (berdasarkan IEC 60831 untuk -25/D kategori temperatur).
- 3 Menjaga jarak minimal sebesar 30 mm antar kapasitor dan 30 mm antara kapasitor dan panel untuk sirkulasi udara yang lebih baik.
- 4 Kapasitor berada dalam area yang bebas debu (material-material konduktor) dan jauh dari sumber panas.
- 5 Menjaga jarak bagian atas kapasitor minimal sebesar 30 mm.
- 6 Menggunakan kontaktor kapasitor atau kontaktor standard dengan koil induktor yang diseri untuk mengurangi inrush current.
- 7 Pastikan tidak ada benda yang menghalangi terminal kapasitor, agar *Pressure sensitive disconnecter* bekerja sempurna.
- 8 Untuk panel kapasitor, harus dilengkapi dengan ventilasi yang baik dan sirkulasi dari bawah ke atas.
- 9 Bila menggunakan Detuned Reactor, perlu dibuatkan ruangan terpisah dengan kapasitor.

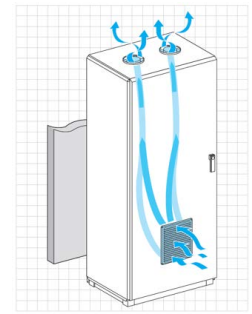

Panel Kapasitor tanpa Detuned Reactor

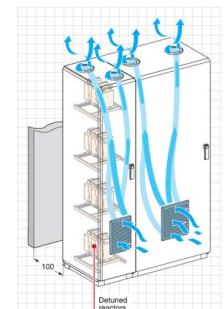

Panel Kapasitor dengan Detuned Reactor

■ Aturan Umum Kelistrikan

- 1 Pastikan tidak ada kabel yang bersentuhan antar fasa, atau material konduktor yang memungkinkan hubung singkat antar terminal.
- 2 Pastikan bodi kapasitor terhubung pentanahan (grounding).
- 3 Menjaga jarak kelistrikan antara fasa minimal 30 mm.
- 4 Rekomendasi penampang kabel.

Rating kVAR	Al (mm ²)	Cu (mm ²)	Ukuran sepatu kabel (Cable lug)
2.5	1.5	1	M5/M6/M8 tipe pin, garpu atau ring bergantung pada terminal komponen
5	1.5	1	
7.5	4	2.5	
10	6	4	
12.5	6	4	
15	6	6	
20	10	10	M5/M6/M8 tipe garpu atau ring
25	16	16	
30	25	16	
40	35	25	
50	35	35	
75	2 x 35	2 x 35	
100	2 x 50	2 x 50	

- 5 Secara berkala, perlu dilakukan pengecekan harmonik, kapasitansi kapasitor, temperatur dan terminasi.
- 6 Beberapa Kombinasi Switching pada controller.
 - 1.1.1.1.1... 1.1.2.4.4.4...
 - 1.1.2.2.2.2... 1.2.3.4.4.4...
 - 1.2.2.2.2.2... 1.2.4.4.4.4...
 - 1.1.2.3.3.3... 1.2.3.6.6.6...
 - 1.2.3.3.3.3... 1.2.4.8.8.8...



Scan untuk
Data Teknis



Kapasitor
EasyLogic PFC

Kapasitor

Kapasitor EasyLogic PFC (Standard Duty)

Kapasitor Untuk Jaringan Normal

■ Aplikasi

Kapasitor jenis standar sangat tepat digunakan pada jaringan yang tidak terlalu terpolusi oleh harmonik (NLL < 10%). NLL = Gh/ Sn. Gh : Total Power Non-Linear Load ; Sn : Installed transformer rating.

Karakteristik Teknis

- Standar : IEC 60831-1/-2
- Toleransi kelebihan tegangan: 1.1 x Un (8 Jam / hari)
- Toleransi kelebihan arus : 1.5 x In
- Tegangan : 400 Vac
- Frekuensi : 50 / 60 Hz
- Arus Inrush Puncak : 200 x In
- Suhu : -25° - 55°C
- Pemasangan : Tegak Lurus, Indoor
- Toleransi kapasitansi : -5%, +10%

■ Tegangan Jaringan : 400 V

Daya Reaktif (kvar)			Kode dimensi	Referensi	Harga (Rp) (Sebelum PPN)	SS
380 V	400 V	415 V				
9.4	10.4	11.2	MC	BLRCS104A125B40	1.890.000	1
11.3	12.5	13.5	NC	BLRCS125A150B40	2.324.000	2
13.5	15	16.1	NC	BLRCS150A180B40	2.376.000	1
18.1	20	21.5	SC	BLRCS200A240B40	2.844.000	1
22.6	25	26.9	SC	BLRCS250A300B40	3.286.000	1



Scan untuk
Data Teknis



Kapasitor
PowerLogic PFC



Scan untuk
Data Teknis



Kapasitor PowerLogic PFC
Xtreme Heavy Duty

Kapasitor

Kapasitor PowerLogic PFC (Heavy Duty)

Kapasitor Untuk Jaringan Berharmonik

■ Aplikasi

Kapasitor jenis Heavy duty didesain khusus untuk jaringan 380/400/415 V, yang terpolusi oleh Harmonik. Tersedia dalam 2 pilihan bentuk : Tabung silinder dan Box.

Karakteristik Teknis

- Standar : IEC 60831-1/-2
- Toleransi kelebihan tegangan: $1.1 \times U_n$ (8 Jam/hari)
- Toleransi kelebihan arus : $1.8 \times I_n$
- Tegangan : 400 Vac
- Frekuensi : $250 \times I_n$
- Arus Inrush Puncak : $-25^\circ - 55^\circ\text{C}$
- Suhu : $-25^\circ - 55^\circ\text{C}$
- Pemasangan : Tegak Lurus (Can/Box) atau mendatar (Can), Indoor
- Toleransi kapasitansi : $-5\%, +10\%$

■ PowerLogic Can (Hduty), Tegangan Jaringan 400 V

Daya Reaktif (kVAR)			Kode dimensi	Referensi	Harga (Rp) (Sebelum PPN)	SS
380 V	400 V	415 V				
9.4	10.4	11.2	MC	BLRCH104A125B40	2.531.000	1
11.3	12.5	13.5	RC	BLRCH125A150B40	3.010.000	2
13.5	15	16.1	RC	BLRCH150A180B40	3.080.000	2
18.1	20	21.5	TC	BLRCH200A240B40	3.783.000	1
22.6	25	26.9	TC	BLRCH250A300B40	4.209.000	1
45.1	50	53.8	YC	BLRCH500A000B40	8.225.000	1

■ PowerLogic PFC Xtreme (Hduty), Tegangan Jaringan 400 V

Daya Reaktif (kVAR)			Kode dimensi	Referensi	Harga (Rp) (Sebelum PPN)	SS
380 V	400 V	415 V				
45.1	50	53.8	IB	BLRBH500A000B40	12.145.000	2



Scan untuk Data Teknis



Detuned Reactor

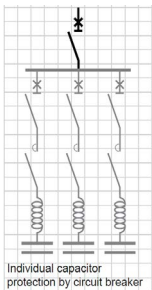

Detuned Reactor

Detuned Reactor PowerLogic PFC & Asosiasi dengan Kapasitor PowerLogic PFC

Aplikasi

Jika polusi harmonik sangat tinggi ($20\% < Gh/Sn < 50\%$), maka harus menggunakan detuned reactor yang dirangkai seri dengan kapasitor tipe Standard atau Heavy Duty.



PENTING

- Pemasangan Detuned Reactor tidak dapat menghilangkan/menurunkan level harmonik di jaringan.
- Tujuan pemasangan Detuned Reactor adalah melindungi kapasitor dari kerusakan akibat kelebihan tegangan/arus karena harmonik yang terlalu tinggi sehingga usia pakai kapasitor akan lebih panjang.
- Instalasi kapasitor bank dengan detuned reactor perlu menggunakan kabel tahan panas hingga 100°C

Daya Reaktif (kVAR)	Induktansi (mH)	Referensi	Harga (Rp) <i>(Sebelum PPN)</i>	SS
Tegangan Jaringan 400 V, 50 Hz Detuned Reactor Tuning Order 3.8 / Relative Impedance 7%				
12.5	2.987	LVR07125A40T	12.938.000	1
25	1.449	LVR07250A40T	14.647.000	2
50	0.75	LVR07500A40T	17.512.000	2
100	0.375	LVR07X00A40T	25.502.000	1

Catatan : Untuk kompensasi tetap, Detuned Reactor bisa disambungkan ke beberapa tumpuk kapasitor (capacitor bank) yang membentuk daya total sesuai dengan daya Detuned Reactor.

Contoh: Detuned Reactor 100 kvar disambungkan ke dua bank yang masing-masing memiliki daya : 50 kvar.

Tabel Asosiasi Detuned Reactor + Kapasitor PowerLogic PFC Heavy Duty

Daya Reaktif (kVAR)			Kode Dimensi	Referensi	Harga (Rp) <i>(Sebelum PPN)</i>	SS
415 V	480 V	525 V				
PowerLogic PFC Hduty, Tegangan kapasitor : 525 V						
12.5	16.7	20	TC	BLRCH200A240B52	3.726.000	1
15,6	20,9	25	TC	BLRCH250A300B52	4.469.000	2
25	33,4	40	XC	BLRCH400A480B52	6.433.000	1
PowerLogic PFC Xtreme Hduty, Tegangan Kapasitor : 525 V						
25	33,4	40	IB	BLRBH400A480B52	9.970.000	2

Kombinasi PowerLogic PFC

Effective Power @400V (kVAR)	QN @ 525V (kVAR)	Kapasitor		7% fr=190Hz D.R Ref.	Switching: Contactor Ref. Protection	Breaker EasyPact CVS (Icu: 36kA)
		Refrensi	Tipe Kapasitor			
Untuk Tegangan Jaringan 400V, 50Hz Tegangan Kapasitor 525V / 7% Filter						
12.5	20	BLRCH200A240B52 x 1	Can	LVR07125A40T x 1	LC1D18	LV429636
25	40	BLRCH200A240B52 x 2	Can	LVR07250A40T x 1	LC1D38	LV429633
		BLRBH400A480B52 x 1	Box			
50	80	BLRCH200A240B52 x 2	Can	LVR07500A40T x 1	LC1D95	LV429630
		BLRBH400A480B52 x 2	Box			
100	160	BLRCH400A480B52 x 4	Can	LVR07X00A40T x 1	LC1G185	LV431631
		BLRBH400A480B52 x 4	Box			

Paket Kombinasi Kapasitor PowerLogic PFC & Detuned Reactor PowerLogic PFC



Effective Power @400V (kVAR)	QN @525V (kVAR)	Isi Paket terdiri dari			Referensi Paket	Harga (Rp) <i>(Sebelum PPN)</i>	SS
		Item	Qty	Referensi			
Untuk Tegangan Jaringan 400V, 50Hz Tegangan Kapasitor 525V / 7% Detuned Reactor							
12.5	20	Capacitor	1	BLRCH200A240B52	CAPCDR125	15.609.000	1
		Detuned Reactor	1	LVR07125A40T			
25	40	Capacitor	1	BLRCH400A480B52	CAPCDR250	19.355.000	2
		Detuned Reactor	1	LVR07250A40T			
50	80	Capacitor	2	BLRCH400A480B52	CAPCDR500	27.460.000	2
		Detuned Reactor	1	LVR07500A40T			
100	160	Capacitor	4	BLRCH400A480B52	CAPCDRX00	47.253.000	1
		Detuned Reactor	1	LVR07X00A40T			



Scan untuk Data Teknis

Detuned Reactor

Detuned Reactor EasyLogic PFC & Asosiasi dengan Kapasitor EasyLogic PFC

Schneider meluncurkan paket asosiasi Kapasitor EasyLogic PFC + Detuned Reactor EasyLogic PFC untuk memenuhi kebutuhan dalam kondisi polusi harmonik cukup tinggi (Gh/Sn < 25%)

- **MAX**imize optimasi OPEX dengan mengurangi rugi-rugi daya hingga 30% lebih rendah.

Watt-loss @ Rated Current	25 kvar, 7%	50 kvar, 7%
Detuned Reactor EasyLogic PFC	80W (36.1 Amp)	110W (78.2 Amps)

- **MAX**imize efisiensi suhu kerja hingga 20% lebih rendah.
- **MAX**imize efisiensi operasional.

Tuning %	Current Harmonic Spectrum				
	I3	I5	I7	I11	I13
7%	4%	37%	13%	5%	3%



■ Tabel Asosiasi Detuned Reactor + Kapasitor PowerLogic PFC Standard Duty

Daya Reaktif (kVAR)			Kode Dimensi	Referensi	Harga (Rp) (Sebelum PPN)	SS
415 V	480 V	525 V				
PowerLogic PFC Standard Duty, Tegangan kapasitor : 525 V						
12.5	16.7	20	SC	BLRCS200A240B52	3.031.000	2

■ Kombinasi EasyLogic PFC

Effective Power @400V (kVAR)	QN @ 525V (kVAR)	Kapasitor		7% fr=190Hz	Switching: Contactor Ref.	Breaker EasyPact CVS (Icu: 36kA)
		Refrensi	Tipe			
Untuk Tegangan Jaringan 400V, 50Hz Tegangan Kapasitor 525V / 7% Filter						
12.5	20	BLRCS200A240B52 x 1	Can	LVR07125A40LO x 1	LC1D18	LV510331
25	40	BLRCS200A240B52 x 2	Can	LVR07250A40LO x 1	LC1D38	LV510334
50	80	BLRCS200A240B52 x 4	Can	LVR07500A40LO x 1	LC1D95	LV510337
100	160	BLRCS200A240B52 x 8	Can	LVR07X00A40LO x 1	LC1G185	LV525332

■ Paket Kombinasi Kapasitor EasyLogic PFC dan Detuned Reactor EasyLogic PFC

Effective Power @400V (kVAR)	QN @525V (kVAR)	Isi Paket terdiri dari			Referensi Paket	Harga (Rp) (Sebelum PPN)	SS
		Item	Qty	Referensi			
Untuk Tegangan Jaringan 400V, 50Hz Tegangan Kapasitor 525V / 7% Detuned Reactor							
12.5	20	Capacitor	1	BLRCS200A240B52	EASYMAX125	8.594.000	2
		Detuned Reactor	1	LVR07125A40LO			
25	40	Capacitor	2	BLRCS200A240B52	EASYMAX250	13.507.000	2
		Detuned Reactor	1	LVR07250A40LO			
50	80	Capacitor	4	BLRCS200A240B52	EASYMAX500	20.375.000	2
		Detuned Reactor	1	LVR07500A40LO			
100	160	Capacitor	8	BLRCS200A240B52	EASYMAXX00	37.970.000	2
		Detuned Reactor	1	LVR07X00A40LO			





Scan untuk Data Teknis



EasyLogic PFC Controller



Scan untuk Data Teknis



PowerLogic PFC Controller

Regulator dan Kelengkapan Keunggulan

■ Aplikasi

Pada kompensasi otomatis, regulator digunakan untuk pengaturan stepnya. Dengan teknologi digital, tersedia 2 jenis regulator, yaitu: **PowerLogic PFC Controller dan EasyLogic PFC Controller**

Spesifikasi Umum

Output Relay	
AC	5A / 120V, 2A / 250V, 1A / 400V
DC	0.3A / 110V, 0.6A / 60V, 2A / 24V
Protection Index	
Depan Panel	IP41
Belakang	IP20
Arus Pengukura	0 - 5 Ampere

■ Perbedaan mendasar tipe EasyLogic PFC Controller & PowerLogic PFC Controller

Fitur	EasyLogic PFC Controller	PowerLogic PFC Controller
Jumlah Step	6,8 dan 12 step	6 dan 12 step
Tegangan Supply (VAC) 50/60 Hz	<ul style="list-style-type: none"> 185 hingga 265 VAC 320 hingga 460 VAC 	<ul style="list-style-type: none"> 90 hingga 550 VAC
Komunikasi Modbus	Tidak	Ada
Display	4 digit LED 7-Segment	Grafik LCD 56x2
Dimensi (mm)	143 x 143 x 67	144 x 144 x 58
Flush Panel Mounting	Ya	Ya
35 mm DIN rail Mounting	Tidak	Tidak
Alarm History	Tidak	5 alarm terakhir
Internal Temp Probe	Tidak	Ya. Offset temperatur dapat diprogram
Alarm Relay	<ul style="list-style-type: none"> Over voltage Over compensation Target Cos Phi tidak tercapai 	<ul style="list-style-type: none"> Kelebihan suhu - arus - tegangan, PF rendah, step derating, limit alarm THD(u), distorsi tegangan Batas operasional maksimal Jumlah dan waktu switching
Temperatur Operasi	0-55 °C	0-60 °C
Tipe Koneksi	Fasa-Fasa	Fasa-Fasa & Fasa-Netral
Target cosϕ setting	0.85 induktif hingga 1	0.7 induktif hingga 0.7 kapasitif
Response delay time	10 hingga 1800 detik	1 hingga 6500 detik
Step setting	Predefined & Adjustable step	Predefined & Adjustable step
CT compatible	hingga 10,000/5 A	hingga 9600 A (arus primer)
Fitur lain		<ul style="list-style-type: none"> Kontrol cos phi ganda melalui input digital atau deteksi daya ekspor. Algoritma kontrol baru yang dirancang untuk mengurangi jumlah operasi switching dan dengan cepat meraih daya yang ditargetkan. Deteksi dan tampilan daya, jumlah switching & derating dari semua step yang terkoneksi. Inisialisasi otomatis dan deteksi bank secara otomatis. Koreksi mandiri dengan mematikan (switch off) step saat muncul alarm THDu, alarm temperatur dan alarm limit overload.

■ Regulator Kapasitor Schneider

Jenis regulator	Referensi	Harga (Rp) (Sebelum PPN)	SS
PowerLogic PFC Controller - PF regulator 6 step	VPL06N	12.274.000	1
PowerLogic PFC Controller - PF regulator 12 step	VPL12N	14.082.000	1
EasyLogic PFC Controller - PF regulator 6 Step	51207	5.063.000	1
EasyLogic PFC Controller - PF regulator 8 Step	51209	6.674.000	1
EasyLogic PFC Controller - PF regulator 12 step	51213	8.374.000	1



Scan untuk Data Teknis



LC1DWM12M7

Skema Koneksi Kontaktor Khusus

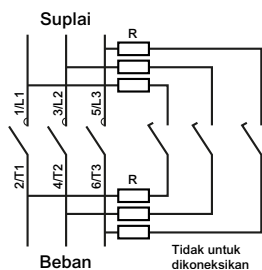

Kontaktur Kapasitor Penggunaan

Penggunaan Kontaktur Kapasitor

Kontaktur diperlukan sebagai peralatan kontrol. Dalam pemilihannya harus melihat arus puncak yang terjadi pada saat penyambungan. Arus puncak (I_{peak}) ini bisa mencapai 200 kali arus nominal kapasitor. Dengan penambahan koil, arus puncak tersebut bisa dibatasi mencapai 100 In.

Dengan kontaktur Schneider, yang merupakan kontaktur khusus dengan kutub tersambung lebih dulu, fenomena arus puncak tersebut dapat diatasi sehingga tidak lagi memerlukan lilitan (koil). Sehingga keandalannya dapat semakin meningkat. Contohnya : kontaktur **LC1DWM12** yang tadinya hanya untuk daya sampai 50 kvar (pada 400 V), kini mampu bekerja pada daya **60 kvar**.

Kontaktur LC1D●K dari Schneider memiliki daya tahan untuk 300.000 kali operasi

PENTING
Untuk instalasi kapasitor bank dengan detuned reactor dapat menggunakan kontaktur standar sesuai rekomendasi tabel di halaman 10-10 dan 10-11 karena Detuned Reactor sudah berfungsi sebagai pembatas arus lonjakan.

Tabel Penggunaan kontaktur khusus

Daya Reaktif (kVAR) temperatur rata-rata ≤50°C			Kontak		Referensi	Harga (Rp) (Sebelum PPN)	SS
220/240 V	400/440 V	660/690 V	N/O	N/C			
6,7	12,5	18	1	2	LC1DFKM7	1.743.000	1
8,5	16,7	24	1	2	LC1DGKM7	1.949.000	1
10	20	30	1	2	LC1DLKM7	2.518.000	2
15	25	36	1	2	LC1DMKM7	2.601.000	1
20	33,3	48	1	2	LC1DPKM7	4.290.000	2
25	40	58	1	2	LC1DTKM7	4.649.000	1
40	60	92	1	2	LC1DWM12M7	4.868.000	1

Catatan :

- **Koil M7 = 220 VAC.** Untuk tipe tegangan koil lainnya silakan hubungi Customer Care Center kami
- Kontaktur special di atas dapat menerima arus puncak sampai 200 In saat terjadi penyambungan
- Untuk pemasangan dengan kontaktur standard bisa memperhatikan tabel berikut :
(dengan catatan perlu menggunakan koil induktor)

Daya Reaktif (kVAR) Suhu rata-rata ≤55°C			Arus puncak maksimum (A)	Ukuran Kontaktur
220/240 V	400/440 V	600/690 V		
6	11	15	560	LC1D09, D12
9	15	20	850	LC1D18
11	20	25	1600	LC1D25
14	25	30	1900	LC1D32, D38
17	30	37	2160	LC1D40
22	40	50	2160	LC1D50
22	40	50	3040	LC1D65
35	60	75	3040	LC1D80, D95
38	75	80	3100	LC1D115
40	85	90	3300	LC1D150
50	100	100	3500	LC1G185
60	110	110	4000	LC1G225
75	125	125	5000	LC1G265
85	140	165	6500	LC1G330
100	160	200	8000	LC1G400

- Untuk ketersediaan koil, silakan cek di bagian kontaktur TeSys



Pemutus Tenaga Penggunaan

Penggunaan Pemutus Tenaga

Penggunaan Pemutus tenaga pada sistem koreksi faktor daya otomatis digunakan untuk menghindari bilamana terjadi hubung singkat, beban lebih dan kontak tanah (*earth fault*) Kapasitas pemutusan dari alat ini harus sama dengan arus hubung singkat maksimum yang mungkin terjadi pada sekitar pangkal tumpuk kapasitor.

Untuk menghitung besarnya arus tersebut, dapat digunakan rumus sebagai berikut :

$$I_{nc} = \frac{Q_c}{U\sqrt{3}}$$

I_{nc} = arus nominal kapasitor (dalam ampere)
 Q_c = daya kapasitor (dalam var)
 U = tegangan jaringan 3-fase (dalam Volt)

Pemilihan pemutus tenaga dan Setting termal (I_{nb}) harus sesuai berikut :

- 1.5 I_n untuk aplikasi kapasitor saja tanpa Detuned Reactor
- 1.19 I_n untuk aplikasi kapasitor dengan Detuned Reactor 7%
- Proteksi hubung singkat sebesar 10 x I_{nb}

Contoh

■ Kapasitor tanpa penggunaan Detuned Reactor

150kvar/400v – 50Hz Capacitor ► $U_s = 400V$; $Q_s = 150$ kVar
 Kapasitor yg digunakan ► $U_n = 400V$; $Q_n = 150$ kVar
 $I_{nc} = 150000/(400\sqrt{3}) = 216$ A
 Rating pemutus tenaga = 216 A x 1.5 = 324 A

Pilih pemutus tenaga (breaker) dengan rating di atas 324 A, contoh **400 A**

Dengan setting termal = $216 \times 1.5 = 324A$, dan setting magnetis (hub. singkat) = $324 \times 10 = 3240$ A

■ Kapasitor dengan penggunaan Detuned Reactor

125kvar/400v – 50Hz dengan Detuned Reactor (7%) ► $U_s : 400V$; $Q_s = 25$ kVar
 Kapasitor yang digunakan ► $U_n = 525V$; $Q_n = 40.1$ kVar (*Lihat Detuned Reactor Asosiasi dengan Kapasitor*)
 $I_{nc} = 40100/(525\sqrt{3}) = 44.1$ A
 Rating pemutus tenaga = 44.1 A x 1.5 = 66.15 A

Pilih pemutus tenaga (breaker) dengan rating di atas 66.15 A, contoh **75 A**

Pemutus tenaga dengan setting termal = $44.1 \times 1.19 = 52.48$ A,

Setting magnetis (hub. Singkat) = **524.8 A**

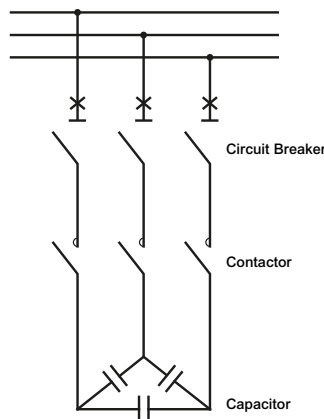

U_s = Tegangan jaringan
 Q_s = kVar yang diperlukan di jaringan pada tegangan U_n
 U_n = Tegangan kapasitor
 Q_n = nilai kVar kapasitor pada tegangan U_n



Life Is On

Schneider
Electric

Industrial Plug & Socket

Mobile Plug	11-3
IP44	11-3
IP67	11-3
Mobile Socket	11-4
IP44	11-4
IP67	11-4
Wall Mounted Socket	11-5
IP44	11-5
IP67	11-5
Panel Mounted Angled Socket	11-6
IP44	11-6
IP67	11-6
S56 Sakelar	11-7
S56 Sakelar	11-7
S56 Kotak Kontak	11-8
S56 Kotak Kontak	11-8
S56 Kotak Kontak dengan Sakelar	11-8
S56 Kotak Kontak RCD dan Tusuk Kontak	11-9
S56 Kotak Kontak RCD	11-9
S56 Tusuk Kontak	11-9

Mobile Plug

Karakteristik

- Tingkat proteksi mengacu pada IEC 60529.
 - 16 dan 32 A, IP 44 dan IP 67.
 - 63 dan 125 A, IP 67.
- Tingkat ketahanan terhadap benturan mekanis dari luar mengacu pada EN 50 102 IK08.
- Ketahanan terhadap api dan panas yang tidak normal, mengacu pada IEC 60695-2-1 : 850°C (uji kawat bakar/glow wire test).
- Bahan mobile plug terdiri dari :
 - Housing terbuat dari polimer yang dapat padam sendiri jika terbakar.
 - Pin yang terbuat dari kuningan.
 - Baut dari baja anti karat.
- Terminal koneksi
 - Baut pengencang.
 - Maksimum luas penampang dari konduktor sebagai berikut :

Arus Pengenal	16 A	32 A	63 A	125 A
Luas Penampang (mm ²)	1 s/d 4	2.5 s/d 10	6 s/d 25	16 s/d 70



Mobile Plug
IP 44

■ IP 44

Arus Pengenal	Jumlah Kutub	Tegangan Pengenal	Warna	Referensi	Harga (Rp) (Sebelum PPN)	SS
16 A	2P + Pe	200 - 250V	Biru	PKE16M423	137.660	1
	3P + Pe	380 - 415V	Merah	PKE16M434	151.940	2
	3P + N + Pe	380 - 415V	Merah	PKE16M435	186.900	2
32 A	2P + Pe	200 - 250V	Biru	PKE32M423	203.280	1
	3P + Pe	380 - 415V	Merah	PKE32M434	213.890	1
	3P + N + Pe	380 - 415V	Merah	PKE32M435	245.810	1



Mobile Plug
IP 67

■ IP 67

Arus Pengenal	Jumlah Kutub	Tegangan Pengenal	Warna	Referensi	Harga (Rp) (Sebelum PPN)	SS
16 A	2P + Pe	200 - 250V	Biru	PKE16M723	274.790	2
	3P + Pe	380 - 415V	Merah	PKE16M734	298.310	2
	3P + N + Pe	380 - 415V	Merah	PKE16M735	305.870	2
32 A	2P + Pe	200 - 250V	Biru	PKE32M723	366.240	2
	3P + Pe	380 - 415V	Merah	PKE32M734	400.890	2
	3P + N + Pe	380 - 415V	Merah	PKE32M735	430.500	1
63 A	3P + Pe	380 - 415V	Merah	81382	753.100	2
	3P + N + Pe	380 - 415V	Merah	81383	849.000	2
125 A	3P + Pe	380 - 415V	Merah	81394	2.856.000	2
	3P + N + Pe	380 - 415V	Merah	81395	3.436.700	2

Mobile Socket

Karakteristik

- Tingkat proteksi mengacu pada IEC 60529.
 - 16 dan 32 A, IP 44 dan IP 67.
 - 63 dan 125 A, IP 67.
- Tingkat ketahanan terhadap benturan mekanis dari luar mengacu pada EN 50 102 IK08.
- Ketahanan terhadap api dan panas yang tidak normal, mengacu pada IEC 60695-2-1 : 850°C (uji kawat bakar/glow wire test).
- Bahan mobile socket terdiri dari :
 - Housing terbuat dari polimer yang dapat padam sendiri jika terbakar.
 - Pin yang terbuat dari kuningan.
 - Baut dari baja anti karat.
- Terminal koneksi
 - Baut pengencang.
 - Maksimum luas penampang dari konduktor sebagai berikut :

Arus Pengenal	16 A	32 A	63 A	125 A
Luas Penampang (mm ²)	1 s/d 4	2.5 s/d 10	6 s/d 25	16 s/d 70

■ IP 44



Wander Socket
IP 44

Arus Pengenal	Jumlah Kutub	Tegangan Pengenal	Warna	Referensi	Harga (Rp) (Sebelum PPN)	SS
16 A	2P + Pe	200 - 250V	Biru	PKF16M423	201.500	1
	3P + Pe	380 - 415V	Merah	PKF16M434	218.510	2
	3P + N + Pe	380 - 415V	Merah	PKF16M435	248.220	2
32 A	2P + Pe	200 - 250V	Biru	PKF32M423	270.270	2
	3P + Pe	380 - 415V	Merah	PKF32M434	272.480	2
	3P + N + Pe	380 - 415V	Merah	PKF32M435	326.870	2

■ IP 67



Wander Socket
IP 67

Arus Pengenal	Jumlah Kutub	Tegangan Pengenal	Warna	Referensi	Harga (Rp) (Sebelum PPN)	SS
16 A	2P + Pe	200 - 250V	Biru	PKF16M723	335.200	2
	3P + Pe	380 - 415V	Merah	PKF16M734	383.200	2
	3P + N + Pe	380 - 415V	Merah	PKF16M735	428.400	2
32 A	2P + Pe	200 - 250V	Biru	PKF32M723	482.200	2
	3P + Pe	380 - 415V	Merah	PKF32M734	502.900	2
	3P + N + Pe	380 - 415V	Merah	PKF32M735	555.500	2
63 A	2P + Pe	200 - 250V	Biru	81478	887.900	2
	3P + Pe	380 - 415V	Merah	81482	980.200	2
	3P + N + Pe	380 - 415V	Merah	81483	1.199.100	2
125 A	2P + Pe	200 - 250V	Biru	81490	2.961.700	2
	3P + N + Pe	380 - 415V	Merah	81495	3.989.000	2

Wall Mounted Socket

Karakteristik

- Tingkat proteksi mengacu pada IEC 60529.
 - 16 dan 32 A, IP 44 dan IP 67.
 - 63 dan 125 A, IP 67.
- Tingkat ketahanan terhadap benturan mekanis dari luar mengacu pada EN 50 102 IK08.
- Ketahanan terhadap api dan panas yang tidak normal, mengacu pada IEC 60695-2-1 : 850°C (uji kawat bakar/glow wire test).
- Bahan wall mounted socket terdiri dari :
 - Housing terbuat dari polimer yang dapat padam sendiri jika terbakar.
 - Pin yang terbuat dari kuningan.
 - Baut dari baja anti karat.
- Terminal koneksi
 - Baut pengencang.
 - Maksimum luas penampang dari konduktor sebagai berikut :

Arus Pengenal	16 A	32 A	63 A	125 A
Luas Penampang (mm ²)	1 s/d 4	2.5 s/d 10	6 s/d 25	16 s/d 70

■ IP 44



Wall Mounted Socket
Socket IP 44

Arus Pengenal	Jumlah Kutub	Tegangan Pengenal	Warna	Referensi	Harga (Rp) (Sebelum PPN)	SS
16 A	2P + Pe	200 - 250V	Biru	83104	235.830	2
	3P + Pe	380 - 415V	Merah	83108	312.010	2
	3P + N + Pe	380 - 415V	Merah	83109	429.720	2
32 A	2P + Pe	200 - 250V	Biru	83116	374.640	2
	3P + Pe	380 - 415V	Merah	83120	456.860	1
	3P + N + Pe	380 - 415V	Merah	83121	456.810	1

■ IP 67



Wall Mounted Socket
Socket IP 67

Arus Pengenal	Jumlah Kutub	Tegangan Pengenal	Warna	Referensi	Harga (Rp) (Sebelum PPN)	SS
16 A	2P + Pe	200 - 250V	Biru	83154	390.500	2
	3P + Pe	380 - 415V	Merah	83158	482.900	2
	3P + N + Pe	380 - 415V	Merah	83159	491.800	2
32 A	2P + Pe	200 - 250V	Biru	83166	536.600	2
	3P + Pe	380 - 415V	Merah	83170	538.200	2
	3P + N + Pe	380 - 415V	Merah	83171	587.000	2
63 A	2P + Pe	200 - 250V	Biru	81178	1.188.500	2
	3P + Pe	380 - 415V	Merah	81182	1.264.200	2
	3P + N + Pe	380 - 415V	Merah	81183	1.264.200	2
125 A	3P + Pe	380 - 415V	Merah	81194	5.347.700	2
	3P + N + Pe	380 - 415V	Merah	81195	5.085.000	2

Panel Mounted Angled Socket

Karakteristik

- Dapat dipasang pada pintu panel.
- Tingkat proteksi mengacu pada IEC 60529.
 - 16 dan 32 A, IP 44 dan IP 67.
 - 63 dan 125 A, IP 67.
- Tingkat ketahanan terhadap benturan mekanis dari luar mengacu pada EN 50 102 IK08.
- Ketahanan terhadap api dan panas yang tidak normal, mengacu pada IEC 60695-2-1 : 850°C (uji kawat bakar/glow wire test).
- Bahan panel mounted angled socket terdiri dari :
 - Housing terbuat dari polimer yang dapat padam sendiri jika terbakar.
 - Pin yang terbuat dari kuningan.
 - Baut dari baja anti karat.
- Terminal koneksi
 - Baut pengencang.
 - Maksimum luas penampang dari konduktor sebagai berikut :

Arus Pengenal	16 A	32 A	63 A	125 A
Luas Penampang (mm ²)	1 s/d 4	2.5 s/d 10	6 s/d 25	16 s/d 70



Panel Mounted Angled Socket IP 44

■ IP 44

Arus Pengenal	Jumlah Kutub	Tegangan Pengenal	Warna	Referensi	Harga (Rp) (Sebelum PPN)	SS
16 A	2P + Pe	200 - 250V	Biru	PKF16F423	159.000	1
	3P + Pe	380 - 415V	Merah	PKF16F434	203.300	2
	3P + N + Pe	380 - 415V	Merah	PKF16F435	226.800	2
32 A	2P + Pe	200 - 250V	Biru	PKF32F423	260.300	2
	3P + Pe	380 - 415V	Merah	PKF32F434	291.300	2
	3P + N + Pe	380 - 415V	Merah	PKF32F435	291.300	1



Panel Mounted Angled Socket IP 67

■ IP 67

Arus Pengenal	Jumlah Kutub	Tegangan Pengenal	Warna	Referensi	Harga (Rp) (Sebelum PPN)	SS
16 A	2P + Pe	200 - 250V	Biru	PKF16F723	252.320	2
	3P + Pe	380 - 415V	Merah	PKF16F734	288.330	2
	3P + N + Pe	380 - 415V	Merah	PKF16F735	315.210	2
32 A	2P + Pe	200 - 250V	Biru	PKF32F723	372.330	1
	3P + Pe	380 - 415V	Merah	PKF32F734	394.070	2
	3P + N + Pe	380 - 415V	Merah	PKF32F735	430.500	1
63 A	3P + N + Pe	380 - 415V	Merah	81283	1.088.900	2
125 A	2P + Pe	200 - 250V	Biru	81290	2.147.300	2
	3P + N + Pe	380 - 415V	Merah	81295	2.536.800	2



Industrial Plug & Socket

S56 Sakelar

S56 Sakelar

S56 series digunakan untuk beragam aplikasi seperti pabrik, pertanian, gedung komersial, kelautan, maupun untuk kebutuhan residensial di luar ruangan

Karakteristik

- IP66
- Tersedia Padlock untuk pengaman
- Sakelar Putar, 1 sampai 3 sakelar
- Pengenal arus 10A sampai 32A

■ IP 66

Arus Pengenal	Jumlah Sakelar	Tegangan Pengenal	Referensi	Harga (Rp) <i>(Sebelum PPN)</i>	SS
10	1	250	S56SW110GY	441.578	1
20	1	250	S56SW120GY	492.017	1
32	1	250	S56SW132GY	552.107	1
20	2	500	S56SW220GY	874.477	2
10	3	500	S56SW310GY	638.316	2
20	3	500	S56SW320GY	659.206	2
32	3	500	S56SW332GY	707.370	2



3 pin pipih



3 pin bulat



S56SO313GY



S56C313GY



S56C320GY



S56C550GY

Industrial Plug & Socket

S56 Kotak Kontak

S56 Kotak Kontak

S56 series digunakan untuk beragam aplikasi seperti pabrik, pertanian, gedung komersial, kelautan, maupun untuk kebutuhan residensial di luar ruangan.

Karakteristik

- IP66
- Tutup transparan
- Dilengkapi konektor pentanahan dan netral
- Tersedia pilihan 3-5 Pin, 10A-32A

■ S56 IP 66 Kotak Kontak

Arus Pengenal	Jumlah Pin	Dekskripsi	Tegangan Pengenal	Referensi	Harga (Rp) (Sebelum PPN)	SS
13	3	Pin pipih, Abu-abu	250	S56SO313GY	399.942	2
15	3	Pin pipih, Abu-abu	250	S56SO315GY	447.678	2
20	3	Pin bulat, Abu-abu	250	S56SO320GY	586.398	2
32	4	Pin bulat, Abu-abu	500	S56SO432GY	763.164	2
20	5	Pin bulat, Abu-abu	500	S56SO520GY	900.762	2
32	5	Pin bulat, Abu-abu	500	S56SO532GY	799.578	2

■ S56 IP 66 Kotak Kontak dan Sakelar

Arus Pengenal	Jumlah Pin	Dekskripsi	Tegangan Pengenal	Referensi	Harga (Rp) (Sebelum PPN)	SS
13	3	Pin kotak, Abu-abu	250	S56C313GY	712.266	1
20	3	Pin bulat, Abu-abu	250	S56C320GY	1.012.452	2
32	3	Pin bulat, Abu-abu	250	S56C332GY	1.035.708	2
20	4	Pin bulat, Abu-abu	500	S56C420GY	1.291.626	2
32	4	Pin bulat, Abu-abu	500	S56C432GY	1.388.016	1
32	5	Pin bulat, Abu-abu	500	S56C532GY	1.384.854	2
40	5	Pin bulat, Abu-abu	500	S56C540GY	1.730.736	2
50	5	Pin bulat, Abu-abu	500	S56C550GY	1.818.558	2



Industrial Plug & Socket

S56 Kotak Kontak RCD & Tusuk Kontak

S56 Kotak Kontak RCD

S56 series digunakan untuk beragam aplikasi seperti pabrik, pertanian, gedung komersial, kelautan, dan sebagainya. S56 juga berguna untuk lokasi outdoor dimana sakelar dan kotak kontak biasa tidak memadai seperti kolam renang dan lapangan tenis.

Karakteristik

- IP66
- Tutup transparan
- Daya listrik terputus dengan cepat dalam keadaan darurat.

■ IP 66

Arus Pengenal	Jumlah Pin	Dekskripsi	Tegangan Pengenal	Referensi	Harga (Rp) (Sebelum PPN)	SS
13	3	Pin datar, Pelindung RCD, Grey	250	S56C313RCD30GY	2.075.811	2

S56 Tusuk Kontak

S56 series digunakan untuk beragam aplikasi seperti pabrik, pertanian, gedung komersial, kelautan, dan sebagainya. S56 juga berguna untuk lokasi luar ruang (outdoor), di mana sakelar dan kotak kontak biasa tidak memadai, contohnya di kolam renang dan di lapangan tenis.

Karakteristik

- IP66
- Plug bersiku untuk instalasi yang rapih
- Ring bersekrup untuk keamanan kotak kontak
- Tersedia pilihan 3-5 Pin, 10A-50A

■ IP 66

Arus Pengenal	Jumlah Pin	Dekskripsi	Tegangan Pengenal	Referensi	Harga (Rp) (Sebelum PPN)	SS
13	3	Pin datar, Grey	250	S56P313GY_G15	522.138	2
15	3	Pin datar, Grey	250	S56P315GY_G15	761.532	2
20	3	Pin bulat, bersiku, Orange	250	S56PA320EO_G15	603.534	2
32	4	Pin bulat, bersiku, Orange	500	S56PA432EO_G15	865.368	2
20	5	Pin bulat, bersiku, Orange	500	S56PA520EO_G15	1.010.208	2
32	5	Pin bulat, bersiku, Orange	500	S56PA532EO_G15	1.084.974	1
50	5	Pin bulat, bersiku, Orange	500	S56PA550EO_G15	1.190.952	2





Meter & Manajemen Energi

PowerTag	12-3
PowerTag Acti9 & PowerTag NSX	12-3
PowerTag Flex 160A & PowerTag Rope	12-4
Tabel Seleksi PowerTag 63 A	12-5
Tabel Seleksi PowerTag Flex 160 A	12-7
Tabel Seleksi PowerTag NSX	12-8
Tabel Seleksi PowerTag Rope	12-9
Current Transformer Solid Core	12-10
Dimensi CT	12-11
Current Transformer Split Core	12-12
Dimensi CT	12-13
Kilowatt Hour Meter	12-14
KWh Meter 1-fasa	12-14
KWh Meter 3-fasa	12-14
Digital Meter	12-15
Ampere Meter, Volt Meter, dan Frekuensi Meter Digital	12-15
Digital Meter dan Power Meter	12-16
Digital Meter Seri DM6200H dan Power Meter Seri PM2000	12-16
Power Meter	12-17
Power Meter Seri PM5000 & PM8000	12-17
Power Meter Seri ION9000	12-18
Ethernet Gateway & Energy Server	12-19
EcoStruxure Panel Server	12-19



Scan untuk
Data Teknis

PowerTag PowerTag Acti9 & PowerTag NSX

PowerTag

PowerTag adalah sensor energi tanpa kabel (*wireless*) untuk MCB & MCCB yang berfungsi:



Membaca informasi penggunaan energi / kwh (Class 1)



Membaca informasi Arus, Tegangan, Daya, Faktor Daya secara real time.



Menampilkan Load Balance (via halaman web/webpage concentrator).



Memberikan Alarm apabila terjadi Voltage Loss atau hasil pengukuran melewati batas yang sudah ditentukan.

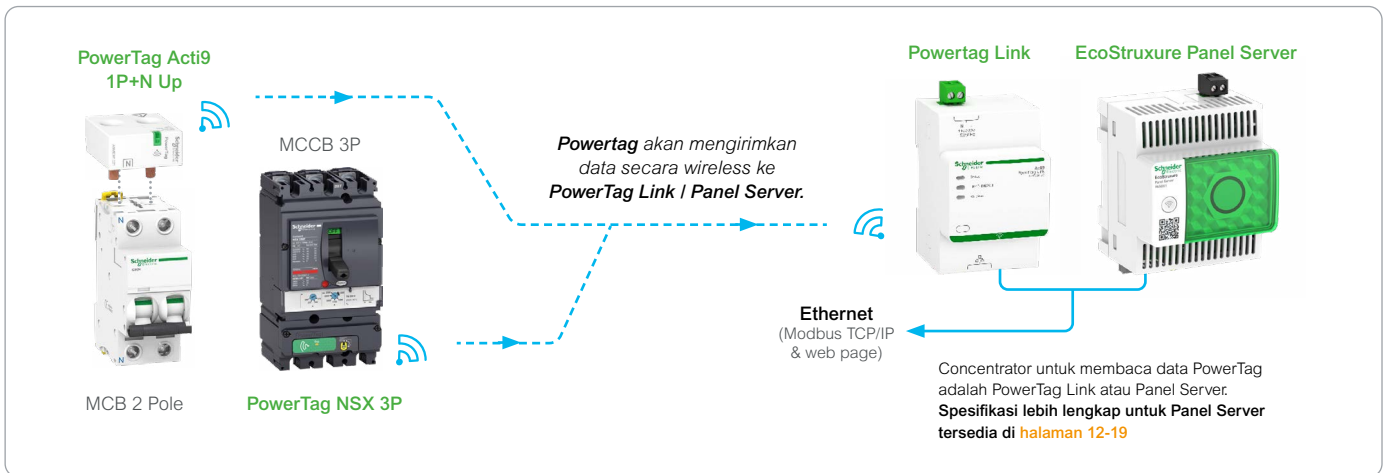

A9MEM1520



A9MEM1522



A9MEM1540



A9MEM1542



LV434020



LV434023



Data hasil pembacaan dari PowerTag Link / Panel Server juga dapat dibaca oleh software BMS (Building Management System) yang menggunakan protokol Modbus TCP/IP.

Referensi	Deskripsi	Harga (Rp) (Sebelum PPN)	SS
PowerTag Acti9			
A9MEM1520	PowerTag Acti9 1P up/down	1.691.000	2
A9MEM1522	PowerTag Acti9 1P + N down	1.691.000	2
A9MEM1540	PowerTag Acti9 3P up/down	3.731.000	2
A9MEM1542	PowerTag Acti9 3P+N down	3.731.000	2
A9MEM1560	PowerTag Acti9 Flex 1P+N up/down	1.691.000	2
A9MEM1570	PowerTag Acti9 Flex 3P+N up/down	3.731.000	2
A9MEM1573	PowerTag Acti9 Flex 3P	4.039.000	2
PowerTag NSX			
LV434020	PowerTag NSX 250 3P	6.108.000	2
LV434021	PowerTag NSX 250 3P+N	6.913.000	2
LV434022	PowerTag NSX 630 3P	11.877.000	2
LV434023	PowerTag NSX 630 3P+N	13.064.000	2
PowerTag Link & Panel Server			
A9XMWD20	PowerTag Link (hingga 20 PowerTag), 220VAC	3.699.000	2
PAS600L	Panel Server Universal (hingga 100 PowerTag), 24VDC	10.132.000	1
PAS800L	Panel Server Advanced (hingga 100 PowerTag), 24VDC	15.308.000	1

Catatan :

- "Down" artinya PowerTag yang khusus ditempatkan di bagian bawah MCB.
- "Up/Down" artinya PowerTag dapat ditempatkan di atas maupun di bawah MCB.



Scan untuk
Data Teknis

PowerTag

PowerTag Flex 160 & PowerTag Rope

Range produk PowerTag semakin lengkap dengan kehadiran PowerTag Flex 160 dan PowerTag Rope.



PowerTagFlex 160 A

■ PowerTag Flex 160

PowerTag Flex 160 memiliki desain fleksibel dan dapat digunakan pada banyak jenis beban hingga 160 A pada jaringan 3P atau 3P+N. Spring connector yang dapat dilepas untuk kebutuhan pengukuran tegangan dan bentuknya yang praktis dipasang dengan bracket memungkinkan untuk diletakkan secara fleksibel di dalam panel.



PowerTagRope

■ PowerTag Rope

PowerTag Rope memiliki sensor arus yang fleksibel dan dapat dibuka sehingga dapat dipasang dengan mudah pada busbar dan kabel tanpa harus melepaskan konduktor. Cocok untuk jenis beban besar hingga 2000 A pada jaringan 3P atau 3P + N.

Spring connector yang dapat dilepas untuk kebutuhan pengukuran tegangan dan modul yang dapat dipasang pada DIN rail atau bracket memungkinkan untuk diletakkan secara fleksibel di dalam panel.

Referensi	Deskripsi	Harga (Rp) <i>(Sebelum PPN)</i>	SS
A9MEM1580	PowerTag Flex 160 A 3P / 3P+N	4.158.000	2
A9MEM1590	PowerTag Rope 200 A 3P / 3P+N	9.562.000	2
A9MEM1591	PowerTag Rope 600 A 3P / 3P+N	10.838.000	2
A9MEM1592	PowerTag Rope 1000 A 3P / 3P+N	12.111.000	2
A9MEM1593	PowerTag Rope 2000 A 3P / 3P+N	12.749.000	2



Contoh Pemasangan PowerTag Flex 160 A



Contoh Pemasangan PowerTag Flex Rope pada Busbar



Scan untuk
Data Teknis

PowerTag

Tabel Seleksi PowerTag 63A

PowerTag Energy 63A			
Products (AC Network)	Mounting Position	A9 M63	A9 F63
Acti9/Multi9			
Circuit breakers equipped with Vigi module (cont)			
C120 ≤ 63 A	Top	-	☑ ⁽¹⁾ (CB)
NG125 ≤ 63 A with Vigi Module	Bottom	-	☑ ⁽¹⁾ (Vigi)
Residual current devices			
iID/iID K	Top	☑	-
	Bottom	☑	-
iID (double terminal)	Top	-	☑
	Bottom	-	☑
iID40	Top	-	☑ ⁽²⁾ (3P+N)
	Bottom	☑	-
iDPN Vigi "outgoer" 1P+N	Top	-	-
	Bottom	-	-
iC60H RCBO/iC60H2 RCBO/iKQE RCBO	Top	NA (fishbone)	-
	Bottom	-	-
iC60 RCBO	Top	☑	-
	Bottom	☑	-
iCV40 "outgoer" 1P+N	Top	-	-
	Bottom	-	-
iCV40 "outgoer" 3P+N	Top	-	-
	Bottom	-	☑
DPN Vigi/DT40 Vigi/C40 Vigi "outgoer" 1P+N	Top	-	-
	Bottom	-	-
DPN Vigi/DT40 Vigi/C40 Vigi/ iDPN Vigi "outgoer" 3P+N	Top	-	-
	Bottom	-	☑
DPN Vigi K	Top	-	☑ ⁽¹⁾
	Bottom	-	☑ ⁽¹⁾
N40 Vigi "outgoer"	Top	-	-
	Bottom	-	-
iDc/ITG40/C40	Top Left	-	-
	Top Right	-	-
DCP Vigi	Top	☑	-
	Bottom	☑	-
C60H RCBO (Multi9)	Top	Na (fishbone)	-
	Bottom	-	-
ID ≤ 63 A/iD K biconnect ID Type B ≤ 63 A	Top	☑	-
	Bottom	☑	-
RED/REDS/REDTest	Top	-	☑ ⁽¹⁾
	Bottom	-	☑ ⁽¹⁾

(1) You may need to change the voltage measurement cable terminals of the PowerTag Energy F63 by other cable ends (wire AWG22/0.33 mm²) for a more suitable connection to this product.
 (2) Product usually associated with a comb busbar



Scan untuk
Data Teknis

PowerTag

Tabel Seleksi PowerTag 63A

PowerTag Energy 63A			
Products (AC Network)	Mounting Position	A9 M63	A9 F63
Acti9/Multi9			
Switches			
iSW ≤ 63 A	Top	<input checked="" type="checkbox"/>	-
	Bottom	<input checked="" type="checkbox"/>	-
iSW-NA ≤ 63 A	Top	<input checked="" type="checkbox"/>	-
	Bottom	<input checked="" type="checkbox"/>	-
iSW 20/32 A	Top	-	<input checked="" type="checkbox"/>
	Bottom	-	<input checked="" type="checkbox"/>
i-NA ≤ 63 A	Top	<input checked="" type="checkbox"/>	-
	Bottom	<input checked="" type="checkbox"/>	-
NG125 NA ≤ 63 A	Top	-	<input checked="" type="checkbox"/> ⁽¹⁾
	Bottom	-	<input checked="" type="checkbox"/> ⁽¹⁾
Fuse disconnectors			
STI	Top	-	-
	Bottom	-	-
SBI 14x51/SBI 22x58 ≤ 63 A	Top	-	<input checked="" type="checkbox"/> ⁽¹⁾
	Bottom	-	<input checked="" type="checkbox"/> ⁽¹⁾
D01/D02	Top	-	<input checked="" type="checkbox"/> ⁽¹⁾
	Bottom	-	<input checked="" type="checkbox"/> ⁽¹⁾
TeSys			
Motor circuit breakers			
GV2	Top	-	<input checked="" type="checkbox"/> ^{(1) (2)}
	Bottom	-	<input checked="" type="checkbox"/> ^{(1) (2)}
GV3 ≤ 63 A	Top	-	<input checked="" type="checkbox"/> ^{(1) (2)}
	Bottom	-	<input checked="" type="checkbox"/> ^{(1) (2)}
Contactors			
TeSys D ≤ 63 A	Top	-	<input checked="" type="checkbox"/> Upstream only ⁽¹⁾
	Bottom	-	
TeSys K	Top	-	<input checked="" type="checkbox"/> Upstream only ⁽¹⁾
	Bottom	-	
Motor starter			
TeSys U	Top	-	<input checked="" type="checkbox"/> Upstream only ⁽¹⁾
	Bottom	-	

⁽¹⁾ You may need to change the voltage measurement cable terminals of the PowerTag Energy F63 by other cable ends (wire AWG22/0.33 mm²) for a more suitable connection to this product.

⁽²⁾ Powertag Energy sensors withstand motor starting in-rush currents. Environmental mission profile: Buildings as per 60721-3-3.



Scan untuk
Data Teknis

PowerTag

Tabel Seleksi PowerTag Flex 160A

PowerTag Energy 160 A			
Products (AC Network)		Mounting Position	 A9 M63
Acti9			
Circuit breakers			
C120 (with or without Vigî module)	3P / 3P+N	Top / Bottom	<input checked="" type="checkbox"/>
NG125 (with or without Vigî module)	3P / 3P+N	Top / Bottom	<input checked="" type="checkbox"/>
Residual current devices			
iID > 63 A	3P+N	Top / Bottom	<input checked="" type="checkbox"/>
RCCB-ID 125 A	3P+N	Top / Bottom	<input checked="" type="checkbox"/>
Fuse disconnectors			
SBI > 63 A	3P / 3P+N	Top / Bottom	<input checked="" type="checkbox"/>
Switches			
NG125 NA	3P / 3P+N	Top / Bottom	<input checked="" type="checkbox"/>
iSW > 63 A	3P / 3P+N	Top / Bottom	<input checked="" type="checkbox"/>
iSW NA > 63 A	3P+N	Top / Bottom	<input checked="" type="checkbox"/>
ComPact			
Circuit breakers			
NSXm	3P / 3P+N	Top / Bottom	<input checked="" type="checkbox"/> ⁽⁵⁾
Switches			
NSXm NA	3P / 3P+N	Top / Bottom	<input checked="" type="checkbox"/> ⁽⁵⁾
INS 80/100/125/160	3P / 3P+N	Top / Bottom	<input checked="" type="checkbox"/>
PowerPact			
Circuit breakers			
B	3P / 3P+N	Top / Bottom	<input checked="" type="checkbox"/> ⁽⁶⁾
TeSys			
Motor circuit breakers			
GV3 > 65 A	3P	Top / Bottom	<input checked="" type="checkbox"/>
GV4	3P	Top / Bottom	<input checked="" type="checkbox"/>
Motor circuit breakers			
63 A < TeSys D ≤ 160 A	3P / 3P+N	Top	<input checked="" type="checkbox"/> Upstream only
TeSys F ≤ 160 A	3P / 3P+N	Top	<input checked="" type="checkbox"/> Upstream only

⁽⁵⁾ It is advised to use EverLink connectors with control wire terminal (LV426970 for 3P / LV426971 for 4P)

⁽⁶⁾ It is advised to use EverLink connectors with control wire terminal (LV426974 for 3P / LV426975 for 4P)

			PowerTag Energy 250 A		PowerTag Energy 630 A	
						
Products (AC Network)	Mounting Position		M250 3P	M250 3P+N	M630 3P	M630 3P+N
■ ComPact						
Circuit breakers						
NSX100/160/250 B/F/N/H/S/L/R/NA Fixed	3P	Bottom	<input checked="" type="checkbox"/>	-	-	-
	4P	Bottom	-	<input checked="" type="checkbox"/>	-	-
NSX400/630 F/N/H/S/L/R/NA Fixed	3P	Bottom	-	-	<input checked="" type="checkbox"/>	-
	4P	Bottom	-	-	-	<input checked="" type="checkbox"/>
NSX100/160/250 B/F/N/H/S/L/R/NA Plug-In (mounted on the base)	3P	Top / Bottom	<input checked="" type="checkbox"/>	-	-	-
	4P	Top / Bottom	-	<input checked="" type="checkbox"/> (3)	-	-
NSX400/630 F/N/H/S/L/R/NA Plug-In (mounted on the base)	3P	Top / Bottom	-	-	<input checked="" type="checkbox"/> (4)	-
	4P	Top / Bottom	-	-	-	<input checked="" type="checkbox"/> (3) (4)
NS100/160/250 N/SX/H/NA Fixed	3P	Bottom	<input checked="" type="checkbox"/>	-	-	-
	4P	Bottom	-	<input checked="" type="checkbox"/>	-	-
NS400/630 N/H/L/NA Fixed	3P	Bottom	-	-	<input checked="" type="checkbox"/>	-
	4P	Bottom	-	-	-	<input checked="" type="checkbox"/>
N100/160/250 N/SX/H/L/NA Plug-In (mounted on the base)	3P	Top / Bottom	<input checked="" type="checkbox"/>	-	-	-
	4P	Top / Bottom	-	<input checked="" type="checkbox"/>	-	-
NS400/630 N/H/L/NA Plug-in (mounted on the base)	3P	Top / Bottom	-	-	<input checked="" type="checkbox"/> (4)	-
	4P	Top / Bottom	-	-	-	<input checked="" type="checkbox"/> (3) (4)
Circuit breakers equipped with Vigi block						
NSX100/160/250 B/F/N/H/S/L/R/NA Fixed	3P	Bottom	<input checked="" type="checkbox"/>	-	-	-
	4P	Bottom	-	<input checked="" type="checkbox"/>	-	-
NSX400/630 F/N/H/S/L/R/NA Fixed	3P	Bottom	-	-	<input checked="" type="checkbox"/>	-
	4P	Bottom	-	-	-	<input checked="" type="checkbox"/>
NSX100/160/250 B/F/N/H/S/L/R/NA Plug-In (mounted on the base)	3P	Top	<input checked="" type="checkbox"/>	-	-	-
NSX400/630 F/N/H/S/L/R/NA Plug-In (mounted on the base)	3P	Top	-	-	<input checked="" type="checkbox"/> (4)	-
Switches						
INS250/INV - 100/160/200/250	3P	Bottom	-	<input checked="" type="checkbox"/>	-	-
	4P	Top / Bottom	-	<input checked="" type="checkbox"/> (3)	-	-
INS/INV - 320/400/500/630	3P	Bottom	-	-	-	<input checked="" type="checkbox"/>
	4P	Top / Bottom	-	-	-	<input checked="" type="checkbox"/> (3)
■ TeSys						
motor circuit breakers						
GV5, GV7	3P	Bottom	<input checked="" type="checkbox"/>	-	-	-
GV6	4P	Bottom	-	-	<input checked="" type="checkbox"/>	-





(3) Neutral on the right when mounted on top side.

(4) When plate mounted, need to add a 4 mm intercalary under the PowerTag module (see ComPact NSX catalog).



Scan untuk
Data Teknis

DPLVP

PowerTag Energy Rope							
Products (AC Network)	Mounting Position						
ComPact							
Circuit breakers							
NS 630b	3P / 3P+N	Top / Bottom	-	<input checked="" type="checkbox"/>	-	-	-
NS 800/1000	3P / 3P+N	Top / Bottom	-	-	<input checked="" type="checkbox"/>	-	-
NS 1250/1600/1600b/2000	3P / 3P+N	Top / Bottom	-	-	-	<input checked="" type="checkbox"/>	-
Switches							
INS/INV 630b	3P / 3P+N	Top / Bottom	-	<input checked="" type="checkbox"/>	-	-	-
INS/INV 800/1000	3P / 3P+N	Top / Bottom	-	-	<input checked="" type="checkbox"/>	-	-
INS/INV 1250/1600/2000	3P / 3P+N	Top / Bottom	-	-	-	<input checked="" type="checkbox"/>	-
NS 630b NA	3P / 3P+N	Top / Bottom	-	<input checked="" type="checkbox"/>	-	-	-
NS 800/1000 NA	3P / 3P+N	Top / Bottom	-	-	<input checked="" type="checkbox"/>	-	-
NS 1250/1600/1600b/2000 NA	3P / 3P+N	Top / Bottom	-	-	-	<input checked="" type="checkbox"/>	-
MasterPact							
Circuit Breakers							
NT 06	3P / 3P+N	Top / Bottom	-	<input checked="" type="checkbox"/>	-	-	-
NT 08/10	3P / 3P+N	Top / Bottom	-	-	<input checked="" type="checkbox"/>	-	-
NT 12/16	3P / 3P+N	Top / Bottom	-	-	-	<input checked="" type="checkbox"/>	-
NW 08/10	3P / 3P+N	Top / Bottom	-	-	<input checked="" type="checkbox"/>	-	-
NW 12/16/20	3P / 3P+N	Top / Bottom	-	-	-	<input checked="" type="checkbox"/>	-
Switches							
NT 06 HA	3P / 3P+N	Top / Bottom	-	<input checked="" type="checkbox"/>	-	-	-
NT 08/10 HA	3P / 3P+N	Top / Bottom	-	-	<input checked="" type="checkbox"/>	-	-
NT 12/16 HA	3P / 3P+N	Top / Bottom	-	-	-	<input checked="" type="checkbox"/>	-
NW 08/10 NA/HA/HF	3P / 3P+N	Top / Bottom	-	-	<input checked="" type="checkbox"/>	-	-
NW 12/16/20 NA/HA/HF	3P / 3P+N	Top / Bottom	-	-	-	<input checked="" type="checkbox"/>	-
MTZ1 06/HA	3P / 3P+N	Top / Bottom	-	<input checked="" type="checkbox"/>	-	-	-
MTZ1 08/10 HA	3P / 3P+N	Top / Bottom	-	-	<input checked="" type="checkbox"/>	-	-
MTZ1 12/16 HA	3P / 3P+N	Top / Bottom	-	-	-	<input checked="" type="checkbox"/>	-
MTZ2 08/10 NA/HA/HA10	3P / 3P+N	Top / Bottom	-	-	<input checked="" type="checkbox"/>	-	-
MTZ2 12/16/20 NA/HA/HA10	3P / 3P+N	Top / Bottom	-	-	-	<input checked="" type="checkbox"/>	-
TeSys							
Contactors							
GV5, GV7	3P / 3P+N	Top	<input checked="" type="checkbox"/> Upstream only	-	-	-	-
GV6	3P / 3P+N	Top	<input checked="" type="checkbox"/> Upstream only	<input checked="" type="checkbox"/> Upstream only	<input checked="" type="checkbox"/> Upstream only	<input checked="" type="checkbox"/> Upstream only	<input checked="" type="checkbox"/> Upstream only
Others							
Circuit breakers / Switches / Motor circuit breakers							
All products below 200 A	3P / 3P+N	Top / Bottom	<input checked="" type="checkbox"/>	-	-	-	-
All products between 200 A and 600 A	3P / 3P+N	Top / Bottom	-	<input checked="" type="checkbox"/>	-	-	-
All products between 600 A and 1000 A	3P / 3P+N	Top / Bottom	-	-	<input checked="" type="checkbox"/>	-	-
All products between 1000 A and 2000 A	3P / 3P+N	Top / Bottom	-	-	-	<input checked="" type="checkbox"/>	-



Scan untuk
Data Teknis



Scan untuk
Data Teknis



METSECT5CC●●●

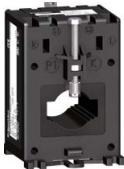

METSECT5ME●●●



METSECT5DA●●●



METSECT5DB●●●



METSECT5DC●●●



METSECT5VW●●●

Current Transformer Solid Core CT Solid Core

Data Teknis

- Arus sekunder (Is) : 5 A
- Rating tegangan maksimal (Ue) : 720 V
- Frekuensi : 50/60 Hz
- Safety factor (sf) : sf < 5 (untuk 40-4000 A)
sf < 10 (untuk 5000-6000 A)
- Indeks proteksi : IP20
- Suhu operasi : -25° C s/d 60° C & -25° C s/d 50°C untuk DB, DC, VV
- Kelembaban relatif : > 95%
- Standard : IEC 61869-2 dan VDE 0414

■ Panorama Produk CT

Ratio CTA (A)	Cable Diameter (mm)	Busbar (mm)	Referensi	Harga (Rp) (Sebelum PPN)	SS
40/5	21	-	METSECT5CC004	494.000	1
50/5	21	-	METSECT5CC005	470.000	1
75/5	21	-	METSECT5CC008	470.000	1
100/5	21	-	METSECT5CC010	448.000	1
125/5	21	-	METSECT5CC013	494.000	1
150/5	21	-	METSECT5CC015	494.000	1
200/5	21	-	METSECT5CC020	494.000	1
250/5	27	-	METSECT5MA025	494.000	1
300/5	27	10 x 32	METSECT5MA030	590.000	2
400/5	27	15 x 25	METSECT5MA040	630.000	1
500/5	40	12 x 50	METSECT5MD050	730.000	1
600/5	40	12 x 50	METSECT5MD060	730.000	1
800/5	-	32 x 65	METSECT5DA080	970.000	1
1000/5	-	32 x 65	METSECT5DA100	1.160.000	1
1250/5	-	32 x 65	METSECT5DA125	1.160.000	2
1500/5	-	32 x 65	METSECT5DA150	1.264.000	2
2000/5	-	38 x 127	METSECT5DB200	1.992.000	1
2500/5	-	38 x 127	METSECT5DB250	2.271.000	1
3000/5	-	38 x 127	METSECT5DB300	2.371.000	2
4000/5	-	52 x 127	METSECT5DC400	2.588.000	1
5000/5	-	55 x 165	METSECT5VV500	13.888.000	2
6000/5	-	55 x 165	METSECT5VV600	23.209.000	2

Current Transformer Solid Core

Dimensi CT Solid Core

■ Dimensi CT (Current Transformer)

METSECT5CC...

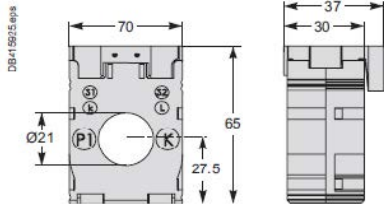

METSECT5MA...

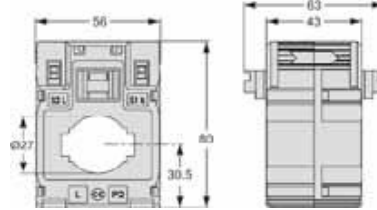

METSECT5MD...

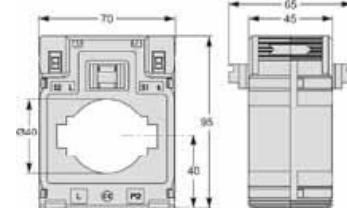

METSECT5DC...

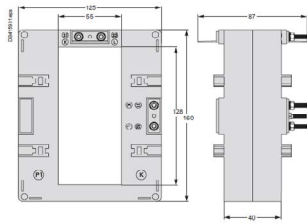

METSECT5DA...

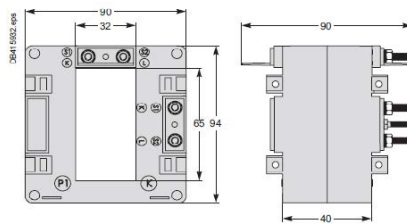

METSECT5DB...

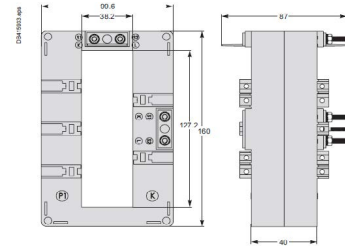

METSECT5VV...

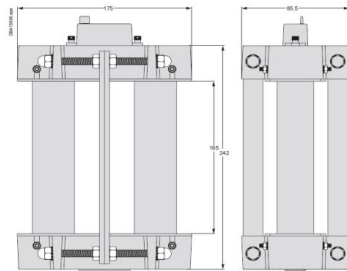



Scan untuk
Data Teknis



METSECT5HA●●●



METSECT5HJ●●●



METSECT5GG●●●



METSECT5GJ●●●

Current Transformer Split Core CT Split Core

Data Teknis

- Arus sekunder (Is) : 5 A
- Rating tegangan maksimal (Ue) : 720 V
- Frekuensi : 50/60 Hz
- Safety factor (sf) : sf < 5 (hingga 1500 A)
sf < 10 (di atas 1500 A)
- Indeks proteksi : IP20
- Suhu operasi : -5°C s/d 50°C (Cable) atau 40°C (Busbar)
- Kelembaban relatif : 5-85%
- Standard : IEC 61869-1 dan IEC 61869-2

■ Panorama Produk CT

Ratio CTA (A)	Cable Diameter (mm)	Busbar (mm)	Referensi	Harga (Rp) <i>(Sebelum PPN)</i>	SS
150/5	18,4	-	METSECT5HA015	2.165.000	2
200/5	18,4	-	METSECT5HA020	2.165.000	2
250/5	18,4	-	METSECT5HA025	2.165.000	2
300/5	27	-	METSECT5HD030	2.165.000	2
400/5	27	-	METSECT5HD040	2.165.000	2
500/5	27	-	METSECT5HD050	2.368.000	2
600/5	32,5	-	METSECT5HG060	2.368.000	2
800/5	42,4	-	METSECT5HJ080	3.102.000	2
1000/5	44	-	METSECT5HP100	3.026.000	2
1200/5	-	85 x 125	METSECT5GG120	4.732.000	2
1250/5	-	85 x 125	METSECT5GG125	4.732.000	2
1500/5	-	85 x 125	METSECT5GG150	4.732.000	2
2000/5	-	85 x 165	METSECT5GJ200	6.625.000	2
2500/5	-	85 x 165	METSECT5GJ250	6.625.000	2
3000/5	-	85 x 165	METSECT5GJ300	6.625.000	2
4000/5	-	85 x 165	METSECT5GJ400	6.625.000	2

Current Transformer Split Core

Dimensi CT Split Core

■ Dimensi CT (Current Transformer)

METSECT5CC...

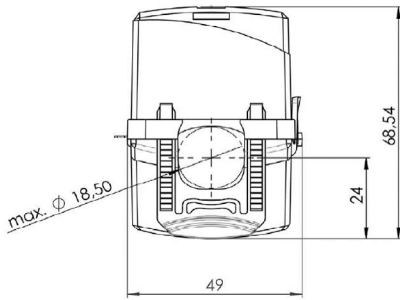

METSECT5MA...

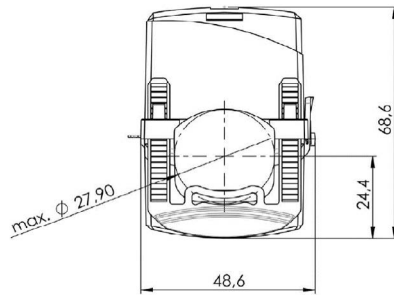

METSECT5MD...

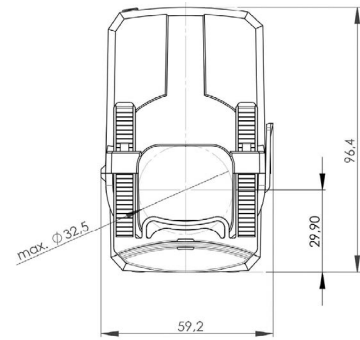

METSECT5HJ...

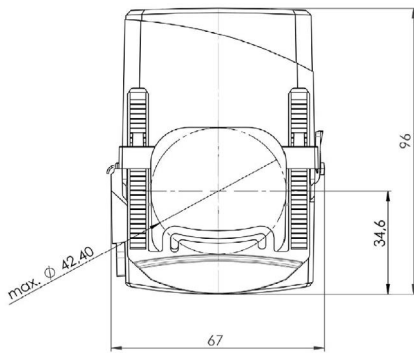

METSECT5HP...

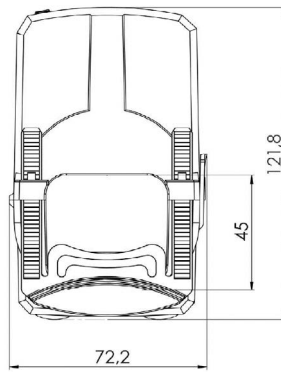

METSECT5GJ...

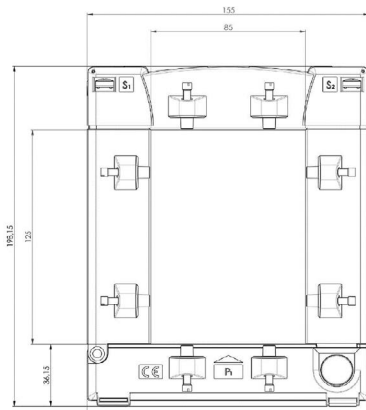

METSECT5GG...

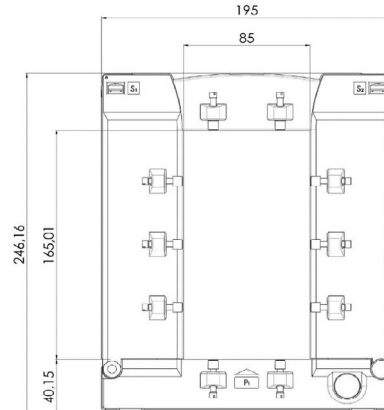



Scan untuk Data Teknis



iEM2050



iEM2455



Scan untuk Data Teknis



iEM3155



iEM3255

Kilowatt Hour Meter Meter Energi Seri iEM

Data Teknis Seri iEM2000

- Kelas akurasi : 1
- Suhu operasi : -10° C s/d 55° C
- Standar : CE certification
- Dimensi & Pemasangan : **iEM2050** : Din Rail (lebar 17.5mm), Direct Connected
iEM2455 : Din Rail (lebar 36 mm), Direct Connected
- Pulsa output : 10000, 2000, 1000, 100, 10, 1, 0.1, 0.01 Pulsa/kwh (untuk fungsi remote transfer)

■ KWh meter 1-fasa

Tipe	Tipe Meter	Tegangan (V)	Rating Arus (A)	Display	Komunikasi	Referensi	Harga (Rp) (Sebelum PPN)	SS
1 Fasa (1P, 1P + N)								
iEM2050	Digital	230Vac	45	6-digit digital	Modbus & Pulse Output	A9MEM2050-TERA	2.184.000	1
iEM2455	Digital	230Vac	100	7-digit digital	Modbus & Pulse Output	A9MEM2455-TERA	5.434.000	1

Data Teknis seri iEM3000

- Kelas akurasi : 1 (iEM31xx) dan 0.5s (iEM32xx)
- Suhu operasi : -25° C s/d 55° C
- Standar : **iEM31●●** : IEC61557-12, IEC 62053-21
iEM32●● : IEC 62053-22
- Display Digital : LCD max: 99999999.9kWh
- Pulsa output : **A9MEM31●●** : (up to) 1000P/kwh
A9MEM32●● : (up to) 500P/kwh
- Dimensi : Din Rail (lebar: 90 mm)

■ KWh meter 3-fasa

Tipe	Rating Arus (A)	Multi Tarif	Komunikasi	Referensi	Harga (Rp) (Sebelum PPN)	SS
3 Fasa (1P + N, 3P, 3P + N) Sambungan Langsung						
iEM3110	63	Tidak	Pulse Output	A9MEM3110-TERA	5.518.000	1
iEM3155	63	4-tariff	Modbus	A9MEM3155-TERA	5.335.000	1
3 Fasa (1P + N, 3P, 3P + N) Menggunakan CT						
iEM3210	Dengan CT 5A	Tidak	Pulse Output	A9MEM3210-TERA	5.558.000	1
iEM3255	Dengan CT 5A	4-tariff	Modbus	A9MEM3255-TERA	5.232.000	1

Catatan :

- Dengan penggunaan CT (dijual terpisah), Arus Primer 40A - 6000A ([lihat hal 12-10](#) atau [12-12](#))
- Harga semua meter tipe iEM yang tertera sudah termasuk biaya dari badan Metrologi Indonesia dan sah untuk dijadikan alat ukur dalam transaksi jual-beli.



Scan untuk
Data Teknis



METSEDM3110



METSEDM1210



METSEDM1310

Digital Meter

Ampere Meter, Volt Meter, dan Frekuensi Meter Digital

Data Teknis

- Kelas akurasi : 0.5 untuk Tegangan dan Arus, 0.2 untuk Frekuensi
- Standard : IEC61000-4-2, IEC61000-4-4, IEC61000-4-5, EC60060
- Display : 4 digit LED
- Suhu operasi : -10 C s/d 60 C
- Dimensi : 96 x96, cutout 92X92
- Ratio CT & PT : Adjustable

Fasa	Operating Range	Referensi	Harga (Rp) (Sebelum PPN)	SS
Ampere Meter Digital				
1	50mA-6A	METSEDM1110	550.000	2
3	50mA-6A	METSEDM3110	672.000	2
Volt Meter Digital				
1	44-480 VAC	METSEDM1210	540.000	2
3	80-480 VAC _{LL}	METSEDM3210	622.000	2
Frekuensi Meter Digital				
1	20-100 Hz	METSEDM1310	775.000	2

Digital Meter dan Power Meter

Digital Meter Seri DM6200H dan Power Meter Seri PM2000



Scan untuk
Data Teknis

Spesifikasi Umum

- Mengukur parameter kelistrikan standar (Arus, Tegangan, Frekuensi, Faktor Daya, Daya, dan Energi).
- Dilengkapi dengan LED atau LCD untuk memudahkan pembacaan.
- Dimensi : 96 x 96, cutout : 92 x 92
- Adjustable CT & PT Ratio



Spesifikasi	DM6200H	PM2120	PM2220	PM2230
Pengukuran				
Arus (Fasa dan Netral)	√	√	√	√
Tegangan (Rata-rata, Fasa-Fasa, dan Fasa-Netral)	√	√	√	√
Frekuensi	√	√	√	√
Faktor Daya (Rata-rata dan per Fasa)	√	√	√	√
Daya (Total dan per Fasa)		√	√	√
Energi (Aktif, Reaktif, Nyata)		√	√	√
THD (Arus dan Tegangan)		√	√	√
Kelas akurasi				
Arus	1	0,5	0,5	0,5
Tegangan	1	0,5	0,5	0,5
Daya Aktif		0,5	0,5	0,5
Daya Reaktif		1	1	1
Energi Aktif		1	1	0,5S
Energi Reaktif		1	1	1
Spesifikasi Lain				
LCD	LED 7-Segment	LED 7-Segment	Monochrome	Monochrome
Resolusi LCD	-	-	128 x 128	128 x 128
Modbus Serial (RS485)	√	√	√	√

Deskripsi	Nama Produk	Referensi	Harga (Rp) (Sebelum PPN)	SS
Digital Meter Seri 6200 H dengan Komunikasi	DM6200H	METSEDM6200HCL10RS	1.877.000	2
Power Meter Seri 2000 LED dengan Komunikasi	PM2120	METSEPM2120	3.902.000	1
Power Meter Seri 2000 LCD dengan Komunikasi	PM2220	METSEPM2220	6.039.000	1
Power Meter Seri 2000 LCD dengan Komunikasi dan Akurasi 0.5S	PM2230	METSEPM2230	6.391.000	1

Power Meter

Power Meter Seri PM5000 & PM8000

■ Data Teknis Power Meter Seri PM5000 & PM8000

Spesifikasi	PM5350	PM5110	PM5330	PM5560	PM5650	PM5760	PM8240
							
Kelas Akurasi							
Arus (total, fasa, dan netral)	0,5	0,5	0,5	0,15	0,15	0,15	0,1
Tegangan	0,5	0,5	0,5	0,1	0,1	0,1	0,1
Daya aktif	0,5	0,5	0,5	0,2	0,2	0,2	0,2
Energi aktif	0,5 s	0,5 s	0,5 s	0,2 s	0,2s	0,2s	0,2s
Energi reaktif	2	2	2	1	1	1	0,5s
Sampling rate (samples/cycle)	32	64	64	128	128	128	256
Pengukuran							
Arus (total, fasa, dan netral)	√	√	√	√	√	√	√
Tegangan (total, ph-ph, dan ph-netral)	√	√	√	√	√	√	√
Frekuensi	√	√	√	√	√	√	√
Faktor daya (total dan per fasa)	√	√	√	√	√	√	√
Daya/fasa (aktif, reaktif, dan nyata)	√	√	√	√	√	√	√
Total daya (aktif, reaktif, dan nyata)	√	√	√	√	√	√	√
Energi (aktif, reaktif, dan nyata)	√	√	√	√	√	√	√
THD (arus dan tegangan)	√	√	√	√	√	√	√
TDD (Total Demand Distortion)	-	√	√	√	√	√	√
Individual Harmonik hingga orde	15	15	31	63	63	63	63/127 ⁽²⁾
Analisa kualitas daya							
Harmonik individu (arus dan tegangan)	15	15	31	63	63	63	63
Waveform capture	-	-	-	-	√	√	√
Deteksi sag/swell	-	-	-	-	√	√	√
Analisa EN50160	-	-	-	-	-	-	√
Residual Current Monitoring (RCM)	-	-	-	-	-	√	-
Disturbance Direction Detection (DDD) ⁽³⁾	-	-	-	-	-	-	√
I/O dan komunikasi							
Digital Input	4	-	2	4	4	2	3
Digital output	-	1	2	2	2	2	1
Relay output	2	-	2	-	-	-	-
Modbus Serial (RS485)	√	√	√	√	√	√	√
Modbus TCP (Ethernet)	-	-	-	√ ⁽¹⁾	√ ⁽¹⁾	√ ⁽¹⁾	√ ⁽¹⁾
Ethernet Gateway	-	-	-	√	√	√	√
Protokol DNP3, IEC 61850	-	-	-	-	-	-	√
Spesifikasi lain							
LCD	Monochrome	Monochrome	Monochrome	Monochrome	Monochrome	Berwarna	Berwarna
Resolusi LCD	128 x 128	128 x 128	128 x 128	128 x 128	128 x 128	128 x 128	320 x 320
Kapasitas memori	-	-	256 kB	1,1 MB	1,1 MB	1,1 MB	512 MB
Alarm	40	33	35	52	54	56	50 +
Multi Tarif	-	-	4	8	8	8	-
Data Logging For Parameters	-	-	√	√	√	√	√
HTTP Web Server	-	-	-	√	√	√	√
Trending and forecasting	-	-	-	-	-	-	√

Catatan :

- (1) Double Ethernet port dengan 1 alamat IP untuk mempermudah instalasi TCP/IP dengan system daisy chain
- (2) Individual harmonik default hingga orde 63. Dengan Software PME hingga orde 127
- (3) Disturbance Direction Detection merupakan teknologi yang dipatenkan oleh Schneider yang mampu mendeteksi arah gangguan. Fitur ini hanya bisa diakses melalui software PME

■ Power Meter seri PM5000 & PM8000

Deskripsi	Nama Produk	Referensi	Harga (Rp) (Sebelum PPN)	SS
PM5350 Modbus RS-485 Acc 0.5S, 15th H	PM5350	METSEPM5350	8.570.000	1
PM5110 Modbus RS-485 Acc 0.5S, 15th H	PM5110	METSEPM5110	8.739.000	1
PM5330 Modbus RS-485 Acc 0.5S, 31st H, Multi Tariff	PM5330	METSEPM5330	11.794.000	1
PM5560 Modbus ETH Acc 0.2s, 63rd H, Multi Tariff	PM5560	METSEPM5560	19.757.000	1
PM5650 Modbus ETH Acc 0.2s, 63rd H, WF capture & sag/swell, Multi Tariff	PM5650	METSEPM5650	26.361.000	2
PM5760 Modbus ETH Acc 0.2s, 63rd H, WF capture & sag/swell, RCM, Multi Tariff	PM5760	METSEPM5760	30.389.000	2
PM8000 Modbus ETH Acc 0.2s, 127th H3), WF capture & sag/swell, DDD	PM8240	METSEPM8240	42.237.000	1

■ Aksesori tambahan I/O PM8000

Deskripsi	Referensi	Harga (Rp) (Sebelum PPN)	SS
Analogue I/O module (4 analogue inputs & 2 analogue outputs)	METSEPM89M0024	17.860.000	2



Scan untuk Data
Teknis PM5000



Scan untuk Data
Teknis PM8000



Scan untuk
Data Teknis



METSEION92040

Power Meter

Power Meter Seri ION9000

■ Power Logic ION9000

Power Meter Seri ION9000 merupakan Power Quality Meter inovatif yang memiliki kelas akurasi terbaik: 0.1s, desain yang modular, programabilitas khas ION Meter yang fleksibel, dan analisis kualitas daya yang paling lengkap dan canggih.

PowerLogic ION9000 adalah Meter yang sempurna untuk Industri, Fasilitas Kesehatan, Data Center, jaringan utilitas, dan bisnis kritikal lainnya.

Deskripsi	Referensi	Harga (Rp) (Sebelum PPN)	SS
PowerLogic ION9000	METSEION92040	148.168.000	2

■ Spesifikasi

Spesifikasi	ION9000
Kelas Akurasi	
Arus	0.1
Tegangan	0.1
Daya aktif dan reaktif	0.1
Energi aktif	0.1s
Energi reaktif	0.5s
Sampling rate (samples/cycle)	1024
Pengukuran	
Arus (total, fasa, dan netral)	✓
Tegangan (total, ph-ph, dan ph-netral)	✓
Frekuensi	✓
Faktor daya (total dan per fasa)	✓
Daya/fasa (aktif, reaktif, dan nyata)	✓
Total daya (aktif, reaktif, dan nyata)	✓
Energi (aktif, reaktif, dan nyata)	✓
Analisa kualitas daya	
Individual Harmonik hingga orde	63 / 511 *)
THD (arus dan tegangan)	✓
TDD (Total Demand Distortion)	✓
Deteksi High Speed Transient: 10 MHz (200k s/c @50Hz)	-
Deteksi sag/swell	✓
Deteksi Flicker	✓
Deteksi Transient	✓
Analisa EN 50160	✓
Disturbance Direction Detection	✓
I/O dan komunikasi	
Digital input	8
Digital output	4
Relay Output	2
Modbus Serial (RS485)	2 Port
Modbus TCP (Ethernet)	Dual Ethernet
Ethernet Gateway	✓
Protokol DNP3, IEC 61850, DLMS	✓
Spesifikasi lain	
LCD	Berwarna. Grafis.
Resolusi LCD (pixel)	800 x 480
Memori Internal	2GB
Data Logging for parameters	✓
HTTP web server	✓
Trending and forecasting	✓

Catatan :

*) Individual harmonik default hingga orde 63. Dengan Software PME hingga orde 511



Scan untuk Data Teknis



PAS600L / PAS800L

Ethernet Gateway & Energy Server

EcoStruxure Panel Server

EcoStruxure Panel Server

merupakan Ethernet Gateway baru yang juga dilengkapi dengan fungsi pembacaan (concentrator) sensor wireless.

Spesifikasi	ESX Panel Server Universal	ESX Panel Server Advanced
	PAS600L	PAS800L
Power Supply	24 VDC	24 VDC
Ethernet Communication	2 RJ45 ports	2 RJ45 ports
Downstream Modbus Serial connectivity	✓	✓
Downstream Modbus TCP/IP connectivity	✓	✓
Downstream PowerTag & Wireless devices connectivity	✓	✓
Upstream Modbus TCP/IP connectivity (edge connection)	✓	✓
Cellular connectivity to cloud through an optional external module	✓	✓
Digital inputs (including WAGES)	2	2
Data logging	-	✓
Commissioning tool	<ul style="list-style-type: none"> EcoStruxure Power Commission software EcoStruxure Panel Server webpages 	

EcoStruxure Panel Server

Deskripsi	Referensi	Harga (Rp) (Sebelum PPN)	SS
EcoStruxure Panel Server - Universal	PAS600L	10.132.000	1
EcoStruxure Panel Server - Advanced, dengan Datalogging	PAS800L	15.308.000	1

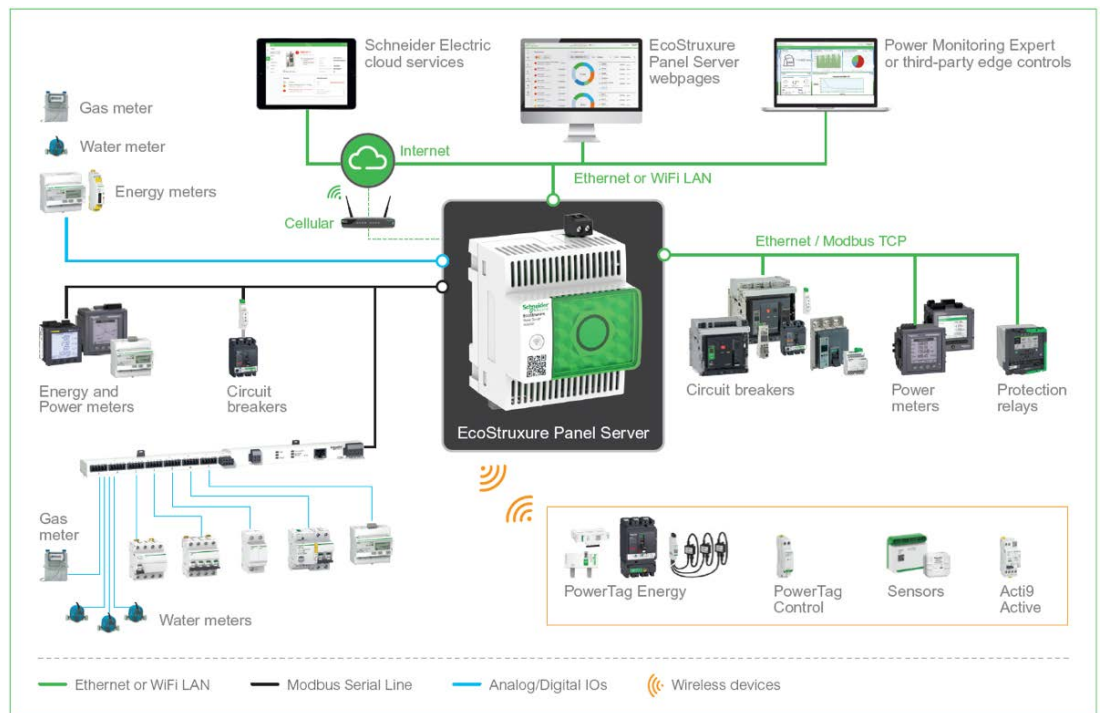



Life Is On

Schneider
Electric

Panel Industri & Kontrol Temperatur

Panduan Baca Referensi	13-3
Indeks Proteksi Panel Schneider	13-4
Standard dan Sertifikasi Panel Schneider	13-5
Industrial Box	13-6
Panel Tembok (Wall Mounted)	13-7
Panel Spacial CRN (Bahan Besi)	13-7
Panel Thalassa PLM (Bahan Fiberglass-Reinforced Polyester)	13-8
Panel Spacial S3X (Bahan Stainless-steel)	13-9
Aksesori Panel Tembok (Wall Mounted)	13-10
Sistem Ventilasi Panel	13-11
Sistem Pemanas Panel	13-12
Sistem Kontrol Temperatur Panel	13-13
Linergy TR - Terminal Blok & Aksesori Kabel	13-14
Spesifikasi Terminal Blok	13-14
Aneka tipe Terminal Blok	13-15
Tipe Sekrup / Screw	13-16
Tipe Earth & Aksesori	13-17
Cable End	13-18
Single Conductor (standard NF C 63-023)	13-18

Scan QR untuk Software Pendukung



Spacial Conf



Konfigurasi Panel



Kalkulasi Panas

Panduan Baca Referensi

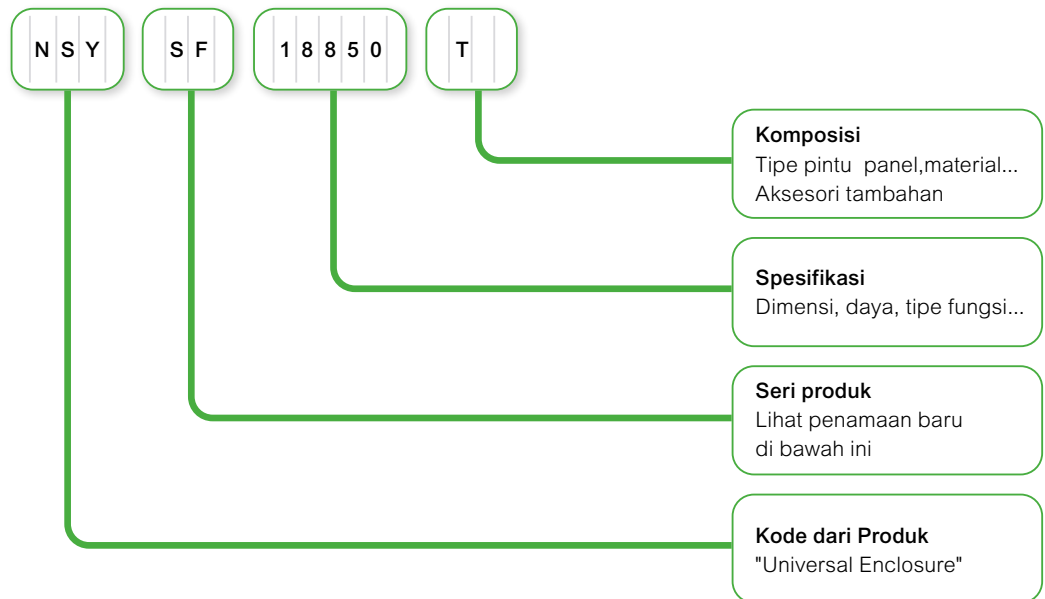

Nama Baru dari Seri Produk

ClimaSys (Manajemen Panas)

- ClimaSys CV** Sistim Ventilasi (FAN)
- ClimaSys CU** Unit Pendingin (Cooling)
- ClimaSys CE** Penukar Panas (Heat Exhenger)
- ClimaSys CR** Pemanas (Heaters)
- ClimaSys CC** Kendali Panas (Thermal Control)

Thalassa (Insulating Enclosures)

- Thalassa TBP** Box Industrial PC (UL)
- Thalassa PLS** Box Modular (Modular Box)
- Thalassa PLM** Panel Tembok Bahan Polyester
- Thalassa PLA** Panel Berdiri Bahan Polyester

LYNERGY TR Terminal Blok

- NSYTRV** Terminal Blok Sekrup
- NSYTRR** Terminal Blok Pegas
- NSYTRP** Terminal Blok Tekan
- NSYTRAB** Label untuk Terminal Blok

Spacial (Bahan Metal /Steel)

- Spacial SDM** Box Industri (Steel)
- Spacial CRN/G** Panel Tembok (Steel)
- Spacial S3HD** Panel Tembok Outdoor (Steel)
- Spacial SF** Panel Berdiri Suitable (Steel)
- Spacial SM** Panel Berdiri ComPact (Steel)
- Spacial SFHD** Panel Berdiri Outdoor (Steel)
- Spacial S3D** Panel Control Desk (Steel)
- Spacial S3CM** Panel HMI Control

Spacial (Bahan Stainless-Steel)

- Spacial S3X** Panel Tembok
- Spacial SFX** Panel Berdiri Suitable
- Spacial SMX** Panel Berdiri Monoblok
- Spacial SDX** Panel Control Desk

PPUES

Name	Range	IP43	IP44	IP54	IP55	IP65 (7)	IP66
Metal industrial boxes	Spacial SBM						●
Metal derivation boxes	Spacial SDB				●		
Stainless-steel boxes	Spacial SBX						●
Steel wall-mounted enclosures	Spacial S3D				● (1)		●
Steel modular distribution wall-mounted enclosures	Spacial S3DM						●
Terminal wall-mounted enclosures	Spacial S3DB						●
Steel wall-mounted enclosures	Spacial S3HF				●		
Steel wall-mounted enclosures	Spacial CRN						●
Steel wall-mounted enclosures	Spacial CRNG				● (1)		●
EMC steel floor-standing enclosures	Spacial SFHF				●		
HMI control enclosures	Spacial S3CM			●			
ATEX steel wall-mounted enclosures	Spacial S3DEX						●
Steel outdoor wall-mounted enclosures	Spacial S3HD						●
Stainless-steel wall-mounted enclosures	Spacial S3X				● (1)		●
Seismic and nuclear enclosures	Spacial S3D6G / Spacial S3D6GK3					●	
Terminal enclosures with FL21 cut-out	Spacial S3DBFL					● (6)	
Steel floor-standing enclosures	Spacial SM				●		
Steel suitable enclosures	Spacial SF				●		
Steel outdoor floor-standing enclosures	Spacial SFHD				●		
Stainless-steel floor-standing enclosures	Spacial SMX						● (7)
Stainless-steel suitable enclosures	Spacial SFX						● (7)
Functional steel floor-standing enclosures	PrismaSeT HD				●		
Steel control desks	Spacial SD				●		
Stainless-steel control desks	Spacial SDX				●		
Thermoplastic industrial boxes	Thalassa TBS-TBP				● (4)		● (5)
Polyester modular boxes	Thalassa PLS						●
Polyester wall-mounted enclosures	Thalassa PLM						●
Polyester outdoor wall-mounted enclosures	Thalassa PHD					●	
Polyester floor-standing enclosures	Thalassa PLA (2)		●	●		●	
Polyester floor-standing enclosures	Thalassa PLD	●		● (3)			
Polyester outdoor floor-standing enclosures	Thalassa PHD				●		

Catatan :

- (1) Double door.
- (2) Different IP depending on the version. See introduction in Thalassa section:
- PLA: IP65, PLAT / PLA.ZT: IP44, PLAZ / PLAT /
- PLAZT with grille: IP54.
- (3) With gasket.
- (4) Button boxes.
- (5) Universal boxes.
- (6) With membrane mounted.

(7) Single-door enclosure.

IP Degree of Protection

First numeral

Protection against solid bodies

0



No protection

1



Protected against solid bodies larger than 50 mm (e.g.: incidental contact with the hand)

2



Protected against solid bodies larger than 12 mm (e.g.: Finger contact)

3



Protected against solid bodies larger than 2.5 mm (tools, cables)

4



Protected against solid bodies larger than 1 mm (fine tools, small cables)

5



Protected against dust (no harmful deposits)

6



Totally dust tight

Second numeral

Protection against liquids

0



No protection

1



Protected against vertically falling water droplets (condensation)

2



Protected against water droplets deflected at up to 15° from vertical

3



Protected against rainwater at up to 60° from vertical

4



Protection against water spray from all directions

5



Protected against low-pressure water jets from all directions

6



Protected against powerful water jets from all directions

7

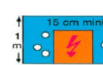

Protected against the effects of immersion

8













Protected against prolonged effects of immersion under pressure

PPUES

■ Aim of the certification						
Range	International standard for electric power enclosures	Standards for industrial equipment and UL classification	Marine environment classification or approval for protection and resistance to vibrations	ATEX	Outdoor Heavy Duty	Low-voltage switch-gear and control-gear assemblies
	Standard/Directive IEC 62208	UL508A and CAN CSA C22-2 no. 14	Rules of certifying bodies	European directive no. 94/9/EC EN 60079-0 and -7 EN 61241-0 and -1	IEC 61439-5 ISO 12.944 IEC 61969-3	IEC 61439-1&2
Spacial						
SF	● ●	●	● ●			
SFHD	● ●	●			●	
SFP						●
SFM						●
SM	● ●	●	●			
S3D	● ●	●	● ● ● ●	● (1)		
S3HD	●	●			●	
S3CM		●				
CRN	● ●	●	●			
SBM	●	●	● ● ● ●			
SFX				● (4)		
SMX	●	●	●	● (4)		
S3X	●	●	●		● (1)	
Thalassa						
PLA	● ●	●	●			
PLAT	● ●					
PLAZ	● ●					
PLATZ	● ●					
PLD	●					
PHD	●	●			●	
PLM	● ●	●	●	●	● (1)	
PLS	●	● (3)				
TBS/TBP	●	● (2)				
ClimaSys						
CV		●				
CU		●				
CE		●				
CR		●				
CC		●				

- Catatan :**
 (1) ATEX certifications relate to adapted part of the range. These ranges are distinguished by their EX endings.
 (2) Only TBP.
 (3) Transparent cover in process.
 (4) Only for 1 door versions.

Certification Body										
●	●	●	●	●	●	●	●	●	●	●
Bureau Veritas	Dekra	TUV Rheinland Group	Underwriters Laboratories	Bureau Veritas Marine Division	LCIE (Bureau Veritas)	Det Norske Veritas	Germanischer Lloyd	Laboratorio Official J.M. Madariaga	Lloyd's Register	Asefa
										



Scan untuk
Data Teknis



Transparent ●●T



Cover Tinggi ●●H

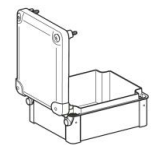

Tersedia kit engsel box
(hinges)

TERSEDIA



Scan untuk
Data Teknis

Panel Industrial Panel Thalassa - ABS & Polycarbonate

■ Panorama Produk bahan ABS

Data Teknis

- Indeks Proteksi : IP 66 / NEMA 4.4X
IK07 (IEC 62262)
- Suhu Instalasi : -15° C s/d 40° C
- Suhu Operasi : -25° C s/d 60° C
- Ketahanan Glow Wire : 650° C
- Warna Body / Cover : RAL 7035 / RAL 7035 grey or tinted transparent
- Standard & Sertifikasi : IEC 62208, SEMKO, DEMKO. UL, TÜV, NEMA 4.4X
(NEMA 250), Self-extinguishing: UL 94 V-0, Class II
According to IEC 61140

Dimensi Eksternal			Referensi Cover Solid	Harga (Rp) (Sebelum PPN)	SS
Tinggi	Lebar	Dalam			
192	164	87	NSYTBS19168	520.000	2
		105	NSYTBS191610H	665.000	2
241	194	107	NSYTBS241910	891.000	2
		127	NSYTBS241912H	937.000	2
291	241	128	NSYTBS292412	1.193.000	2
		168	NSYTBS292416H	1.527.000	2
341	291	128	NSYTBS342912	1.542.000	2
		168	NSYTBS342916H	1.807.000	2

NSYTB●●●T > Cover Transparant

NSYTB●●●H > Cover Tinggi 40 atau 60 mm, Tidak Transparant

NSYTB●●●HT > Cover Tinggi & Transparant

■ Panorama Poduk Box PC (Polycarbonate)

Data Teknis

- Indeks Proteksi : IP 66 / NEMA 4.4X
IK08 (IEC 62262)
- Suhu Instalasi : -15°C s/d 60°C
- Suhu Operasi : -25°C s/d 80°C
- Ketahanan Glow Wire : 960°C
- Warna Body / Cover : RAL 7035 / RAL 7035 grey or tinted transparent
- Standard & Sertifikasi : IEC 62208, SEMKO, DEMKO. UL, TÜV, NEMA 4.4X
(NEMA 250) UL 508A, Self-extinguishing: UL 94 V-0,
Class II (IEC 61140)

Dimensi Eksternal			Referensi Cover Solid	Harga (Rp) (Sebelum PPN)	SS
Tinggi	Lebar	Dalam			
192	164	87	NSYTBP19168	805.000	2
		105	NSYTBP191610H	896.000	2
241	194	127	NSYTBP241912H	1.204.000	2
		128	NSYTBP292412	1.786.000	2
291	241	168	NSYTBP292416H	2.233.000	2
		128	NSYTBP342912	Hub kami	
341	291	168	NSYTBP342916H	2.699.000	2

Catatan : Untuk kebutuhan industrial box dengan dimensi yang lain, ataupun cover transparan, silakan hubungi kami



Scan untuk
Data Teknis



CRN
3-mm standard
double-bar lock



CRNG
Three-point locking for 1
or 2 doors. Standard 5-mm
double-bar lock



+Mount Plate ●●P



+Pintu Kaca ●●T



Double Door

TERSEDIA

Panel Tembok (Wall Mounted)

Panel Spacial CRN (Bahan Besi)

Data Teknis

- Mounting : Tembok (Wall Mounted)
- Indeks proteksi : IP 66 untuk panel dengan 1 pintu
IP 55 untuk panel dengan 2 pintu untuk pintu polos
- Warna : RAL 7035 (Grey)
- Standar : IEC 62208, UL, CUL, BV, DNV, GL, RoHS
- Material : Besi

■ Panorama Produk CRN & CRNG

Tinggi	Ukuran (mm)		Jumlah Pintu	Referensi	Harga (Rp) (Sebelum PPN)	SS
	Lebar	Dalam				
300	250	150	1	NSYCRN325150	1.476.000	2
	300	200	1	NSYCRN33200	1.538.000	2
	400	200	1	NSYCRN34200	1.771.000	2
400	300	200	1	NSYCRN43200	1.620.000	1
		200	1	NSYCRN43200P	2.112.000	2
	200	1	NSYCRN43200T	Hub kami		
500	400	200	1	NSYCRN54200	2.160.000	2
		250	1	NSYCRN54250	2.286.000	2
	200	1	NSYCRN64200	2.423.000	2	
600	400	200	1	NSYCRN64200P	Hub kami	
		250	1	NSYCRN64250	2.522.000	2
	250	1	NSYCRN66250	3.633.000	2	
700	600	300	1	NSYCRN66300	3.525.000	2
		200	1	NSYCRN75200	3.419.000	2
	250	1	NSYCRN75250	3.556.000	2	
800	600	200	1	NSYCRN86200	4.227.000	2
		250	1	NSYCRN86250	4.183.000	2
	300	1	NSYCRN86300	5.111.000	2	
1000	600	400	1	NSYCRNG86400	Hub kami	
		250	1	NSYCRN106250	5.647.000	2
	800	1	NSYCRN108300	6.685.000	2	
1200	800	400	1	NSYCRNG108400	Hub kami	
		300	1	NSYCRNG128300	10.467.000	2
	400	1	NSYCRNG128400	10.755.000	2	

NSYCRN●●●T > Panel dengan Pintu Transparan

NSYCRN●●●P > Panel dengan Mounting Plate

NSYCRNG●●●D > Panel dengan dua daun pintu (Double Door)

Catatan :

- Untuk kebutuhan panel dengan pintu kaca, dimensi yang lain, panel kosong dengan chassis, serta panel stainless steel dan panel dengan sertifikasi ATEX, silakan hubungi kami.
- Tersedia juga Aksesori panel wall mounted lainnya, silakan hubungi kami.
- Tersedia panel dengan material stainless steel 304L maupun 316L, silakan hubungi kami



Scan untuk
Data Teknis



NSYPLM32G
(Bahan ABS/PC)



Thalassa
NSYPLM●●



TERSEDIA
Pintu Transparan
NSYPLM●●TG



Pintu Dalam

Panel Tembok (Wall Mounted)

Panel Thalassa PLM (Bahan Fiberglass-Reinforced Polyester)

Data Teknis

- Mounting : Tembok (Wall Mounted)
- Indeks proteksi : IP 66, IK 10 (pintu steel) & IK 08 (pintu kaca)
- Suhu : - 50° C s/d +150° C (Polyester)
- 35° C s/d +90° C (Gasket)
- Warna : RAL 7035 (Grey)
- Standar : IEC 62208, NEMA 4X & 13, Marine, UL 508A, RoHS, REACH
- Material : Polyester diperkuat dengan Fiberglass (hot compression)

■ Panorama Produk Thalassa PLM

Ukuran (mm)			Material	Jumlah Pintu	Referensi	Harga (Rp) (Sebelum PPN)	SS
Tinggi	Lebar	Dalam					
310	215	160	ABS/PC	1	NSYPLM32G ^{*)}	1.692.000	2
308	255	160	Polyester	1	NSYPLM3025G	2.680.000	2
430	330	200	Polyester	1	NSYPLM43G	2.878.000	2
530	430	200	Polyester	1	NSYPLM54G	3.579.000	2
647	436	250	Polyester	1	NSYPLM64G	4.676.000	2
747	536	300	Polyester	1	NSYPLM75G	6.446.000	2
847	636	300	Polyester	1	NSYPLM86G	7.896.000	2
1056	852	350	Polyester	1	NSYPLM108G	17.086.000	2

^{*)} Material ABS/PC

NSYPLM●●●TG > Panel dengan Pintu Transparan (IK08)

NSYPLM●●●VG > Panel dengan Pintu standard dengan 3 point closure

NSYPLM●●●TVG > Panel dengan Pintu Transparan dengan 3 point closure

Catatan :

- Untuk kebutuhan panel dengan pintu kaca, dimensi yang lain, panel kosong dengan chassis, dan panel dengan sertifikasi ATEX, silakan hubungi kami.
- Tersedia juga Aksesori panel wall mounted lainnya, silakan hubungi kami.

■ Pintu Dalam

Ukuran (mm)			Referensi	Harga (Rp) (Sebelum PPN)	SS
Tinggi	Lebar	Dalam			
308	255	-	NSYPA3025PLMG	1.799.000	2
430	330	-	NSYPAP43G	1.280.000	2
530	430	-	NSYPAP54G	1.417.000	2
645	435	-	NSYPAP64G	1.511.000	2
745	535	-	NSYPAP75G	Hub Kami	
845	635	-	NSYPAP86G	2.292.000	2
1055	850	-	NSYPAP108G	3.178.000	2



Scan untuk
Data Pendukung

Panel Tembok (Wall Mounted) Panel Spacial S3X (Bahan Stainless-Steel)

Data Teknis

- Mounting : Tembok (Wall Mounted)
- Indeks proteksi :
 - IP 66 untuk panel dengan 1 pintu
 - IP 55 untuk panel dengan 2 pintu
 - IK 10 untuk pintu polos
 - IK 08 untuk pintu kaca
- Warna : Stainless-steel tanpa cat
- Standar :
 - IEC 62208, UL 508A, CAN/CSA 22
 - NEMA : 1 door enclosure: type 1, 2, 3, 3R, 4, 4X, 5, 12, 13
 - NEMA : 2 doors enclosure: type 1, 12, 12K
- Material : Stainless-steel Type 304L (Opsional type 316L)

■ Panorama Spacial S3X Stainless Steel Wall Mounted

Tinggi	Ukura n (mm)		Jumlah		Referensi	Harga (Rp) (Sebelum PPN)	SS
	Lebar	Dalam	Lock *	Pintu			
300	200	150	1	1	NSYS3X3215	6.732.000	2
	250	150	1	1	NSYS3X302515	7.167.000	2
	300	150	1	1	NSYS3X3315	7.882.000	2
400	300	150	1	1	NSYS3X4315	8.041.000	2
	300	200	1	1	NSYS3X4320	9.834.000	2
	400	200	1	1	NSYS3X4420	9.801.000	2
500	600	200	1	1	NSYS3X4620	15.527.000	2
	400	200	2	1	NSYS3X5420	11.492.000	2
	400	200	2	1	NSYS3X6420	11.915.000	2
600	600	250	2	1	NSYS3X6625	20.961.000	2
	600	250	2	1	NSYS3X6625H	25.659.000	2
	500	250	2	1	NSYS3X7525	23.608.000	2
700	500	250	2	1	NSYS3X7525T	27.171.000	2
	600	250	2	1	NSYS3X8625	26.740.000	2
	800	300	2	1	NSYS3X8830	39.427.000	2
1000	800	300	2	1	NSYS3X10830	34.172.000	2
	1000	300	***	2	NSYS3X101030	Hub kami	
1200	800	300	2	1	NSYS3X12830	37.008.000	2
	1000	300	***	2	NSYS3X121030	Hub kami	

*) Jumlah Locking points

***) Three-point Lock closure system

NSYS3X●●●●T > Panel dengan Pintu Transparan (Securit® glass, 4 mm thick)

NSYS3X●●●●D > Panel dengan dua daun pintu (Double Door)

NSYS3X●●●●H > Panel dengan Stainless-steel type 316L (Marine Grade)

Catatan :

- Untuk kebutuhan panel dengan pintu kaca, dimensi yang lain, panel kosong dengan chassis, serta panel stainless steel dan panel dengan sertifikasi ATEX, silakan hubungi kami
- Tersedia juga Aksesoris panel wall mounted lainnya, silakan hubungi kami

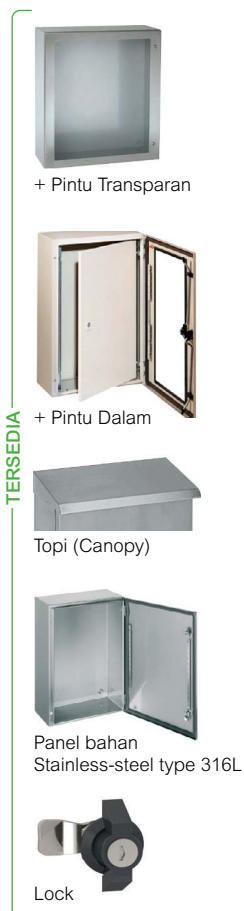



Scan untuk Data Sheet Mounting Plate



Telequick



Microperfor



Polyester



Modular

TERSEDIA

Panel Tembok (Wall Mounted)

Aksesori - Mounting Plate

■ Mounting Plate Polos

Digunakan untuk Panel	Ukuran Mounting Plate (mm)		Referensi Mounting Plate	Harga (Rp) <i>(Sebelum PPN)</i>	SS
	Tinggi	Lebar			
NSYPLM32	250	150	NSYMM32	157.000	2
NSYPLM3025	250	200	NSYMM3025	246.000	2
NSYPLM43	230	350	NSYMM43*	246.000	2
NSYPLM54	450	350	NSYMM54	425.000	1
NSYPLM64	550	350	NSYMM64*	512.000	2
NSYPLM75	650	450	NSYMM75	722.000	2
NSYPLM86	750	550	NSYMM86*	1.196.000	2
NSYPLM108	950	750	NSYMM108*	1.743.000	2

*) Bisa digunakan secara horizontal untuk panel dengan ukuran terbalik.



Scan untuk
Data Pendukung

Data Teknis

- Indeks proteksi : IP 54
- Warna : RAL 7035 (option RAL 7032)
- Standar : UL94 V-0 (Self Exthinguishing)
- Material : Injected Thermoplastic (ASAPC)

■ Panorama Produk Fan

Dimensi Cut Out	Flow Rate (m3/h)	Tegangan	Referensi Fan FAN + Grille	Harga (Rp) (Sebelum PPN)	SS	Referensi Exhaust Grille	Harga (Rp) (Sebelum PPN)	SS
92x92	38	230 V AC	NSYCVF38M230PF *	1.260.000	1	NSYCAG92LPF	367.000	2
	58	24 V DC	NSYCVF38M24DPF	1.311.000	2			
125x125	85	230 V AC	NSYCVF85M230PF	1.517.000	1	NSYCAG125LPF	373.000	1
	80	24 V DC	NSYCVF85M24DPF	Hub kami	2			
	165	230 V AC	NSYCVF165M230PF	1.827.000	1			
223x223	188	24 V DC	NSYCVF165M24DPF	Hub kami	2	NSYCAG223LPF	567.000	1
	302	230 V AC	NSYCVF300M230PF	2.613.000	1			
	262	24 V DC	NSYCVF300M24DPF	Hub kami	2			
	562	230 V AC	NSYCVF560M230PF	8.109.000	1			
291x291	838	230 V AC	NSYCVF850M230PF	9.471.000	1	NSYCAG291LPF	901.000	2

Catatan :

- Fan sudah dilengkapi outlet grill dan filter debu standar
- Untuk kebutuhan produk pendingin panel lainnya (Air-air exchanger, air-water exchanger, ataupun cooling unit) yang memungkinkan untuk dipasang di atas/samping panel, silakan hubungi kami

⚠ *) Warning: Fan NSYCVF38M230PF & NSYCVF38M115PF tidak untuk dikoneksikan ke power conversion module, inverter atau UPS type of power supply!



Fan 38 m³/h



Fan 85 m³/h



Fan 165-300 m³/h



Fan 560-850 m³/h



IP5 4 Exhaust Grille



Scan untuk
Data Sheet IP54
Exhaust Grille



Scan untuk
Data Pendukung



PTC Heater



Heater + Fan



Insulated Heater



Insulated Heater + Fan

Sistem Pemanas Panel

Data Teknis

- Material : • Extruded Aluminium (Body)
• Plastic cover (Tipe Berinsulasi)
- Indeks proteksi : IP20
- Tipe : PTC (Positive Temp Coefficient)
- Fixing Mode : by Clips
- Mounting : 35 mm DIN Rail
- Standard : CE, UL & VDE

■ Panorama Produk PTC Heater

Daya (W)	Tegangan	Referensi	Harga (Rp) (Sebelum PPN)	SS
Resistance Heater Aluminium (PTC Heater)				
55	110 ... 250 V AC	NSYCR55WU2	978.000	1
90	110 ... 250 V AC	NSYCR100WU2	1.388.000	2
150	110 ... 250 V AC	NSYCR150WU2	1.483.000	2
Resistance Heater Aluminium dengan Fan (PTC Heater)				
250	230 V AC	NSYCR250W230VV	4.410.000	2
400	230 V AC	NSYCR400W230VV	4.923.000	2
Resistance Heater Ber-insulasi Aluminium Body (Insulated PTC Heater)				
10	IP20 12 ... 24 V DC	NSYCR10WU1C	1.398.000	2
10	IP20 110 ... 250 V AC	NSYCR10WU2C	1.313.000	2
21	IP20 110 ... 250 V AC	NSYCR20WU2C	1.381.000	2
100	IP20 12 ... 24 V DC	NSYCR100WU2C	Hub kami	
147	IP20 110 ... 250 V AC	NSYCR150WU2C	Hub kami	
Resistance Heater dengan Fan Ber-insulasi (Insulated PTC Heater)				
177	230 V AC	NSYCR170W230VVC	4.608.000	2



Scan untuk
Data Pendukung



NSYCCOTH0



NSYCCOTH3C

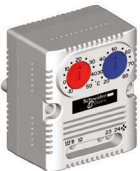

NSYCCOTH3D



NSYCCOTH3I



Produk Kontrol
Temperatur Elektronik

Sistem Kontrol Temperatur Panel

Data Teknis

- Mounting : DIN Rail, VDI cross Rai,
Mounting Plate, Spacial SF profile
- Indeks proteksi : IP 20
- Sensor Element : Bimetal / Elektronik
- Operating Temperatur : -40°C...+80°C (-4...+176°F)
- Bahan / Standard : Plastik abu abu / UL 94 V-0, UR

■ Panorama Produk Kontrol Temperatur & kelembaban

Sistem Sensor	Setting	Contact	Suplai Daya	Referensi	Harga (Rp) (Sebelum PPN)	SS
Kontrol Fan atau Alarm						
Bimetal	0 ... 60°C	NO		NSYCCOTH0	310.000	1
Kontrol Heater atau Alarm						
Bimetal	0 ... 60°C	NC		NSYCCOTH3C	362.000	1
Bimetal	32 ... 140°F	NC		NSYCCOTH3CF	362.000	2
Double Kontrol Fan dan Heater						
Bimetal	0 ... 60°C	NO&NC		NSYCCOTH3D	405.000	2
Bimetal	32 ... 140°F	NO&NC		NSYCCOTH3DF	558.000	2
Kontrol Fan atau Heater						
Bimetal	0 ... 60°C	NO&NC		NSYCCOTH3I	572.000	2
Kontrol Fan atau Heater - (Electronic Thermostat)						
Elektronik	-40...+80°C		9-30 VAC/DC	NSYCCOTH30VID	3.552.000	2
Kontrol Kelembaban (Elektronik Hygrostat)						
Elektronik			230 VAC	NSYCCOHE30VID	3.557.000	2

Catatan :

- Tempatkan kontrol temperatur di bagian atas panel untuk mendapatkan hasil yang maksimal.
- Tempatkan kontrol kelembaban di bagian bawah panel untuk mendapatkan hasil yang maksimal.
- Gunakan tabel di bawah untuk pedoman penentuan temperatur di dalam panel agar terhindar dari kondensasi.

Ambient Temperature (°C)		20	25	30	35	40	45	50	55
Kelembaban relatif (%)	40	6	11	15	19	24	28	33	37
	50	9	14	19	23	28	32	37	41
	60	23	17	21	26	31	36	40	45
	70	25	19	24	29	34	38	43	48
	80	26	21	26	31	36	41	46	51
	90	28	23	28	33	38	43	48	53
	100	20	25	30	35	40	45	50	55



Scan untuk
Data Pendukung



NSYTRR●●
Spring Type
Cepat & mudah



NSYTRV●●
Screw Type
Aplikasi terlengkap



NSYTRP●●
Push-in Type.
Cepat dan inovative

50%

lebih cepat
dibandingkan
Type Screw

Prinsip Koneksi



Tipe Koneksi
Pegas /Spring



Tipe Koneksi
Sekrup /Screw



Tipe Koneksi
Tekan /Push-in

Lineryg TR

Terminal Blok & Aksesori Kabel

■ The complete range of Lineryg TR, DIN Rail Terminal blocks brings simplicity of use in your installation

Spesifikasi	Technology	Spring	Screw	Push-In
	Type	NSYTRR●●	NSYTRV●●	NSYTRP●●
Component Materials	Insulating case	Polyamide 6.6		
	Connector and screw	High grade copper alloys		
	Commoning link	High grade copper alloys		
	Sprint element	Chromium-nickel spring steel		

Electrical and thermal characteristics of insulating case (polyamide 6.6)

Dielectric strenght	Conforming to VDE 0303-T21 & IEC 60243-1	kV/mm	80/65
Dielectric loss Tan coefficient at MHz	Conforming to VDE 0303-T4 & IEC 60250		0.01
Dielectric constant at 1 Mhz			3.7
Resistivity	Conforming to VDE 0303-T30 & IEC 60093	Ω.cm	10 ¹²
Surface resistance	Conforming to VDE 0303-T30 & IEC 60093	Ω	10 ¹²
Creep resistance	Conforming to VDE 0303-T30 & IEC 60093	CTI (kV)	500 (>400)
Ambient air temperature around the device	Conforming to VDE 0304-T21 & IEC 60216-1	°C	Operation: -40...+130
Inflammability clas	Conforming to UL 94	Class/mm thickness	V-0/0.8

Mounting rail characteristics

Mounting rail type						
Dimensions (Width x depth x thickness)	mm	35x7.5x1	35x15x1.5	35x15x1	35x15x1.5	35x16x1.8
Material		Steel	Steel	Steel	Steel	Steel
Equivalent c.s.a. in copper	mm ²	16	25	25	35	70
Short-circuit current withstand	kA	1.92	3	3	4.2	8.4

■ Ukuran & Arus Max

ISO metric size mm2	Size AWG	Size kcmill	Diameter mm	Current A
0.5	20	-	1.02	-
0.75	18	-	1.26	-
1	-	-	-	15
1.5	16	-	2.6	19.5
2.5	14	-	2.08	26
4	12	-	2.7	35
6	10	-	3.09	46
10	8	-	3.36	63
16	6	-	4.32	89
25	4	-	5.73	112
35	2	-	7.26	138
50	(1/0)0	-	12.08	168
70	(2/0)00	-	13.54	213
95	(3/0)000	-	15.33	258
-	(4/0)0000	-	17.22	-
120	-	250	19.01	299
150	-	300	20.48	344
185	-	350	22.05	392
240	-	500	26.57	461
300	-	600	30.03	500

Lineryg TR

Terminal Blok & Aksesori Kabel

■ The complete range of Lineryg TR, DIN rail Terminal blocks brings simplicity of use in your installation

	Passthrough	Protective Earth	Double Deck	Disconnect	Miniature	For neutral conductors	Measuring	High Current
Screw Type NSYTRV●●								
Spring Type NSYTRR●●								
Push-in Type NSYTRP●●								

■ Tipe Kemasan Cable End

- 1 Untaian 10 kantong :
c.s.a. 0.25 mm² to 4 mm² inclusive.
- 2 Individual kantong (isi 20 atau 100)
c.s.a. 6 mm² to 50 mm².
- 3 Dispenser pack (isi 200, 100 atau 50 unit)
0.5 to 2.5 mm² (single conductor cable)
2 x 0.7 to 2 x 2.5 mm² (twin conductors).



Dispenser Pack

■ Tersedia Aksesori

- 1 End stop Clip-on 5.2 mm (NSYTRAABB35)
- 2 End stop Screw 9.5 mm (NSYTRAABV35)
- 3 End plate width 2.2 (NSYTRAC●●)
- 4 Partition plate width 2 mm (NSYTRAP●●)
- 5 Plug-in bridge (NSYTRAL●●)
- 6 Step-down bridge, down to 2.5/4mm²
- 7 Vertical bridge
- 8 Pick-off terminal
- 9 Test plug (NSYTRAATM1)
- 10 Test adaptor (NSYTRAFT)
- 11 Warning label (NSYTRACS●●)
- 12 Marker tag holder (NSYTRASB●●)
- 13 DIN rail 35 x 7.2 mm (NSYSR200BBD)
- 14 Marking accessories (see Catalog)



Scan untuk
Data Pendukung

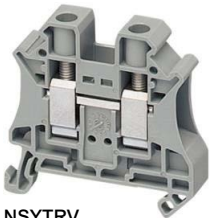

NSYTRV
Screw Terminal Blok



NSYTRAC
End Section



NSYTRAL
Konektor Plug-in



NSYTRAP
Konektor Plug-In



NSYTRACS
Tutup Pengaman

Lineryg TR

Terminal Blok

Tipe Sekrup (Screw)

■ Tipe Sekrup (Screw)

Ukuran (mm)	Deskripsi	Referensi	Harga (Rp) (Sebelum PPN)	SS
2.5	Terminal blok warna abu-abu	NSYTRV22	18.000	1
	End section	NSYTRAC22	10.000	1
	Partisi	NSYTRAP22	13.000	1
	20 Kutub Konektor Plug-in, 2,5mm ² TB	NSYTRAL220	122.000	2
	2 Kutub Konektor Plug-in, 2,5mm ² TB	NSYTRAL22	9.800	2
	Tutup pengaman terminal, 2,5mm ² TB	NSYTRACS2	21.000	2
4	Terminal blok warna abu-abu	NSYTRV42	20.000	1
	End section	NSYTRAC22	10.000	1
	Partisi	NSYTRAP22	13.000	1
	20 kutub Konektor Plug-in, 4mm ² TB	NSYTRAL420	123.000	2
	2 kutub Konektor Plug-in, 4mm ² TB	NSYTRAL42	8.000	2
	Tutup pengaman terminal, 4mm ² TB	NSYTRACS4	26.000	2
6	Terminal blok warna abu-abu	NSYTRV62	28.000	1
	End section	NSYTRAC22	10.000	1
	Partisi	NSYTRAP22	13.000	1
	10 kutub Konektor Plug-in, 6mm ² TB	NSYTRAL610	92.000	2
	2 kutub Konektor Plug-in, 6mm ² TB	NSYTRAL62	20.000	2
	Tutup pengaman terminal, 6mm ² TB	NSYTRACS6	32.000	2
10	Terminal blok warna abu-abu	NSYTRV102	40.000	1
	End section	NSYTRAC22	10.000	1
	Partisi	NSYTRAP22	13.000	1
	2 kutub Konektor Plug-in, 10mm ² TB	NSYTRAL102	25.000	2
	Tutup pengaman terminal, 10mm ² TB	NSYTRACS10	38.000	2
	Terminal blok warna abu-abu	NSYTRV162	50.000	1
16	End section	NSYTRAC162	14.000	2
	2 kutub Konektor Plug-in, 16mm ²	NSYTRAL162	30.000	2
	Tutup pengaman terminal, 16mm ²	NSYTRACS16	40.000	2
	Terminal blok warna abu-abu, 35mm ²	NSYTRV352	109.000	1
	2 kutub Konektor Plug-in, 35mm ²	NSYTRAL352	55.000	2
	Tutup pengaman terminal, 35mm ²	NSYTRACS35	50.000	2
70	Terminal blok warna abu-abu, 70mm ²	NSYTRV702	645.000	2
	2 kutub Konektor Plug-in, 70mm ²	NSYTRAL702	186.000	2

Tersedia pilihan warna : Abu Abu, Biru, Orange, Merah, Hijau, Putih, Hitam, Coklat, Kuning Silakan lihat katalog produk kami

■ Contoh Tipe Sekrup / Screw

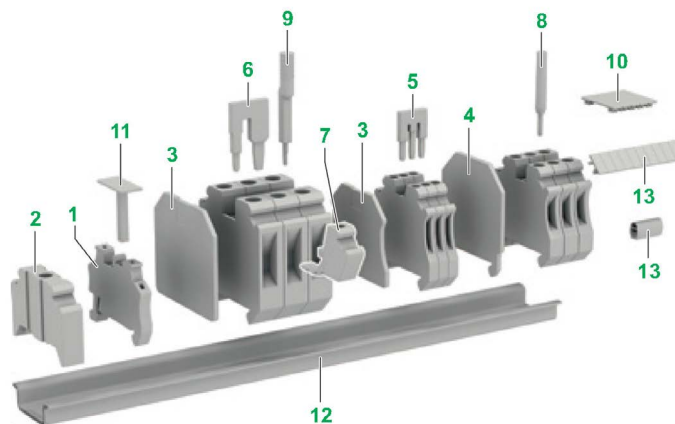



NSYTRV●●PE
Screw Terminal Blok



QR Code
Mounting Rails



NSYDPR●●



NSYSDR●●



NSYTRAAB35



NSYTRAABV35



NSYTRAB●●



QR Code
Label Marker

Linergy TR

Terminal Blok

Tipe Earth & Aksesori (Rel Simetris & Label)

■ Tipe Earth (untuk konduktor pembumian)

Ukuran (mm)	Deskripsi	Referensi	Harga (Rp) (Sebelum PPN)	SS
2	Terminal blok warna hijau / kuning	NSYTRV22PE	57.000	2
4	Terminal blok warna hijau / kuning	NSYTRV42PE	57.000	1
6	Terminal blok warna hijau / kuning	NSYTRV62PE	75.000	2
10	Terminal blok warna hijau / kuning	NSYTRV102PE	101.000	2
16	Terminal blok warna hijau / kuning	NSYTRV162PE	128.000	2
35	Terminal blok warna hijau / kuning	NSYTRV352PE	179.000	2

■ Rel Simetris

Referensi	Tipe Rel	Ukuran (mm)			Harga (Rp) (Sebelum PPN)	SS
		Lebar	Tinggi	Panjang		
NSYDPR200	Simetris polos *	35	15	2000	425.000	2
NSYDPR200D	Simetris berlubang *	35	15	2000	730.000	2
NSYDPR200T	Simetris berlubang **	35	15	2000	246.000	2
NSYSDR200B	Simetris polos profil topi **	35	7.2	2000	137.000	2
NSYSDR200BD	Simetris berlubang profil topi **	35	7.2	2000	170.000	2

*) Ketebalan 1.5 mm

**) Ketebalan 1 mm

■ Aksesori

Referensi	Keterangan	Harga (Rp) (Sebelum PPN)	SS
NSYTRAAB35	Clip-on End bracket (NSYTR 5.2mm for DIN Rail 35mm)	16.000	1
NSYTRAABV35	Screw End bracket (NSYTR 9.5mm for DIN Rail 35mm)	22.000	2

Label 10 angka berurutan (1...10, 11...20,)

NSYTRAB510	lebar = 5 mm (Angka 1...10)	18.000	2
NSYTRAB520	lebar = 5 mm (Angka 11...20)	18.000	2
NSYTRAB530	lebar = 5 mm (Angka 21...30)	18.000	2
NSYTRAB540	lebar = 5 mm (Angka 31...40)	18.000	2
NSYTRAB550	lebar = 5 mm (Angka 41...50)	18.000	2
NSYTRAB560	lebar = 5 mm (Angka 51...60)	18.000	2
NSYTRAB750	lebar = 5 mm (Angka 61...70)	18.000	2
NSYTRAB580	lebar = 5 mm (Angka 71...80)	18.000	2
NSYTRAB590	lebar = 5 mm (Angka 81...90)	18.000	2
NSYTRAB5100	lebar = 5 mm (Angka 91...100)	18.000	2
NSYTRAB610	lebar = 6 mm (Angka 1...10)	18.000	2
NSYTRAB810	lebar = 8 mm (Angka 1...10)	22.000	2

Catatan : Untuk kebutuhan produk terminal block lainnya (tipe lug-lug ataupun tipe lug-clamp), silakan hubungi kami.



Scan untuk
Data Pendukung



Scan untuk
Data Pendukung

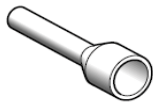

Non Markable

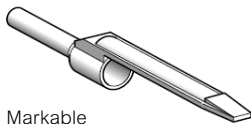

Markable

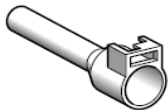

Clip In Marker
Tag Holder

Linergy TR

Cable End

Single Conductor (Standard NF C 63-023)

■ Tipe Non Markable

Ukuran Kabel (mm)	Warna	Referensi	Harga (Rp) (Sebelum PPN)	SS	Min Order Lot
0.25	Kuning	DZ5CE002	3.200	2	100
0.34	Hijau	DZ5CE003	3.200	2	100
0.5	Putih	DZ5CE005	3.200	1	100
0.75	Biru	DZ5CE007	3.200	1	100
1	Merah	DZ5CE010	3.200	2	100
1.5	Hitam	DZ5CE015	3.200	1	100
2	Kuning	DZ5CE020	3.200	2	100
2.5	Abu-abu	DZ5CE025	3.200	1	100
4	Oranye	DZ5CE042	3.200	2	100
6	Hijau	DZ5CE062	5.500	2	100

■ Tipe Markable

Ukuran Kabel (mm)	Warna	Referensi	Harga (Rp) (Sebelum PPN)	SS	Min Order Lot
0.25	Kuning	DZ5CA002	4.500	2	100
0.34	Hijau	DZ5CA003	4.500	2	100
0.5	Putih	DZ5CA005	4.500	2	100
0.75	Biru	DZ5CA007	4.500	2	100
1	Merah	DZ5CA010	4.500	2	100
1.5	Hitam	DZ5CA015	4.500	2	100
2.5	Abu-abu	DZ5CA025	4.500	2	100

■ Tipe Clip in Marker Tag Holder

Ukuran Kabel (mm)	Warna	Referensi	Harga (Rp) (Sebelum PPN)	SS	Min Order Lot
4	Oranye	DZ5CA042	9.000	2	100
6	Hijau	DZ5CA062	9.000	2	100
10	Coklat	DZ5CA102	9.000	1	100
16	Putih	DZ5CA162	9.000	2	100
25	Hitam	DZ5CA253	13.000	1	100
35	Merah	DZ5CA352	32.000	1	20
50	Biru	DZ5CA502	38.000	2	20

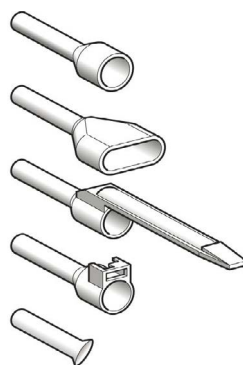

- Single conductor cable ends with insulating bezel
- Twin Conductor cable ends with insulating bezel
- Single Conductor cable ends with "markable" insulating bezel
- Single Conductor cable ends with Insulating bezel for fitting clip-on marker tags
- Single Conductor cable ends without insulating bezel



Life Is On

Schneider
Electric

Sinyal & Kontrol

Easy Harmony XA2 (diameter 22 mm)	14-4
Modular Push Button	14-4
Monolitik Pilot Lamp & Indikator	14-5
Easy Harmony XB2 (diameter 22 mm)	14-6
Overview	14-6
Karakteristik	14-7
Modular Push Button berbahan metal	14-8
Tipe XB4 Metal dan XB5 Plastik (Overview)	14-9
Harmony XB4 (diameter 22 mm modular tipe metal)	14-10
Push Button	14-10
Selector Switch, Emergency Stop, dan Key Switch	14-10
Aksesori (kontak tambahan)	14-10
Pilot Lamp	14-11
Tombol Iluminasi	14-12
Selector Iluminasi	14-12
Potensiometer	14-12
Harmony XB4 Sertifikasi ATEX Untuk <i>Explosive atmosphere</i>	14-13
Push Button Untuk Explosive atmosphere, Sertifikasi ATEX	14-13
Tombol Iluminasi Untuk Explosive atmosphere, Sertifikasi ATEX	14-13
Selector Switch, Emergency Stop, dan Key Switch Sertifikasi ATEX	14-13
Pilot Lamp Untuk Explosive atmosphere, Sertifikasi ATEX	14-14
Push to Test Pilot Lamp Untuk Explosive atmosphere, Sertifikasi ATEX	14-14
Kontak Blok Untuk Explosive atmosphere, Sertifikasi ATEX	14-14
Light Block Untuk Explosive atmosphere, Sertifikasi ATEX	14-14
Harmony XB5 (diameter 22 mm modular tipe plastik)	14-15
Push Button dan <i>Wireless</i> Push Button	14-15
Selector Switch, Emergency Stop, dan Key Switch	14-15
Pilot Lamp	14-16
Tombol Iluminasi	14-17
Selector Iluminasi	14-17
Potensiometer	14-17
Aksesori (Kontak Tambahan)	14-18
USB dan RJ45 Panel Mounted	14-18
Harmony XB5 (diameter 30 mm modular tipe plastik dan rata panel)	14-19
Push Button Rata Panel Tanpa marking	14-19
Selector Switch Rata Panel dan Key Switch	14-19
Buzzer/Annunciator (IP 66, IP 67, and IP 69) Diameter 22mm	14-19
Pilot Lamp Rata Panel	14-20
Tombol Iluminasi Rata Panel	14-20
Selector Switch Iluminasi Rata Panel	14-20
Harmony XB7 (diameter 22 mm monolitik)	14-21

Sinyal & Kontrol

Cam Switch Saklar Kendali dan Daya IP 40	14-22
Saklar OFF - ON	14-22
Saklar Alih	14-22
Panel Kendali	14-23
Panel Kendali XAL Tipe Plastik	14-23
Panel Kendali Terpasang	14-23
Panel Kendali Kosong (Plastik)	14-23
Blok Kontak	14-23
Panel Kendali XAP Tipe Metal	14-24
Panel Kendali Kosong (Metal)	14-24
Tower Light	14-25
Tipe XVM Diameter 45 mm	14-25
Tipe XVG Diameter 60 mm	14-25
Foot Switch & Pendant	14-26
Foot Switch EXP	14-26
Pendant/Crane Controller	14-26

Easy Harmony XA2

Diameter 22 mm Modular Push Button



Scan untuk
Data Teknis



XA2EA31



XA2EW34M1



XA2ED●●



XA2ES542



ZA2EE10●

■ Push Button, IP54

Tipe	Kontak	Warna	Referensi	Harga (Rp) (Sebelum PPN)	SS
Flush	1 N/O	Hitam	XA2EA21	45.000	1
		Hijau	XA2EA31	45.000	1
		Kuning	XA2EA51	45.000	1
		Biru	XA2EA61	45.000	2
		Putih	XA2EA11	45.000	2
		Merah	XA2EA42	45.000	1
Tombol Iluminasi 220V AC	1 N/O	Hijau	XA2EW33M1	126.500	1
		Merah	XA2EW34M1	126.500	1
		Kuning	XA2EW35M1	126.500	2
		Putih	XA2EW31M1	126.500	2
		Biru	XA2EW36M1	126.500	2
		Merah	XA2EW34M2	126.500	1

Pada Tombol Iluminasi:

Untuk 24VDC/AC gantikan **M1** dengan **B1** dan **M2** dengan **B2**

Untuk 380 sd 400 VAC Gantikan **M1** dengan **Q1** dan **M2** dengan **Q2**

■ Selector Switch dan Emergency Stop, IP54

Tipe	Tegangan	Warna	Referensi	Harga (Rp) (Sebelum PPN)	SS
Selector					
2 posisi stay put	1 N/O	Hitam	XA2ED21	60.500	1
3 posisi stay put	2 N/O	Hitam	XA2ED33	83.500	1
Emergency Stop					
Push Pull Ø40 mm	1 N/C	Merah	XA2ET42	126.500	2
Turn to release Ø40 mm	1 N/C	Merah	XA2ES542	82.400	1

■ Aksesori (Kontak Tambahan)

Tipe	Referensi	Harga (Rp) (Sebelum PPN)	SS
Kontak 1 N/O**	ZA2EE101	39.100	1
Kontak 1 N/C**	ZA2EE102	39.100	1

Catatan : Penambahan kontak ** pada push button maksimum 6 kontak.

Easy Harmony XA2

Diameter 22 mm Monolitik Pilot Lamp & Indikator



XA2EVM4LC



XA2EVM3LC



XA2EVM5LC



XA2EVB34LC



XA2EVM34SPC



XA2EVM34BPC



XA2EVM34GPC

Pilot Lamp, IP65

Tipe	Tegangan	Warna	Referensi	Harga (Rp) (Sebelum PPN)	SS
Monolitik, Integral LED	24V AC/DC	Putih	XA2EVB1LC	37.500	2
		Hijau	XA2EVB3LC	37.500	1
		Merah	XA2EVB4LC	37.500	1
		Jingga	XA2EVB5LC	37.500	2
		Biru	XA2EVB6LC	37.500	2
		Kuning	XA2EVB8LC	37.500	2
Monolitik, Integral LED	110V AC/DC	Putih	XA2EVF1LC	48.700	2
		Hijau	XA2EVF3LC	48.700	1
		Merah	XA2EVF4LC	48.700	2
		Jingga	XA2EVF5LC	48.700	2
		Biru	XA2EVF6LC	48.700	2
		Kuning	XA2EVF8LC	48.700	2
Monolitik, Integral LED	220V AC	Putih	XA2EVM1LC	35.900	1
		Hijau	XA2EVM3LC	35.900	1
		Merah	XA2EVM4LC	35.900	1
		Jingga	XA2EVM5LC	35.900	1
		Biru	XA2EVM6LC	35.900	1
		Kuning	XA2EVM8LC	35.900	1

- Tersedia juga dalam tegangan 12V AC/DC, 30V AC/DC, 48V AC/DC, 63.5V AC/DC, 220V DC, 380V AC
- Dengan cara mengganti huruf setelah **XA2E** dengan kode huruf sebagai berikut:

Tegangan Koil	12 VAC/DC	30 VAC/DC	48 VAC/DC	63.5 VAC/DC	220 VDC	380 VAC
Kode Referensi	VJ	VC	VE	VEE	VMD	VQ

- Harga bisa saja berbeda untuk masing-masing tipe tegangan koil
- Silakan hubungi customer care kami untuk informasi lebih lanjut

Pilot Lamp Bi-Color, IP65

Tipe	Tegangan	Warna	Referensi	Harga (Rp) (Sebelum PPN)
Monolitik, Bi-Color	24V AC/DC	Merah/Hijau	XA2EVB34LC	Hub Kami
	220 V AC	Merah/Hijau	XA2EVM34LC	Hub Kami

Indikator

Tegangan	Warna	Tipe Indikator	Referensi	Harga (Rp) (Sebelum PPN)
220...230 V AC	Hijau/Merah	Isolation Switch	XA2EVM34SPC	Hub Kami
		Circuit Breaker	XA2EVM34BPC	Hub Kami
		Ground	XA2EVM34GPC	Hub Kami

- Tersedia juga dalam tegangan **110V AC** (dengan mengganti kode VM dengan VF) dan **380V AC** (dengan mengganti kode VM dengan VQ)
- Harga sama dengan Indikator tegangan 220...230V AC

Easy Harmony XB2

Overview

Easy Harmony XB2 merupakan varian produk push button modular yang berbahan metal



Didesain untuk memenuhi berbagai kebutuhan industri, tersedia dalam bentuk rangkaian produk lengkap ataupun secara terpisah per komponen.



Perbandingan fitur antara XB2 dengan XA2

Fitur	XB2	XA2
A (Head)	 <ul style="list-style-type: none"> • Height: 12mm • Metal 	 <ul style="list-style-type: none"> • Height: 12mm • Plastic
B (Fixing collar)	<ul style="list-style-type: none"> • 2 fixing screws • foot print of the screw adapted 	Clip on mounting
C (Contact block)	<ul style="list-style-type: none"> • 2 CB per level, maximum 6 CBs • Height: 24 mm • Fixed by screw 	<ul style="list-style-type: none"> • 2 CB per level, maximum 6 CBs • Height: 24 mm • Fixed by screw
Illuminated function	<ul style="list-style-type: none"> • BA9s pilot light block • service life: 50K hours 	<ul style="list-style-type: none"> • BA9s pilot light block • service life: 10K hours

Easy Harmony XB2

Karakteristik

Desain modular ini memudahkan pengguna dalam proses pemasangan maupun penggantian komponen. Adapun **keunggulan** dari **Easy Harmony XB2**, selain terbuat dari bahan metal adalah sebagai berikut:

■ Performa yang unggul

Robustness

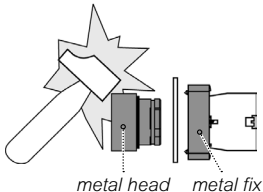

3.000.000
Mechanical durability

metal head metal fix collar

Convenient

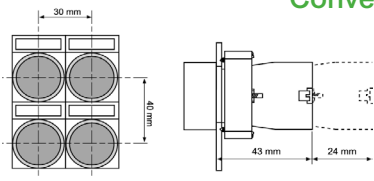

Compact size Contact block stack

Safety

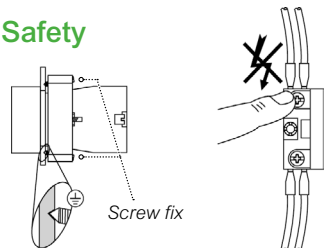

- ground protection
- anti-electric-shock

Screw fix

High Performance



IP65
High protection

1.000.000
Electrical reliability

■ Pemasangan mudah

Easy Harmony XB2 dapat diinstal dan dilepas dengan mudah



- ✓ Masukkan kepala (head) dan putar ke arah bagian komponen badan (body)
- ✓ Pemasangan menggunakan screw ganda
- ✓ Sistem anti-kendor pada screw clamp terminal pada contact block



■ Ramah Lingkungan

- Tsertifikasi dan memenuhi segala persyaratan yang ada di semua benua: EN/IEC, CÉ, CCC
- Perlindungan terhadap objek padat, debu, dan air: IP65, IP66 (boot push button), IP40 (buzzer)
- Standar Internasional: IEC 60947-5-1, IEC 60947-5-5, EN 60947-5-1, EN 60947-5-5, GB/T 14048.1, GB/T 14048.5, GB/T 14048.14
- Suhu operasional mulai dari -25°C hingga +70°C / -13°F hingga 158°F pada aplikasi di luar ruangan
- Memiliki vibration resistance yang tinggi dengan shock-proof connection screws (dengan pengencangan ulang secara berkala)



XB2BA31C



XB2BA42C



XB2BW33B1C



XB2BW35M1C



XB2BS542C



XB2BD25C



XD2PA12CR

Easy Harmony XB2

Diameter 22 mm Modular Push Button

■ Modular Push Button, IP65 berbahan metal

Tipe	Kontak	Warna	Referensi	Harga (Rp) (Sebelum PPN)	SS
Flush, Spring return	1 N/O	Hitam	XB2BA21C	71.700	2
		Hijau	XB2BA31C	71.700	2
	1 N/C	Kuning	XB2BA51C	71.700	2
		Biru	XB2BA61C	71.700	2
		Putih	XB2BA11C	71.700	2
		Merah	XB2BA42C	71.700	2

■ Illuminated Modular Push Button, IP65 berbahan metal

Tipe	Kontak	Warna	Referensi	Harga (Rp) (Sebelum PPN)	SS
Tombol Iluminasi 24V DC	1 N/O	Hijau	XB2BW33B1C	158.000	2
		Jingga	XB2BW35B1C	158.000	2
		Biru	XB2BW36B1C	158.000	2
		Putih	XB2BW31B1C	158.000	2
		Merah	XB2BW34B1C	158.000	2
Tombol Iluminasi 220V AC	1 N/O	Hijau	XB2BW33M1C	173.500	2
		Jingga	XB2BW35M1C	173.500	2
		Biru	XB2BW36M1C	173.500	2
		Putih	XB2BW31M1C	173.500	2
		Merah	XB2BW34M1C	173.500	2

■ Emergency Stop

Tipe	Kontak	Diameter (mm)	Referensi	Harga (Rp) (Sebelum PPN)	SS
Turn to release, warna merah	1 N/C	30	XB2BS442C	121.500	2
		40	XB2BS542C	127.500	2
		60	XB2BS642C	130.500	2

■ Selector Switch

Tipe	Kontak	Posisi	Referensi	Harga (Rp) (Sebelum PPN)	SS
Handle standar, warna hitam	1 NO	2-stay put	XB2BD21C	91.500	2
	1 NO + 1 NC	2-stay put	XB2BD25C	119.000	2
	1 NO	2-spring return	XB2BD41C	91.500	2
	1 NO + 1 NC	2-spring return	XB2BD45C	119.000	2
	2 NO	3-stay put	XB2BD33C	119.000	2
	2 NO	3-spring return dari 2 arah	XB2BD53C	119.000	2
	2 NO	3-spring return dari 1 arah	XB2BD73C	119.000	2

■ Joystick Controller

Deskripsi	Posisi Operasi	Spring Return	Referensi	Harga (Rp) (Sebelum PPN)	SS
Handle standar, warna hitam	1 notch	✗	XD2PA12CR	246.500	2
	1 NO tiap arah	✓	XD2PA22CR	249.500	2
	1 notch	✗	XA2PA14CR	328.500	2
	1 NO tiap arah	✓	XA2PA24CR	502.500	2

Tipe XB4 Metal dan XB5 Plastik

Push Button dengan proteksi terhadap debu & air terbaik di dunia



Scan QR untuk
Pilih Push Button
Sesuai Kebutuhan

IP69

Robust performance
even in hars
environments.

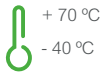

Temukan banyak pilihan tombol, sakelar & lampu pilot untuk memenuhi sebagian besar aplikasi industri.

Tersedia dalam versi logam dan plastik. Jajaran Harmony sesuai dengan kebutuhan Anda untuk ketahanan, keamanan, dan kemudahan pemasangan.

- **XB4** dan **XB5** didesain dengan performance handal bahkan di kondisi ekstrem
- Efektifitas sealing sampai dengan IP66, IP67, IP68, IP69, IP69K dan type 4X
- Impact Resistance sampai IK06
- Standards IEC, UL, CCC EAC JIS
- Sesuai Aplikasi Marine dengan Standard BV LROS BDNV dan GL



Push Button didesain untuk **10 juta kali tekan**. Setara dengan operasi setiap hari selama 27 Tahun!

Button Modular dengan pilihan body kontak dan kepala sesuai kebutuhan

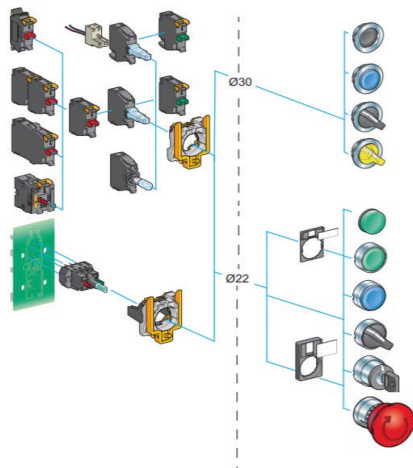

Tersedia pilihan 22mm standard dan 30mm rata panel

ZB4BA3



Standard mounting



ZB4FA3



Flush mounting

Kini tersedia!

Emergency Stop Button dengan Illuminated Ring



Tersedia varian button paling lengkap

selain Aplikasi standard juga tersedia Soket USB, RJ45, Buzzer, Potensiometer, Test Button, dll.

Mounting 22mm Standar



Mounting 30mm Rata Panel



Wireless Push Button





XBABA31



XBABP51



XB4BL73415



XB4BD33



XB4BS8442



XB4BG33



ZBE101

Harmony XB4

Diameter 22 mm Modular Tipe Metal

■ Push Button

Tipe	Kontak	Warna	Complete Set		
			Referensi	Harga (Rp) (Sebelum PPN)	SS
Flush	1 N/O	Hitam	XB4BA21	147.500	2
		Hijau	XB4BA31	147.500	2
		Kuning	XB4BA51	147.500	2
		Biru	XB4BA61	147.500	2
	1 N/C	Merah	XB4BA42	147.500	2
Flush ("I" white Marking)	1 N/O	Hijau	XB4BA3311	198.000	2
Flush ("O" white Marking)	1 N/C	Merah	XB4BA4322	173.500	2
Booted (IP 66)	1 N/O	Hitam	XB4BP21	193.500	2
		Hijau	XB4BP31	193.500	2
		Kuning	XB4BP51	193.500	2
		Biru	XB4BP61	214.500	2
	1 N/C	Merah	XB4BP42	193.500	2
Double Headed	1 N/O + 1 N/C	Hijau Merah	XB4BL73415	322.000	1

■ Selector Switch, Emergency Stop, dan Key Switch

Tipe	Kontak	Warna	Complete Set		
			Referensi	Harga (Rp) (Sebelum PPN)	SS
Selector					
2 posisi stay put	1 N/O	Hitam	XB4BD21	204.500	2
2 posisi spring return		Hitam	XB4BD41	224.000	2
3 posisi stay put	2 N/O	Hitam	XB4BD33	235.500	2
3 posisi spring return di kiri dan di kanan		Hitam	XB4BD53	242.000	2
Emergency Stop / Mushroom					
spring return Ø40 mm	1 N/C	Merah	XB4BC42	235.500	2
latching Ø40 mm		Merah	XB4BT842	325.500	2
latching turn to release Ø40 mm		Merah	XB4BS8442	262.000	2
latching key release Ø40 mm		Merah	XB4BS9442	310.000	2
Key Switch					
2 pos stay put cabut kunci di kiri	1 N/O	Hitam	XB4BG21	444.000	2
2 pos stay put cabut kunci di kiri & kanan		Hitam	XB4BG41	444.000	2
2 pos spring return cabut kunci di kiri	2 N/O	Hitam	XB4BG61	479.000	2
3 pos stay put cabut kunci di tengah		Hitam	XB4BG33	528.500	2

■ Aksesori (kontak tambahan)

Tipe	Referensi	Harga (Rp) (Sebelum PPN)	SS
Badan dengan kontak 1 N/O	ZB4BZ101	87.500	1
Badan dengan kontak 1 N/C	ZB4BZ102	87.500	1
Badan dengan kontak 2 N/O	ZB4BZ103	117.500	2
Badan dengan kontak 2 N/C	ZB4BZ104	117.500	2
Badan dengan kontak 1 N/O + 1 N/C	ZB4BZ105	117.500	1
Kontak 1 N/O**	ZBE101	43.800	1
Kontak 1 N/C**	ZBE102	43.800	1

Catatan : Penambahan kontak ** pada tombol tekan maksimum 9 kontak

Harmony XB4

Diameter 22 mm Modular Tipe Metal



XB4BVB4



XB4BVB3



XB4BVB5

■ Pilot Lamp

Tipe	Tegangan	Warna	Complete Set			
			Referensi	Harga (Rp) <i>(Sebelum PPN)</i>	SS	
Protected LED	24 V AC/DC	Putih	XB4BVB1	233.000	2	
		Hijau	XB4BVB3	233.000	2	
		Merah	XB4BVB4	233.000	2	
		Jingga	XB4BVB5	233.000	2	
		Biru	XB4BVB6	233.000	2	
		Putih	XB4BVG1	317.000	2	
	110 ... 120 V AC	Hijau	XB4BVG3	317.000	2	
		Merah	XB4BVG4	317.000	2	
		Jingga	XB4BVG5	317.000	2	
		Biru	XB4BVG6	317.000	2	
		230 ... 240 V AC	Putih	XB4BVM1	171.500	2
			Hijau	XB4BVM3	171.500	2
Merah	XB4BVM4		171.500	2		
Jingga	XB4BVM5		171.500	2		
Biru	XB4BVM6		171.500	2		
Putih	XB4BV31		Hub Kami			
Dengan Trafo	110 ... 120 V AC	Hijau	XB4BV33	422.000	2	
		Merah	XB4BV34	422.000	2	
		Jingga	XB4BV35	422.000	2	
	230 V AC	Putih	XB4BV41	422.000	2	
		Hijau	XB4BV43	422.000	2	
		Merah	XB4BV44	422.000	2	
		Jingga	XB4BV45	422.000	2	



XB4BW34B5



XB4BW35B5



XB4BW33B5



XB4BK123B5



XB4BD912R1K

Harmony XB4

Diameter 22 mm Modular Tipe Metal

■ Push Button Iluminasi

Tipe	Tegangan	Kontak	Warna	Complete Set					
				Referensi	Harga (Rp) (Sebelum PPN)	SS			
	24 V AC/DC	1 N/O + 1 N/C	Putih	XB4BW31B5	377.000	2			
			Hijau	XB4BW33B5	377.000	2			
			Merah	XB4BW34B5	377.000	2			
			Jingga	XB4BW35B5	377.000	2			
			Biru	XB4BW36B5	377.000	1			
			Protected LED Termasuk lampu protected LED	110 ... 120 V AC	1 N/O + 1N/C	Putih	XB4BW31G5	381.500	2
						Hijau	XB4BW33G5	381.500	2
						Merah	XB4BW34G5	381.500	2
						Jingga	XB4BW35G5	381.500	2
				230 ... 240 V AC	1 N/O + 1N/C	Putih	XB4BW31M5	354.000	2
Hijau	XB4BW33M5	354.000				2			
Merah	XB4BW34M5	354.000				2			
Jingga	XB4BW35M5	354.000				2			
Biru	XB4BW36M5	354.000				2			
Dengan Trafo termasuk bola lampu tipe BA9s, 6V	110 ... 120 V AC	1 N/O + 1N/C				Hijau	XB4BW3335	517.500	2
			Merah	XB4BW3435	517.500	2			
			Hijau	XB4BW3345	512.500	2			
Protected LED Double Headed IP 66	24 V AC/DC	1 N/O + 1N/C	Hj.M	XB4BW73731B5	471.500	2			
			230 ... 240 V AC	1 N/O + 1N/C	Hj.M	XB4BW73731M5	477.000	2	

■ Selektor Iluminasi

Tipe	Tegangan	Kontak	Warna	Complete Set					
				Referensi	Harga (Rp) (Sebelum PPN)	SS			
	24 V AC/DC	1 N/O + 1N/C	Hijau	XB4BK123B5	536.000	2			
			Merah	XB4BK124B5	536.000	2			
			Jingga	XB4BK125B5	536.000	2			
			Protected LED 2 position stay put	110 ... 120 V AC	1 N/O + 1N/C	Hijau	XB4BK123G5	536.000	2
						Jingga	XB4BK125G5	536.000	2
						Hijau	XB4BK123M5	536.000	2
	230 ... 240 V AC	1 N/O + 1N/C	Merah	XB4BK124M5	536.000	2			
			Jingga	XB4BK125M5	536.000	2			

■ Potensiometer

Tipe	Tegangan	Resistensi	Complete Set		
			Referensi	Harga (Rp) (Sebelum PPN)	SS
Potensiometer R1K	Max 30VAC/42VDC	1 K Ohm	XB4BD912R1K	1.673.500	2
Potensiometer R10K	Max 30VAC/42VDC	10 K Ohm	XB4BD912R10K	1.673.500	2
Potensiomete R100K	Max 30VAC/42VDC	100 K Ohm	XB4BD912R100K	1.673.500	2
Potensiometer R4K7	Max 30VAC/42VDC	4700 Ohm	XB4BD912R4K7	1.673.500	2
Potensiometer R47K	Max 30VAC/42VDC	47 K Ohm	XB4BD912R47K	1.673.500	2
Potensiometer R470K	Max 30VAC/42VDC	470 K Ohm	XB4BD912R470K	1.673.500	2

Terdiri dari Metal Body Diameter 22, Mounting dan Potensiometer



XB4BP482EX



XB4BP383B5EX



XB4BD33EX

Harmony XB4 Varian ATEX

Diameter 22 mm Modular Tipe Plastik, Untuk Explosive Atmosphere, Sertifikasi ATEX

■ Push Button Untuk Explosive Atmosphere, Sertifikasi ATEX

Tipe	Zona		Kontak	Warna	Referensi	Harga (Rp) (Sebelum PPN)	SS
	Dust	Gas					
Dengan Silicon bening	21-22		1 N/O	Hitam	XB4BP21EX	1.318.500	2
			1 N/O	Hijau	XB4BP31EX	1.322.000	2
Dengan Silicon Warna	21-22		1 N/O	Hitam	XB4BPS21EX	1.971.000	2
			1 N/O	Hijau	XB4BPS31EX	1.976.000	2
			1 N/O	Kuning	XB4BPS51EX	Hub Kami	2

■ Tombol Iluminasi Untuk Explosive Atmosphere, Sertifikasi ATEX

Tipe	Tegangan	Zona		Kontak	Warna	Referensi	Harga (Rp) (Sebelum PPN)	SS
		Dust	Gas					
Booted, clear silicon	24V AC/DC	21-22		1 N/O	Putih	XB4BP183B5EX	Hub Kami	
				1 N/O	Hijau	XB4BP383B5EX	2.483.000	2
				1 N/C	Merah	XB4BP483B5EX	2.270.000	2

■ Selector Switch, Emergency Stop, dan Key Switch Untuk Explosive Atmosphere, Sertifikasi ATEX

Tipe	Zona		Kontak	Warna	Referensi	Harga (Rp) (Sebelum PPN)	SS
	Dust	Gas					
Selector Standard Handle							
2 posisi stay put	21-22		1 N/O 1 N/C	Hitam	XB4BD25EX	1.479.000	2
3 posisi stay put			2 N/O	Hitam	XB4BD33EX	1.414.000	2
Emergency Stop / Mushroom							
Latching turn to release				Merah	XB4BS8445EX	4.600.500	2
Key Switch							
2 pos stay put cabut kunci di kiri			1 N/O	Hitam	XB4BG21EX	2.642.500	2



XB4BVBM3GEX



XB4BW21BM5GEX



ZBE101GEX



ZBVM1GEX

Harmony XB4 Varian ATEX

Diameter 22 mm Modular Tipe Plastik, Untuk Explosive Atmosphere, Sertifikasi ATEX

■ Pilot Lamp Untuk Explosive Atmosphere, Sertifikasi ATEX

Tipe	Tegangan	Zona		Warna	Referensi	Harga (Rp) (Sebelum PPN)	SS
		Dust	Gas				
Dengan protected LED	24...240V AC/ DC	21-22	1-2	Putih	XB4BVBM1GEX	2.600.500	2
				Hijau	XB4BVBM3GEX	2.597.000	2
				Merah	XB4BVBM4GEX	2.598.000	2
				Jingga	XB4BVBM5GEX	2.597.000	2
				Biru	XB4BVBM6GEX	2.600.500	2

■ Push to Test Pilot Lamp Untuk Explosive Atmosphere, Sertifikasi ATEX

Tipe	Tegangan	Zona		Warna	Referensi	Harga (Rp) (Sebelum PPN)	SS
		Dust	Gas				
Dengan protected LED	24...245V AC/ DC	21-22	1-2	Putih	XB4BW21BM5GEX	4.911.500	2
				Hijau	XB4BW23BM5GEX	4.908.000	2
				Merah	XB4BW24BM5GEX	4.902.000	2
				Jingga	XB4BW25BM5GEX	4.908.000	2
				Biru	XB4BW26BM5GEX	4.902.000	2

■ Kontak Blok Untuk Explosive Atmosphere, Sertifikasi ATEX

Tipe	Tegangan	Zona		Kontak	Referensi	Harga (Rp) (Sebelum PPN)	SS
		Dust	Gas				
Kontak Blok Single	21-22	1-2		1 N/O	ZBE101GEX	896.500	2
				1 N/C	ZBE102GEX	954.500	2

■ Light Block Untuk Explosive Atmosphere, Sertifikasi ATEX

Tipe	Tegangan	Zona		Warna	Referensi	Harga (Rp) (Sebelum PPN)	SS
		Dust	Gas				
Integral LED	24...254V AC/DC	21-22	1-2	Putih	ZBVM1GEX	1.825.500	2
				Hijau	ZBVM3GEX	1.825.500	2

Harmony XB5

Diameter 22 mm Modular Tipe Plastik



XB5AA31



XB5AP51



XB5RFA02



XB5AD21



XB5AS8442



XB5AS86449B4



XB5AG61

■ Push Button dan Wireless Push Button

Tipe	Tegangan	Warna	Complete Set		
			Referensi	Harga (Rp) <i>(Sebelum PPN)</i>	SS
Flush	1 N/O	Hitam	XB5AA21	85.900	2
		Hijau	XB5AA31	85.900	2
		Kuning	XB5AA51	85.900	2
		Biru	XB5AA61	85.900	2
	1 N/C	Merah	XB5AA42	85.900	2
Flush ("I" white Marking)	1 N/O	Hijau	XB5AA3311	138.500	2
Flush ("O" white Marking)	1 N/C	Merah	XB5AA4322	136.000	2
Booted (IP 66)	1 N/O	Hitam	XB5AP21	154.000	2
		Hijau	XB5AP31	154.000	2
		Kuning	XB5AP51	154.000	2
		Merah	XB5AP42	154.000	2
Double Headed	1 N/O + 1 N/C	Hj, M	XB5AL73415	237.000	1
Wireless Pushbutton Not Programmable	1 C/O	Hijau	XB5RFB01	3.319.500	2
Wireless Pushbutton Programmable	2 C/O	Var	XB5RFA02	5.517.000	2

■ Selector Switch, Emergency Stop, dan Key Switch

Tipe	Kontak	Warna	Complete Set		
			Referensi	Harga (Rp) <i>(Sebelum PPN)</i>	SS
Selector					
2 posisi stay put	1 N/O	Hitam	XB5AD21	137.000	2
2 posisi spring return	1 N/O	Hitam	XB5AD41	209.000	2
3 posisi stay put	2 N/O	Hitam	XB5AD33	164.500	2
3 posisi spring return di kiri dan di kanan	2 N/O	Hitam	XB5AD53	172.500	2
Emergency Stop / Mushroom					
Latching Ø40 mm	1 N/C	Merah	XB5AT842	218.500	2
Latching turn to release Ø40 mm	1 N/C	Merah	XB5AS8442	175.000	2
Latching key release Ø40 mm	1 N/C	Merah	XB5AS9442	209.000	2
Latching Ø40 mm Standard Head	2 N/C 1 N/O	Merah	XB5AS84449	2.265.000	2
Illuminated E Stop LED Merah 24V	2 N/C 1 N/O	Merah	XB5AS86449B4	2.629.000	2
Illuminated Emergency Stop NEW					
E Stop Control Box Complete 24V	1 N/O 1 N/C	Merah	XALK84W3BE	991.000	2
E Stop Control Box Complete 24V	1 N/O 2 N/C	Merah	XALK84W3BG	1.052.500	2
Ø40 mm Illum Estop Control Box 24V	1 N/O 1 N/C	Merah	XALK178W3B140E	1.084.500	2
Ø40 mm Illum Estop Control Box 24V	1 N/O 2 N/C	Merah	XALK178W3B140G	1.084.500	2
Key Switch					
2 pos stay put cabut kunci di kiri	1 N/O	Hitam	XB5AG21	268.000	2
2 pos stay put cabut kunci di kiri & kanan	1 N/O	Hitam	XB5AG41	268.000	1
2 pos spring return cabut kunci di kiri	1 N/O	Hitam	XB5AG61	289.500	2
3 pos stay put cabut kunci di tengah	2 N/O	Hitam	XB5AG33	348.500	2

Illuminated
Emergency
Stop Button



XB5AS84W3B5



XALK84W3BE



XALK178W3B140G

Harmony XB5

Diameter 22 mm Modular Tipe Plastik

■ Pilot Lamp



XB5AVM5



XB5AVB3



XB5AV44

Tipe	Tegangan	Warna	Complete Set		
			Referensi	Harga (Rp) <i>(Sebelum PPN)</i>	SS
	24 V AC/DC	Putih	XB5AVB1	161.000	2
		Hijau	XB5AVB3	161.000	2
		Merah	XB5AVB4	161.000	2
		Jingga	XB5AVB5	161.000	2
		Biru	XB5AVB6	161.000	2
		Putih	XB5AVG1	184.500	2
Protected LED	110 ... 120 V AC	Hijau	XB5AVG3	184.500	2
		Merah	XB5AVG4	184.500	2
		Jingga	XB5AVG5	184.500	2
		Biru	XB5AVG6	184.500	2
		Putih	XB5AVM1	121.500	2
		Hijau	XB5AVM3	121.500	2
	230 ... 240 V AC	Merah	XB5AVM4	121.500	2
		Jingga	XB5AVM5	121.500	2
		Biru	XB5AVM6	121.500	2
		Putih	XB5AV41	285.500	2
		Hijau	XB5AV43	272.500	2
		Merah	XB5AV44	272.500	2
Dengan Trafo	230 V AC	Jingga	XB5AV45	272.500	2

Harmony XB5

Diameter 22 mm Modular Tipe Plastik



XB5BW34B5



XB5AW34M5

Tombol Iluminasi

Tipe	Tegangan	Kontak	Warna	Complete Set		
				Referensi	Harga (Rp) (Sebelum PPN)	SS
	24 V AC/DC	1 N/O+1 N/C	Putih	XB5AW31B5	245.000	2
			Hijau	XB5AW33B5	245.000	2
			Merah	XB5AW34B5	245.000	2
			Jingga	XB5AW35B5	245.000	2
			Biru	XB5AW36B5	245.000	2
Protected LED Termasuk lampu protected LED	110 ... 120 V AC	1 N/O + 1N/C	Putih	XB5AW31G5	299.000	2
			Hijau	XB5AW33G5	299.000	2
			Merah	XB5AW34G5	299.000	2
			Jingga	XB5AW35G5	299.000	2
			Putih	XB5AW31M5	227.500	2
	230 ... 240 V AC	1 N/O + 1N/C	Hijau	XB5AW33M5	227.500	2
			Merah	XB5AW34M5	227.500	2
			Jingga	XB5AW35M5	227.500	2
			Biru	XB5AW36M5	227.500	2
			Dengan Trafo termasuk bola lampu tipe BA9s, 6V	230 V AC	1 N/O + 1N/C	Hijau
			Merah	XB5AW3445	427.500	2
Protected LED Double Headed IP 66	24 V AC/DC			XB5AW73731B5	411.000	2
	48 ... 120 V AC	N/O + 1N/C	Hj,M	XB5AW73731G5	411.000	2
	230 ... 240 V AC			XB5AW73731M5	411.000	2

Selektor Iluminasi

Tipe	Tegangan	Kontak	Warna	Complete Set		
				Referensi	Harga (Rp) (Sebelum PPN)	SS
	24 V AC/DC	1 N/O + 1N/C	Hijau	XB5AK123B5	429.500	2
			Merah	XB5AK124B5	429.500	2
			Jingga	XB5AK125B5	429.500	2
Protected LED 2 position stay put	110 ... 120 V AC	1 N/O + 1N/C	Hijau	XB5AK123G5	429.500	2
			Jingga	XB5AK125G5	429.500	2
			Hijau	XB5AK123M5	429.500	2
	230 ... 240 V AC	1 N/O + 1N/C	Merah	XB5AK124M5	429.500	2
			Jingga	XB5AK125M5	429.500	2



XB5AK125M5

Potensiometer

Tipe	Tegangan	Resistensi	Complete Set		
			Referensi	Harga (Rp) (Sebelum PPN)	SS
Potensiometer R1K	Max 30VAC/42VDC	1 K Ohm	XB5AD912R1K	1.502.000	2
Potensiometer R10K	Max 30VAC/42VDC	10 K Ohm	XB5AD912R10K	1.502.000	1
Potensiometer R4K7	Max 30VAC/42VDC	4700 Ohm	XB5AD912R4K7	1.502.000	2
Potensiometer R47K	Max 30VAC/42VDC	47 K Ohm	XB5AD912R47K	1.502.000	2



XB5AD912R1K

Terdiri dari Body Plastik Diameter 22, Mounting dan Potensiometer

Harmony XB5

Diameter 22 mm Modular Tipe Plastik



ZB5AZ101



XB5PUSB3



XB5PRJ45

■ Aksesori (kontak tambahan)

Tipe	Referensi	Harga (Rp) (Sebelum PPN)	SS
Badan dengan kontak 1 N/O	ZB5AZ101	66.500	1
Badan dengan kontak 1 N/C	ZB5AZ102	66.500	1
Badan dengan kontak 2 N/O	ZB5AZ103	98.900	1
Badan dengan kontak 2 N/C	ZB5AZ104	98.900	2
Badan dengan kontak 1 N/O + 1 N/C	ZB5AZ105	98.900	2
Kontak 1 N/O**	ZBE101	43.800	1
Kontak 1 N/C**	ZBE102	43.800	1

Catatan : Penambahan kontak ** pada tombol tekan maksimum 9 kontak

■ USB dan RJ45 Panel Mounted

Tipe	Tegangan	Complete Set		
		Referensi	Harga (Rp) (Sebelum PPN)	SS
Port USB 3.0, diameter 22	USB Jack Type A	XB5PUSB3	730.000	2
RJ45 diameter 22	RJ45 Ethernet 10 Gbit/s	XB5PRJ45	586.000	2



XB5FA42



XB5FD25



XB5FG21



XB5KSB



XB5KS2G4

Harmony XB5

Diameter 30 mm Modular Tipe Plastik & Rata Panel

■ Push Button Rata Panel Tanpa Marking

Tipe	Kontak	Warna	Complete Set		
			Referensi	Harga (Rp) (Sebelum PPN)	SS
Flush/Permukaan Rata	1 N/O	Putih	XB5FA11	212.000	2
		Hitam	XB5FA21	216.000	2
		Hijau	XB5FA51	216.000	2
		Biru	XB5FA61	216.000	2
Projecting/Permukaan menonjol	1 N/C	Merah	XB5FA42	216.000	2
	1 N/C	Merah	XB5FL42	244.000	2

Catatan : tersedia juga kepala saja putih, hitam, hijau, merah, kuning, biru

■ Selector Switch Rata Panel dan Key Switch

Tipe	Kontak	Warna	Complete Set		
			Referensi	Harga (Rp) (Sebelum PPN)	SS
Selector Switch Handle Standard					
2 posisi stay put	1 N/O	Hitam	XB5FD21	295.500	2
2 posisi spring return	1 N/O	Hitam	XB5FD41	277.500	2
2 posisi stay put	1 N/O 1 N/C	Hitam	XB5FD25	367.000	2
3 posisi stay put	2 N/O	Hitam	XB5FD33	367.000	2
3 posisi spring return ke tengah	2 N/O	Hitam	XB5FD53	383.500	2
Key Switch					
2 posisi stay put cabut kunci di kiri	1 N/O	Hitam	XB5FG21	655.500	2
2 pos stay put cabut kunci di kiri & kanan	1 N/O	Hitam	XB5FG41	602.000	2
2 pos spring return cabut kunci di kiri	1 N/O	Hitam	XB5FG61	702.000	2
3 pos stay put cabut kunci di kanan kiri tengah	2 N/O	Hitam	XB5FG03	730.000	2
3 pos stay put cabut kunci di tengah	2 N/O	Hitam	XB5FG33	644.500	2

■ Buzzer/Annunciator (IP 66, IP 67, and IP 69) Diameter 22mm

Tipe	Tegangan	Warna	Complete Set		
			Referensi	Harga (Rp) (Sebelum PPN)	SS
Continuous or intermittent, Non Illuminated Buzzer, 90dB, 5/6.8kHz,	24 VAC/DC	Hitam	XB5KSB	1.159.000	2
	110...120 VAC/DC	Hitam	XB5KSG	1.984.500	2
	230...240VAC	Hitam	XB5KSM	1.617.000	2
Continuous or intermittent Illuminated buzzer 90dB 4/6.8kHz	24 VAC/DC	Merah	XB5KS2B4	679.000	2
	110...120 VAC/DC	Merah	XB5KS2G4	762.500	2
	230...240VAC	Merah	XB5KS2M4	692.000	2
	24 VAC/DC	Kuning	XB5KS2B8	679.000	2
	110...120 VAC/DC	Kuning	XB5KS2G8	762.500	2
	230...240VAC	Kuning	XB5KS2M8	692.000	2

Harmony XB5

Diameter 30 mm Modular Tipe Plastik, Rata Panel

■ Pilot Lamp Rata Panel



XB5FVB4



XB5FVB6

Tipe	Kontak	Warna	Complete Set		
			Referensi	Harga (Rp) <i>(Sebelum PPN)</i>	SS
	24 V AC/DC	Putih	XB5FVB1	259.000	2
		Hijau	XB5FVB3	259.000	2
		Merah	XB5FVB4	259.000	2
		Jingga	XB5FVB5	259.000	2
		Biru	XB5FVB6	259.000	2
		Protected LED	110 ... 120 V AC	Putih	XB5FVG1
		Hijau	XB5FVG3	312.000	2
		Merah	XB5FVG4	312.000	2
		Jingga	XB5FVG5	312.000	2
		Biru	XB5FVG6	312.000	2
	230 ... 240 V AC	Putih	XB5FVM1	428.500	2
		Hijau	XB5FVM3	428.500	2
		Merah	XB5FVM4	428.500	2
		Jingga	XB5FVM5	428.500	2
		Biru	XB5FVM6	428.500	2

■ Tombol Iluminasi Rata Panel



XB5FW35B5



XB5FW33M5

Tipe	Tegangan	Kontak	Warna	Complete Set		
				Referensi	Harga (Rp) <i>(Sebelum PPN)</i>	SS
	24 V AC/DC	1 N/O+1 N/C	Putih	XB5FW31B5	474.500	2
			Hijau	XB5FW33B5	474.500	2
			Merah	XB5FW34B5	474.500	2
			Jingga	XB5FW35B5	474.500	2
			Biru	XB5FW36B5	474.500	2
			Protected LED Termasuk lampu protected LED	110 ... 120 V AC	1 N/O + 1N/C	Putih
		Hijau	XB5FW33G5	517.500	2	
		Merah	XB5FW34G5	517.500	2	
		Jingga	XB5FW35G5	517.500	2	
	230 ... 240 V AC	1 N/O + 1N/C	Putih	XB5FW31M5	639.500	2
		Hijau	XB5FW33M5	639.500	2	
		Merah	XB5FW34M5	639.500	2	
		Jingga	XB5FW35M5	639.500	2	
		Biru	XB5FW36M5	639.500	2	

■ Selector Switch Iluminasi Rata Panel



XB5FK124G5



XB5FK135M5

Tipe	Kontak	Tegangan	Warna	Complete Set		
				Referensi	Harga (Rp) <i>(Sebelum PPN)</i>	SS
Selector Switch Handle Standard						
2 Posisi Stay Put	1 N/O 1 N/C	24 V AC/DC	Hijau	XB5FK123B5	658.000	2
			Merah	XB5FK124B5	633.000	2
			Jingga	XB5FK125B5	646.000	2
		110 ... 120 V AC	Hijau	XB5FK123G5	644.500	2
			Merah	XB5FK124G5	596.500	2
			Jingga	XB5FK125G5	596.500	2
3 Posisi Stay Put		230 ... 240 V AC	Hijau	XB5FK123M5	794.000	2
			Merah	XB5FK124M5	794.000	2
			Jingga	XB5FK125M5	810.000	2
		24 V AC/DC	Hijau	XB5FK133B5	621.000	2
			Merah	XB5FK134B5	621.000	2
			Jingga	XB5FK135B5	621.000	2
	110 ... 120 V AC	110 ... 120 V AC	Hijau	XB5FK133G5	663.000	2
			Merah	XB5FK134G5	663.000	2
			Jingga	XB5FK135G5	663.000	2
		230 ... 240 V AC	Hijau	XB5FK133M5	780.000	2
			Merah	XB5FK135M5	780.000	2
			Jingga	XB5FK135M5	780.000	2

Harmony XB7

Diameter 22 mm Monolitik IP65



XB7NA42



XB7NA31



XB7EV04MP



XB7EV03MP



XB7ND33



XB7NS8445

Push Button

Tipe	Kontak	Warna	Complete Set		
			Referensi	Harga (Rp) (Sebelum PPN)	SS
Flush	1 N/O	Hitam	XB7NA21	74.000	2
		Hijau	XB7NA31	74.000	1
	1 N/C	Merah	XB7NA42	74.000	1
		Hitam	XB7NA25	124.500	2
		Hijau	XB7NA35	124.500	2
Latching	1 N/O	Hitam	XB7NH21	96.700	2
		Hijau	XB7NH31	98.900	2
	1 N/O + 1 N/C	Hitam	XB7NH25	129.500	2
		Hijau	XB7NH35	129.500	2
		Tombol Iluminasi < 250 V (tidak termasuk bola lampu)	1 N/O	Hijau	XB7NW3361
		Merah	XB7NW3461	164.500	2

Pilot Lamp

Tipe	Tegangan	Warna	Complete Set		
			Referensi	Harga (Rp) (Sebelum PPN)	SS
Protected LED	230 ... 240 V AC	Hijau	XB7EV03MP	85.900	1
		Merah	XB7EV04MP	85.900	1
		Kuning	XB7EV05MP	85.900	1
		Biru	XB7EV06MP	85.900	1
		Bening	XB7EV07MP	85.900	1
		Jingga	XB7EV08MP	85.900	1

Catatan :

- Untuk kebutuhan Pilot Lamp dengan tegangan suplai 24 V AC/DC, gantikan kode **MP** dengan **BP** pada referensi Pilot Lamp.
- Untuk kebutuhan Pilot Lamp dengan tegangan suplai 120 VAC, gantikan kode **MP** dengan **GP** pada referensi Pilot Lamp.

Selector Switch dan Emergency Stop

Tipe	Kontak	Warna	Referensi	Harga (Rp) (Sebelum PPN)	SS
Selector					
2 posisi stay put	1 N/O	Hitam	XB7ND21	109.500	2
3 posisi stay put	2 N/O	Hitam	XB7ND33	133.500	1
Emergency Stop					
Latching	1 N/C	Merah	XB7NS8442	168.500	2
Turn to Release	1 N/O + 1 N/C	Merah	XB7NS8445	168.500	1

Catatan : Untuk kebutuhan produk Push Button, Pilot Lamp dan komponen panel lainnya dengan diameter 16 mm dan 30 mm, silakan hubungi kami.



K1A001ALH



K1B001ULH

Cam Switch

Sakelar Kendali dan Daya IP 40

■ Sakelar OFF - ON

Tipe	Pole	Mounting	Arus	Referensi	Harga (Rp) (Sebelum PPN)	SS
OFF ON sudut 45 derajat	1	2 & 4 lubang	12 A	K1A001ALH	378.000	2
	2	2 & 4 lubang	20 A	K2A001ALH	536.500	2
	3	2 & 4 lubang	12 A	K1B002ALH	557.000	2
			20 A	K2C003ALH	756.000	2

■ Sakelar Alih

Tipe	Pole	Mounting	Arus	Referensi	Harga (Rp) (Sebelum PPN)	SS
Dengan posisi 0 / OFF	1	2 & 4 lubang	12 A	K1B001ULH	442.000	2
			20 A	K2B001ULH	498.000	2
	2	2 & 4 lubang	12 A	K1D002ULH	762.000	2
			20 A	K2D002ULH	881.500	2
	3	2 & 4 lubang	12 A	K1F003ULH	941.500	2
			20 A	K2F003ULH	1.110.000	2



XALD102



XALD112



XALK178



XALD213



XALD324

Panel Kendali

Panel Kendali XAL Tipe Plastik

■ Panel Kendali Terpasang

Kontak	Tipe	Referensi	Harga (Rp) (Sebelum PPN)	SS
1 N/O	Start	XALD102	434.000	2
1 N/C	Stop	XALD112	586.500	2
1 N/C	Emergency stop, merah, spring return	XALD164	696.500	2
	Emergency stop, merah, turn to release	XALK178	500.500	1
1 N/O + 1 N/C	Start - Stop	XALD213	458.000	1
	Start - Stop, dengan lampu indikasi LED 24V AC/DC	XALD363B	975.500	2
	Start - Stop, dengan lampu indikasi LED 220V AC	XALD363M	734.500	2
2 N/O + 1 N/C	Maju - Stop - Mundur	XALD334	903.000	2
	Naik - Stop - Turun	XALD324	903.000	2

■ Panel Kendali Kosong

Tipe	Jumlah Lubang	Referensi	Harga (Rp) (Sebelum PPN)	SS
<i>Enclosure plastik kosong untuk control station dengan diameter lubang 22 mm</i>	1	XALD01	134.500	1
	2	XALD02	211.500	1
	3	XALD03	252.500	1
	4	XALD04	325.500	1
	5	XALD05	501.500	2
	1	XALKW01	844.500	2

■ Blok Kontak

Tipe	Kontak	Referensi	Harga (Rp) (Sebelum PPN)	SS
Badan Kontak dan kontak tambahan	1 N/O	ZENL1111	76.700	1
	1 N/C	ZENL1121	76.700	1



XALKW01

Panel Kendali kosong untuk
Illuminated Emergency Stop

Panel Kendali

Panel Kendali XAP Tipe Metal

■ Panel Kendali Kosong



XAPD1202

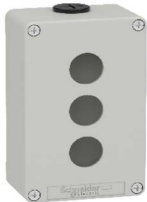

XAPD2203

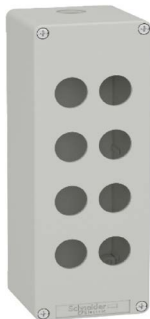

XAPD4508

Tipe	Dimensi (mm)		Jumlah Lubang			Referensi	Harga (Rp) (Sebelum PPN)	SS
	P	L	total	ver	hor			
Tipe Zinc alloy <i>Enclosure</i> kosong untuk control station dengan warna biru, terbuat dari bahan zinc alloy, IP 65, tebal 49mm	80	80	1	1	1	XAPD1201	1.526.500	2
			2	2	1	XAPD1202	2.244.000	2
	80	130	2	1	2	XAPD2202	1.362.500	2
			3	1	3	XAPD2203	1.444.000	2
			4	2	2	XAPD2204	2.578.500	2
			3	1	3	XAPD3203	2.625.000	2
80	175	4	1	4	XAPD3204	2.625.000	2	
		6	2	3	XAPD3206	2.625.000	2	
		1	1	1	XAPD1501	2.424.500	2	
Tipe Zinc alloy <i>Enclosure</i> kosong untuk control station dengan warna biru, terbuat dari bahan zinc alloy, IP 65, tebal 74,5mm	80	80	2	2	1	XAPD1502	2.424.500	2
			2	1	2	XAPD2502	3.002.000	2
	80	130	3	1	3	XAPD2503	3.002.000	2
			4	2	2	XAPD2504	3.002.000	2
			3	1	3	XAPD3503	2.769.000	2
			4	1	4	XAPD3504	2.796.500	2
80	175	6	2	3	XAPD3506	2.796.500	2	
		6	1	6	XAPD4506	4.990.000	2	
80	220	8	2	4	XAPD4508	4.990.000	2	
		8	1	8	XAPD5508	9.091.500	2	
Tipe aluminium 74,5 mm bahan aluminium alloy	85	310	12	2	6	XAPD5512	9.091.500	2

Catatan : Gunakan produk push button dan pilot lamp jenis XB4 untuk dipasang pada panel kendali tipe XAP ini.

Tower Light



XVM

■ Tower Light LED XVM + Diameter 45mm

Jumlah	Tegangan	Warna Steady	Referensi	Harga (Rp) (Sebelum PPN)	SS
2	24V AC/DC	Merah-Hijau	XVMB2RGSB	1.220.000	2
	120V AC/DC	Merah-Hijau	XVMG2RGSB	1.539.000	2
	230V AC/DC	Merah-Hijau	XVMM2RGSB	1.524.000	2
3	24V AC/DC	Merah-Oranye-Hijau	XVMB2RAGSB	1.627.500	2
	120V AC	Merah-Oranye-Hijau	XVMG2RAGSB	2.029.500	2
	230V AC	Merah-Oranye-Hijau	XVMM2RAGSB	2.032.000	2
4	24V AC/DC	Merah-Oranye-Hijau-Biru	XVMB2RAGBSB	2.036.000	2

Catatan :

- Produk indicator banks tipe XVM juga memungkinkan untuk dirakit sendiri dengan pilihan warna yang disesuaikan dengan keinginan pelanggan. Silakan hubungi kami untuk penentuan referensinya.
- Tersedia juga produk indicator banks yang dilengkapi dengan buzzer ataupun tipe cahaya flashing/flash.

■ Tower Light LED XVG Diameter 60mm

Jumlah	Tegangan	Warna Steady	Referensi	Harga (Rp) (Sebelum PPN)	SS
Base Mounting	24V AC/DC	Merah-Hijau	XVGB2W	750.000	2
		Merah-Oranye-Hijau	XVGB3W	849.500	2
		Merah-Oranye-Hijau-Biru	XVGB4W	1.080.000	2
Direct Aluminium Tube Mounting	24V AC/DC	Merah-Hijau	XVGB2T	774.000	2
		Merah-Oranye-Hijau	XVGB3T	878.000	2
Aluminium Tube Mounting & L-Bracket	24V AC/DC	Merah-Hijau	XVGB2	797.000	2
		Merah-Oranye-Hijau	XVGB3	907.000	2
Aluminium Tube Mounting & Fixing Plate	24V AC/DC	Merah-Oranye-Hijau-Biru	XVGB4	1.137.500	2
		Merah-Hijau	XVGB2H	798.500	2
		Merah-Oranye-Hijau	XVGB3H	907.000	2
Aluminium Tube Mounting & Foldable Bracket	24V AC/DC	Merah-Oranye-Hijau-Biru	XVGB4H	1.137.500	2
		Merah-Hijau	XVGB2M	878.000	2
		Merah-Oranye-Hijau	XVGB3M	1.013.500	2
		Merah-Oranye-Hijau-Biru	XVGB4M	1.270.000	2

Catatan :

- Produk indicator banks tipe XVG di atas belum dilengkapi dengan buzzer.
- Tersedia pula produk indicator banks XVG yang dilengkapi dengan buzzer. Silakan hubungi kami untuk penentuan referensinya.



XVGB2T

XVGB4W



XVGB3H

XVGB3M



Untuk Tower Light lain silakan Scan QR Code.



XPEM110



XPEM110



XACA481



XACA291

■ Foot Switch XPE

Tipe	Operasi	Kontak	Referensi	Harga (Rp) (Sebelum PPN)	SS
Foot switch untuk Security, dilengkapi dengan protective-guard, warna biru	1 step	1 C/O	XPEM510	2.908.500	2
	2 step	2 C/O	XPEM711	3.932.000	2
Foot switch tanpa protective guard, insulasi ganda	1 step	1 C/O	XPEA110	915.500	2
Foot switch tanpa protective guard, terbuat dari metal	1 step	1 C/O	XPEM110	1.875.000	1
	2 step	2 C/O	XPEM211	2.573.000	2

■ Pendant/Crane Controller

Tipe	Kontak Blok	Jumlah Lubang	Referensi	Harga (Rp) (Sebelum PPN)	SS
Kecepatan Tunggal					
2 Arah		2	XACA281	1.414.000	2
4 Arah	1 N/C + 1 N/O untuk tiap arah	4	XACA481	1.155.000	1
6 Arah		6	XACA681	1.509.500	2
6 Arah + ON + STOP		8	XACA881	1.873.000	1
Kecepatan Ganda					
2 Arah		2	XACA291	1.523.000	2
2 Arah + Emergency Stop	1 N/C + 1 N/O + NO staggered untuk tiap arah	3	XACA2913	2.014.000	2
4 Arah		4	XACA491	2.031.000	2
4 Arah + Emergency Stop		5	XACA4913	2.570.000	2



Life Is On

Schneider
Electric



Harmony Control Relay	15-4
Relay Kontrol dan Pengukuran	15-5
Relay Kontrol Fasa	15-5
Relay Kontrol Tegangan	15-5
Relay Kontrol Arus	15-5
Relay Kontrol Level	15-6
Harmony Electromechanical Relay	15-7
Relay Miniature Easy RXM-LB 3A sampai dengan 5A	15-8
Relay Miniature Easy RXM-AB 6A sampai dengan 12A	15-9
Relay Universal RUM 3A & 10A	15-10
Relay Power RPM 15A & Relay Power RPF 30A	15-11
Relay Interface RXG 5A & 10A	15-12
Relay Interface RSB 8A & 16A	15-13
Super Slim Relay RSL 6mm	15-14
Harmony Timer Relay	15-15
Miniature Plug In Timer REXL & RE17	15-16
Zelio Logic	15-17
Smart Relay SR2	15-17
Smart Relay SR2 & SR3	15-18
Power Supply	15-20
Phaseo ABL2 - Panel Mounting Phaseo	15-20
Modicon ABLM & ABLS & ABL8 - DIN Rail Mounting	15-21
Modular, Optimum, & Universal	15-22
Industrial Automation Systems	15-23
EcoStruxure Automation Expert	15-23
Easy Harmony iPC	15-24
Industrial PC, Edge Box dan Display	15-24
Harmony iPC HMIP6	15-25
Industrial PC, Edge Box dan Display	15-25
Easy Harmony ET6	15-26
Solusi HMI untuk aplikasi otomasi sederhana	15-26
Easy Proface ET6000	15-27
Solusi HMI untuk aplikasi otomasi sederhana	15-27
Modicon M221	15-28
Logic Kontroler & Book Logic Kontroler	15-29
Modicon M241	15-30
Logic Kontroler	15-31
Modicon M251	15-32
Logic Kontroler	15-33
Modicon M262	15-34
Logic Kontroler	15-34



Modicon TM3	15-36
Modicon TM3 Digital I/O modul	15-37
Modicon TM3 Analog I/O modul	15-38
Modicon TM3 Functional Safety Modul	15-39
Modicon TM3 Bus Expansion System	15-40
Modicon Easy M100	15-41
Logic Kontroler untuk aplikasi sederhana sampai dengan 40 I/O	15-42
Modicon Easy M200	15-43
Logic Kontroler untuk aplikasi sederhana sampai dengan 188 I/O	15-44
Easy Lexium 18	15-45
Easy Lexium 18 range	15-45
Easy Lexium 18 servo drive and BCH18 motor combination	15-46
Easy Lexium 18 servo drives	15-47
Panduan Pemilihan, Dimensi & Berat, Deskripsi	15-47
Connection accessories	15-48
Braking resistor	15-49
Additional EMC input filters	15-50
Motor starters & Protection using class J fuses (UL certification)	15-51
Easy Lexium BCH18 servo motors	15-52
Presentasi & Deskripsi	15-52
Holding brake controller & Integrated encoder	15-52
Panduan Pemilihan	15-53
Dimensi & Berat	15-54
Connection components	15-55
- Unshielded Power cables	15-55
- Motor power connector kits	15-56
- Shielded Encoder cables & Motor encoder connector kits	15-57



Scan untuk Data Teknis

Harmony Control Relay

Schneider Harmony Control Relay sangat penting digunakan karena :

- 45%

Aplikasi elektrikal digunakan untuk motor
- 30%

Kegagalan motor dari overloading
- 14%

dari Phase Lose



Dengan Schneider Harmony Control Relay kita dapat

- Menghindari biaya kerusakan motor.
- Memperoleh Alert pada kondisi operasi abnormal.
- Menambah lifetime motor.

■ Cara Pemilihan Harmony Control Relay Nomenclature

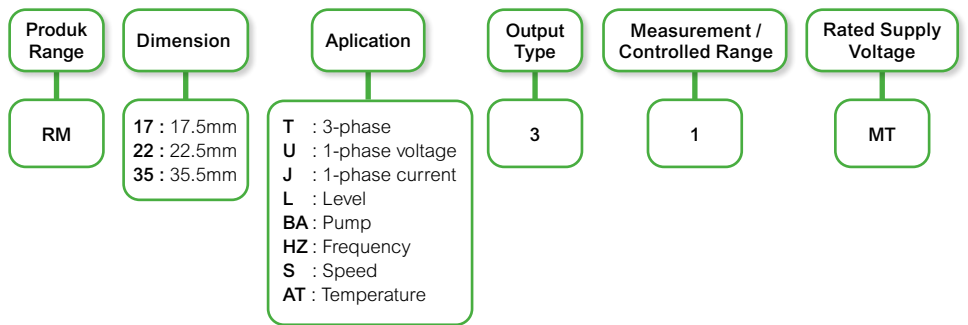

How Does a Control Relay Work?

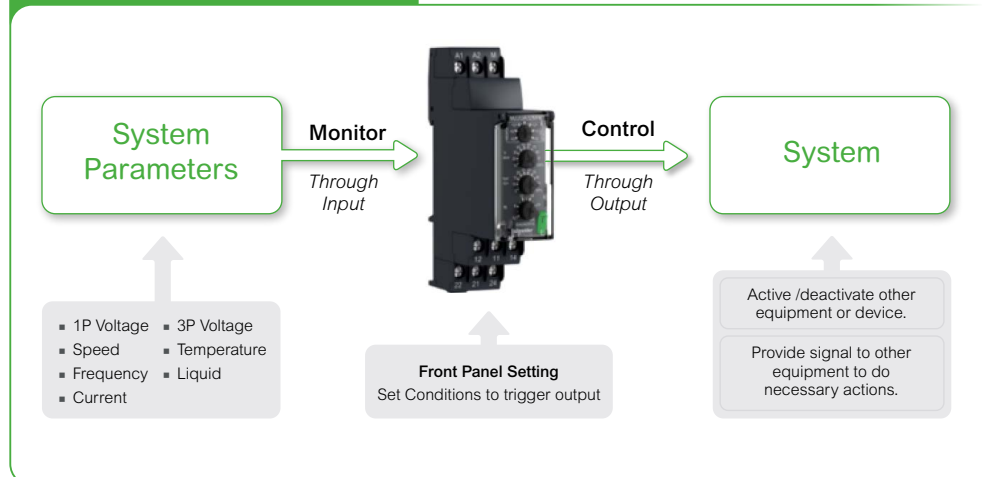

■ Kontrol Fasa

Fungsi	Nilai Kontrol	Output	Referensi	Harga (Rp) (Sebelum PPN)	SS
Suplai Daya Self Powered 208 ... 480 V AC					
Hilang fasa dan urutan fasa	208 ... 480 V AC	1 C/O relay 5 A	RM17TG00	1.071.000	2
Hilang fasa dan urutan fasa	208 ... 480 V AC	2 C/O relay 5 A	RM17TG20	1.018.500	1
Hilang fasa dan urutan fasa	208/220/380/400/415/440/480 VAC	1 C/O relay 5 A	RM17TT00	1.125.000	2
Hilang fasa, urutan fasa, dan undervoltage	-2 to -20 Un	1 C/O relay 5 A	RM17TU00	1.125.000	2
Hilang fasa, urutan fasa, dan unbalance	Unbalance 5 to 15%	1 C/O relay 5 A	RM17TA00	1.784.000	2
Hilang fasa, urutan fasa, dan unbalance Over/undervoltage	Unbalance 5 to 15% 2 to 20% Un phase/phase	1 C/O relay 5 A	RM17TE00	1.785.000	1
Hilang fasa, urutan fasa, dan unbalance Overvoltage/Undervoltage	Unbalance 5 to 15% Overvoltage 2 to 20% Un phase/phase Undervoltage -20 to -2% Un phase/phase	2 C/O relay 5 A**	RM35TF30	2.315.000	1
Over/undervoltage antar fasa	Overvoltage 2 to 20% Un phase/phase Undervoltage -20 to -2% Un phase/phase	2 C/O relay 5 A	RM35UB330	1.984.500	1
Over/undervoltage antara fasa ke netral	Overvoltage 2 to 20% Un phase/neutral Undervoltage -20 to -2% Un phase/neutral	2 C/O relay 5 A	RM35UB3N30	2.117.000	2
Over/undervoltage antar fasa	Overvoltage 2 to 20% Un phase/phase Undervoltage -20 to -2% Un phase/phase	1 C/O relay 5 A	RM17UB310	1.488.500	2

Suplai Daya Self Powered 24 ... 240 V AC/DC 50/60 Hz					
Hilang fasa dan urutan fasa Proteksi termal PTC	208...480 VAC Auto reset	2 NO relay 5 A	RM35TM50MW	2.300.500	2
Hilang fasa dan urutan fasa Proteksi termal PTC	Selectable fault memorization Remote reset, fault test pushbutton	2 NO relay 5 A	RM35TM250MW	2.354.500	2

■ Kontrol Tegangan (Over dan Undervoltage)

Suplai Daya	Nilai Kontrol	Output	Referensi	Harga (Rp) (Sebelum PPN)	SS
Self-powered 12 VDC	9 s/d 15 V DC	1 C/O relay 5 A	RM17UAS14	1.103.000	2
Self-powered 20 to 80 VAC/DC	20 s/d 80 V AC/DC	1 C/O relay 5 A	RM17UAS16	1.103.000	2
Self-powered 65 to 260 VAC/DC	65 s/d 260 V AC/DC	1 C/O relay 5 A	RM17UAS15	1.103.000	2
Self-powered 20 to 80 VAC/DC	20 s/d 80 V AC/DC	1 C/O relay 5 A	RM17UBE16	1.168.500	2
Self-powered 65 to 260 VAC/DC	65 s/d 260 V AC/DC	1 C/O relay 5 A	RM17UBE15	1.168.500	1
20 to 240 VAC/DC 50/60 Hz	0.05 ... 0.5 V ; 0.3 ... 3 V ; 0.5 ... 5 V	2 C/O relay 5 A	RM35UA11MW	1.252.000	2
20 to 240 VAC/DC 50/60 Hz	1 ... 10 V ; 5 ... 50 V ; 10 ... 100 V	2 C/O relay 5 A	RM35UA12MW	1.252.000	2
20 to 240 VAC/DC 50/60 Hz	15 ... 150 V ; 30 ... 300 V ; 60 ... 600 V	2 C/O relay 5 A	RM35UA13MW	1.491.000	1

■ Kontrol Arus

Fungsi (Suplai Daya 24 ... 240 V AC/DC 50/60 Hz)	Nilai Kontrol	Output	Referensi	Harga (Rp) (Sebelum PPN)	SS
Overcurrent	2...20 A dengan integrated toroid	1 C/O relay 5 A	RM17JC00MW	1.360.000	2
Over atau undercurrent	2...200 mA 10...100 mA 50 V...500 mA	2 C/O relay 5 A*	RM35JA31MW	1.252.000	2
	0.15...1.5 A 0.5...5 A 1.5...15 A	2 C/O relay 5 A*	RM35JA32MW	1.488.500	2

Catatan :
*) 2 C/O DPDT 5 A



Scan untuk
Data Teknis



Scan untuk
Data Teknis



RM35 ●

Harmony Control Relay

Relay Kontrol dan Pengukuran

■ Kontrol Frekuensi (Over dan Underfrequency)









Suplai Daya	Nilai Kontrol	Output	Referensi	Harga (Rp) (Sebelum PPN)	SS
120 to 277 VAC 50/60 Hz	Upper threshold: -2 to +10 Hz Lower threshold: -10 to +2 Hz	2 C/O relays 5 A	RM35HZ21FM	1.841.000	2

■ Kontrol Level

Fungsi	Nilai Kontrol	Output	Referensi	Harga (Rp) (Sebelum PPN)	SS
(Suplai Daya 24 ... 240 V AC/DC 50/60 Hz)					
Drain to fill	0.25...5 kΩ 5...100 kΩ 0.05...1 MΩ	2 C/O relays 5 A**	RM35LM33MW	1.180.000	1
Drain to fill	Sensor discrete input: contact/positive switching/negative switching	1 C/O relay 5 A	RM35LV14MW	1.583.000	2
Suspended probe 1 electrode + 1 ref.			LA9RM201	1.471.500	2
Suspended protected probe			RM79696043	312.000	2

Harmony Electromechanical Relay

Harmony Electromechanical Relay memiliki fungsi utama sebagai interfacing (switching, isolating, amplifying dan multiplying)

Slim			Miniature		Universal		Power	
								
SPDT	SPDT/DPDT	SPDT/DPDT	DPDT, 3PDT, 4PDT		DPDT, 3PDT, 4PDT		SPDT, DPDT, 3PDT, 4PDT	
6 A	8-12-16 A	10-5 A	3-5 A	6-10-12 A	3-5 A	6-10-12 A	15 A	30 A
PCB Pins	PCB Pins	Flat Pins	Flat Pins	Flat Pins	Flat Pins	Flat Pins	Flat Pins	Flat Pins
RSL	RSB	RXG	RXM●LB	RXM●AB	RUM		RPM	RPF

Save up to
65%
 wiring time



RXZE2S108M
Separate Screw Connector For 2C/O



RXZES111M
Separate Screw Connector For 3C/O



RXZE2S114M
Separate Screw Connector For 2 and 4C/O



RXZE2M114
Separate Screw Connector For 2 and 4C/O



RXZE2M114M
Separate Screw Connector For 2 and 4C/O



RXZE2S114S
Separate Screw Connector For 2 and 4C/O



Both IEC and NEMA marking on all RXM sockets

Separate VS Mixed

Common	NO
NO	NC
NC	
	Coil
Coil	Common

Screw Connector



Screw Clamp



Push and Stay



Push and stay spring clamp terminal: insert without tool

Harmony Relay Rated Coil Voltage Referensi

No	AC		DC	
	Ref.	Voltage	Ref.	Voltage
1	*B7	24 VAC	*JD	12 VDC
2	*E7	48 VAC	*BD	24 VDC
3	*N7	60 VAC	*HD	30 VDC
4	*G7	110 VAC	*CD	36 VDC
5	*F7	120 VAC	*ED	48 VDC
6	*K7	127 VAC	*ND	60 VDC
7	*P7	230 VAC	*FD	110 VDC
8	*U7	240 VAC	*GD	125 VDC
9			*MD	220 VDC
10			*UD	250 VDC



Tersedia juga Tipe SSR Solid State Relay 1NO contact/ 10A.....125A



Scan untuk
Data Teknis



RXM●LB2●●



RXZE1M2C

Easy Harmony Electromechanical Relay

Relay Miniature Easy RXM-LB 3A sampai dengan 5A

■ Panorama Produk RXM-LB

Jumlah Pin	Jumlah Kontak C/O	Arus (A)	LED	Referensi	Harga (Rp) <i>(Sebelum PPN)</i>	SS
Aplikasi Standard (pin pipih)						
8	2	5	-	RXM2LB1●●	71.700	1
			√	RXM2LB2●●	74.400	1
14	4	3	-	RXM4LB1●●	82.400	1
			√	RXM4LB2●●	88.300	1

Catatan :

- Gantikan kode ●● pada referensi untuk tegangan kontrol koil sesuai dengan tabel dibawah yang diikuti dengan Status Stock (SS):

Koil	24 V DC	230 V AC
Kode ●●	BD (1)	P7 (1)

- Untuk tipe tegangan koil lainnya silakan menghubungi customer care center kami.
- Harga untuk coil selain **BD** dan **P7** ada kemungkinan berbeda dengan daftar harga di atas.

■ Soket

Terminal	Koneksi	Untuk tipe relay	Referensi	Harga (Rp) <i>(Sebelum PPN)</i>	SS
Tercampur	Screw clamp Connector	RXM2LB	RXZE1M2C	40.700	1
		RXM2LB & RXM4LB	RXZE1M4C	49.800	1



Scan untuk
Data Teknis



RXM●AB2●●
+
Soket

i RXM*AB dilengkapi dengan tombol tes manual

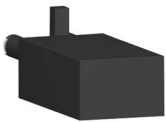

RXM040W

Harmony Electromechanical Relay

Relay Miniature Easy RXM-AB 6A sampai dengan 12A

■ Panorama Produk RXM-AB

Jumlah Pin	Jumlah Kontak C/O	Arus (A)	LED	Referensi	Harga (Rp) (Sebelum PPN)	SS
Aplikasi Standard (pin pipih)						
8	2	12	-	RXM2AB1●●	124.500	1
			√	RXM2AB2●●	140.000	1
11	3	10	-	RXM3AB1●●	138.500	2
			√	RXM3AB2●●	152.000	2
14	4	6	-	RXM4AB1●●	116.500	1
			√	RXM4AB2●●	140.000	1

Catatan :

- Gantikan kode ●● pada referensi untuk tegangan kontrol koil sesuai dengan tabel dibawah:

Koil	24 V DC	230 V AC
Kode ●●	BD	P7

- Dilengkapi dengan tombol tes manual.
- Untuk tipe tegangan koil lainnya silakan menghubungi customer care center kami.
- Harga untuk coil selain **BD** dan **P7** ada kemungkinan berbeda dengan daftar harga di atas.

■ Soket

Terminal	Koneksi	Untuk tipe relay	Referensi	Harga (Rp) (Sebelum PPN)	SS
Connector	Screw clamp terminal	RXM2 dan RXM4	RXZE2M114	57.300	1
	Screw connector	RXM2 dan RXM4	RXZE2M114M	61.100	1
Terpisah	Screw connector	RXM2	RXZE2S108M	57.300	1
		RXM3	RXZE2S111M	59.400	2
		RXM4	RXZE2S114M	64.800	1

Catatan : Terminal terpisah antara koil dan kontak digunakan untuk menghindari kesalahan pengkabelan

■ Modul Proteksi

Deskripsi	Tegangan	Referensi	Harga (Rp) (Sebelum PPN)	SS
Modul Diode	6 ... 230 V DC	RXM040W	42.700	1
Modul RC	24 ... 60 VAC	RXM041BN7	54.000	2
	110 ... 240 V AC	RXM041FU7	54.000	2
Modul Varistor	6 ... 24 V AC/DC	RXM021RB	58.400	2
	24 ... 60 V AC/DC	RXM021BN	58.400	2
	110 ... 230 V AC/DC	RXM021FP	58.400	2



Scan untuk
Data Teknis



RUMC●●●●●
+
Soket

RUM dilengkapi dengan
tombol tes manual

Harmony Electromechanical Relay

Relay Universal RUM 3A & 10A

■ Panorama Produk RUM

Jumlah Pin	Jumlah Kontak C/O	Arus (A)	LED	Referensi	Harga (Rp) (Sebelum PPN)	SS
Aplikasi Standard (pin pipih)						
8	2	10	-	RUMF21●●	543.500	2
			√	RUMF22●●	719.000	2
11	3	10	-	RUMF31●●	614.000	2
			√	RUMF32●●	680.000	2
Aplikasi Standard (pin bulat)						
8	2	10	-	RUMC21●●	205.500	2
			√	RUMC22●●	235.500	2
11	3	10	-	RUMC31●●	242.000	2
			√	RUMC32●●	260.500	2

Catatan :

- Gantikan kode ●● pada referensi untuk tegangan kontrol koil sesuai dengan tabel dibawah yang diikuti dengan Status Stock (SS)

Koil	24 V DC	230 V AC
Kode ●●	BD (1)	P7 (1)

- Untuk tipe tegangan koil lainnya silakan menghubungi customer care center kami.
- Harga untuk coil selain **BD** dan **P7** ada kemungkinan berbeda dengan daftar harga di atas.

■ Soket

Terminal	Koneksi	Untuk tipe relay	Referensi	Harga (Rp) (Sebelum PPN)	SS
Tercampur	Connector	RUMC2	RUZC2M	53.000	2
		RUMC3	RUZC3M	78.300	1
Terpisah	Connector	RUMC2	RUZSC2M	75.600	2
		RUMC3	RUZSC3M	118.500	2
		RUMF2 dan RUMF3	RUZSF3M	102.000	2

Catatan : Terminal terpisah antara koil dan kontak digunakan untuk menghindari kesalahan pengkabelan

■ Modul Proteksi

Deskripsi	Tegangan	Referensi	Harga (Rp) (Sebelum PPN)	SS
Modul Diode	6 ... 250 V DC	RUW240BD	43.800	2
Modul RC	110 ... 240 V AC	RUW241P7	54.000	2
Modul Varistor	24 V AC/DC	RUW242B7	54.000	2
	240 V AC/DC	RUW242P7	54.000	2



Scan untuk
Data Teknis



RPM42●●
+
Soket

Harmony Electromechanical Relay

Relay Power RPM 15A & Relay Power RPF 30A

■ Panorama Produk RPM

Jumlah Pin	Jumlah Kontak C/O	Arus (A)	LED	Referensi	Harga (Rp) <i>(Sebelum PPN)</i>	SS
Aplikasi Standard (pin pipih)						
5	1	15	-	RPM11●●	112.500	2
			√	RPM12●●	117.500	2
8	2	15	-	RPM21●●	141.000	2
			√	RPM22●●	153.000	1
11	3	15	-	RPM31●●	246.000	2
			√	RPM32●●	Hub Kami	
14	4	15	-	RPM41●●	240.500	2
			√	RPM42●●	263.000	1

Catatan :

- Gantikan kode ●● pada referensi untuk tegangan kontrol koil sesuai dengan tabel dibawah yang diikuti dengan Status Stock (SS)

Koil	24 V DC	230 V AC
Kode ●●	BD	P7

- Untuk tipe tegangan koil lainnya silakan menghubungi customer care center kami.
- Harga untuk coil selain **BD** dan **P7** ada kemungkinan berbeda dengan daftar harga di atas.

■ Soket

Terminal	Koneksi	Untuk tipe relay	Referensi	Harga (Rp) <i>(Sebelum PPN)</i>	SS
Tercampur	Screw Clamp	RPM1	RPZF1	84.800	2
		RPM2	RPZF2	96.700	1
		RPM3	RPZF3	116.500	2
		RPM4	RPZF4	120.000	1



Scan untuk
Data Teknis



RXG22●●
+
Soket



RXG23●●



RGZE1S35M

Harmony Electromechanical Relay Relay Interface RXG 5A & 10A

■ Panorama Produk RXG

Jumlah Kontak C/O	Arus (A)	Tegangan Koil	LED	Referensi	Harga (Rp) (Sebelum PPN)	SS
Aplikasi Standard (pin pipih) <u>Dilengkapi</u> Tombol Tes Manual						
1	10	24V DC	-	RXG11BD	106.000	2
		24V DC	√	RXG12BD	117.500	2
		230V AC	-	RXG11P7	Hub kami	
		230V AC	√	RXG12P7	155.000	2
2	5	24V DC	-	RXG21BD	124.500	2
		24V DC	√	RXG22BD	136.000	1
		230V AC	-	RXG21P7	Hub kami	
		230V AC	√	RXG22P7	190.000	1
Aplikasi Standard (pin pipih) <u>Tanpa</u> Tombol Tes Manual						
1	10	24V DC	√	RXG13BD	98.900	2
		230V AC	√	RXG13P7	Hub kami	2
2	5	24V DC	√	RXG23BD	117.500	2
		230V AC	√	RXG23P7	Hub kami	2

Catatan :

- Untuk tipe tegangan koil lainnya silakan menghubungi customer care center kami.
- Harga untuk coil selain **BD** dan **P7** ada kemungkinan berbeda dengan daftar harga di atas.

■ Soket

Terminal	Koneksi	Untuk tipe relay	Referensi	Harga (Rp) (Sebelum PPN)	SS
Terpisah	Screw Connector	RXG1●●●	RGZE1S35M	90.800	2
		RXG2●●●	RGZE1S48M	127.500	1

Catatan : Terminal terpisah antara koil dan kontak digunakan untuk menghindari kesalahan pengkabelan.



Scan untuk
Data Teknis



RSB●●●●●
+
Soket



Modul Proteksi
+
LED

Harmony Electromechanical Relay

Relay Interface RSB 8A & 16A

■ Panorama Produk RSB

Jumlah Kontak C/O	Arus (A)	Tegangan Koil	Referensi	Harga (Rp) (Sebelum PPN)	SS
Aplikasi Standard (pin pipih)					
1	16	24V DC	RSB1A160BD	81.600	2
1	16	220V AC	RSB1A160M7	163.500	2
2	8	24V DC	RSB2A080BD	85.900	1
2	8	220V AC	RSB2A080M7	171.500	2

Catatan :

- Untuk tegangan koil yang lainnya silakan menghubungi customer care center kami.
- Harga untuk coil selain **BD** dan **M7** ada kemungkinan berbeda dengan daftar harga di atas.

■ Soket

Terminal	Koneksi	Untuk tipe relay	Referensi	Harga (Rp) (Sebelum PPN)	SS
Terpisah	Screw Clamp	RSB1 dan RSB2	RSZE1S48M	102.000	2

Catatan :

- Terminal terpisah antara koil dan kontak digunakan untuk menghindari kesalahan pengkabelan.
- Untuk memakai soket **RSZE1S48M** dengan relay **RSB1A160**, antara terminal 11-21, 14-24 dan 12-22 harus di jumper.

■ Modul Proteksi

Deskripsi	Tegangan	Referensi	Harga (Rp) (Sebelum PPN)	SS
Modul Diode	6 ... 230 V DC	RZM040W	108.000	2
	24 ... 60 V AC	RZM041BN7	108.000	2
Modul RC	110 ... 240 V AC	RZM041FU7	87.500	2
	6 ... 24 V AC/DC	RZM031RB	74.000	2
Modul Diode + LED	24 ... 60 V AC/DC	RZM031BN	42.700	2
	110 ... 230 V AC/DC	RZM031FPD	70.200	2
Modul Varistor + LED	6 ... 24 V AC/DC	RZM021RB	83.200	2
	24 ... 60 V AC/DC	RZM021BN	95.100	2
	110 ... 230 V AC/DC	RZM021FP	89.700	2



Scan untuk
Data Teknis

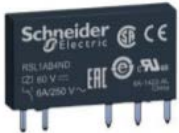

RSL1AB4ND



RSLZVA●

RSLZRA●

Harmony Electromechanical Relay

Super Slim Relay RSL 6mm

■ Slim Interface Relay

1 C/O kontak dan Thermal Current 6A

Control Circuit Voltage	Ref Standard	Harga (Rp) (Sebelum PPN)	SS
12VDC	RSL1AB4JD	79.400	2
24VDC	RSL1AB4BD	79.400	1
48VDC	RSL1AB4ED	81.000	2
60VDC	RSL1AB4ND	98.900	2

Catatan :

- Gantikan Kode **A** sebelum **B** menjadi **G** untuk Low Level Ref Standard Switching Current 10mA sedangkan untuk Low Level Switching Current 1mA

■ Soket

Dilengkapi dengan LED dan Protection Circuit.

Dijual per 10 pcs.

Operating Voltage	Untuk tipe relay	Tipe Socket Screw Connector Referensi	Harga (Rp) (Sebelum PPN)	SS
12VAC/DC	RSL1B4JD	RSLZVA1	187.000	1
24VAC/DC	RSL1B4BD			
40VAC/DC	RSL1B4ED	RSLZVA2	389.500	2
60VAC/DC	RSL1B4ND			
110VAC/DC	RSL1B4ND	RSLZVA3	187.000	2
230VAC/DC	RSL1B4ND	RSLZVA4	187.000	2

Catatan : Untuk Tipe Soket Spring Terminal gantikan **V** dengan **R**



Scan untuk
Data Teknis

Harmony Timer Relay

Harmony Timer Relay

adalah relay yang memberikan output berupa penundaan batas waktu setelah menerima input sinyal voltase atau switch terutama instalasi yang membutuhkan pengaturan waktu secara otomatis. Contoh aplikasinya adalah ON/OFF Delay

Harmony REXL miniature

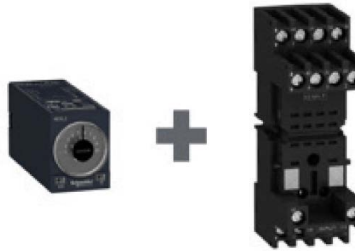

- Dipasang pada soket yang dapat langsung terpasang pada Din-rail.
- Desain yang ringkas (21 mm).
- Perangkat yang optimum, fungsi tunggal yang didedikasikan untuk aplikasi dasar dan sederhana.

Harmony RE 17/22



- Dipasang langsung pada Din-rail.
- Desain yang ringkas (17.5 / 22.5 mm) menghemat ruang.
- Fungsi tunggal/ ganda/ multi-fungsi (lebih dari 30 fungsi).



Scan untuk
Data Teknis



REXL2TM●●



RE17●●●●

Harmony Timer Relay

Miniature Plug In Timer REXL & RE17

■ Timer REXL

Waktu Tunda	Tipe	Jumlah C/O	Arus (A)	Referensi	Harga (Rp) (Sebelum PPN)	SS
0.1 detik s/d 100 jam	On Delay	4	3	REXL4TM●●	447.000	1
	On Delay	2	5	REXL2TM●●	488.500	1

Catatan : Gantikan kode ●● pada referensi untuk tegangan kontrol koil sesuai dengan tabel dibawah yang diikuti dengan Status Stock (SS) :

Koil	24V DC	24V AC	120V AC	230V AC
Kode ●●	BD (2)	B7 (2)	F7 (2)	P7 (1)

■ Soket

Terminal	Koneksi	Untuk tipe relay 12 V DC	Referensi	Harga (Rp) (Sebelum PPN)	SS
Tercampur	Screw clamp terminal	REXL2 / 4	RXZE2M114	57.300	1
	Screw connector	REXL2 / 4	RXZE2M114M	61.100	1
Terpisah	Screw connector	REXL2	RXZE2S108M	57.300	1
	Screw connector	REXL2 / 4	RXZE2S114M	64.800	1

Catatan : Terminal terpisah antara koil dan kontak digunakan untuk menghindari kesalahan pengkabelan.

■ Timer RE17 Solid State Output 0,7 A

Periode Waktu	Fungsi /Tipe	Tegangan	Referensi	Harga (Rp) (Sebelum PPN)	SS
1det- 100 jam	Tunggal	24-240 V AC/DC	RE17LAMW	562.000	1

■ Timer RE17 Relay Output 8 A

Periode Waktu	Fungsi /Tipe	Tegangan	Referensi	Harga (Rp) (Sebelum PPN)	SS
1det- 100 jam	Ganda	24VDC / 24-240 VAC	RE17RAMU	596.500	1
		24VDC / 24-240 VAC	RE17RHMU	617.000	2
	Multi	24VDC / 24-240 VAC	RE17RMMU	696.500	2
		12-240 V AC/DC	RE17RMMW	696.500	2

Catatan : Untuk kebutuhan produk timer lainnya (modular timing relay RE17, industrial timing relay RE22, dan universal timing relay RE48), silakan hubungi kami.



Scan untuk
Data Teknis



Dapat dipasang pada
Din rail 35mm dan
Screw fixing

Zelio Logic Smart Relay SR2 & SR3

Zelio Logic “Smart Relay” Generasi ke-2

Menawarkan solusi cerdas untuk sistem otomasi sederhana pada sektor industri dan building.

Terdiri dari 2 tipe



SR2 (Tipe Ringkas)

Tipe ringkas (tidak dapat di extend) dengan pilihan jumlah I/O : 10, 12 dan 20



SR3 (Tipe Modular)

Tipe modular (dapat di extend) dengan pilihan jumlah I/O 10, 26 dan dapat di extend dengan modul extension (maksimum 1 modul extension)

* Maksimum I/O yang dapat dirangkai pada SR3 adalah 40 I/O, tersedia juga modul untuk komunikasi berbasis Modbus dan Ethernet.

■ Pemrograman dapat dilakukan dengan 2 cara

1

Pada Smart Relay, dengan menggunakan tombol-tombol yg ada (khusus untuk smart relay dengan display).

2

Dengan software “**Harmony Soft**” (melalui komputer), terdapat 2 pilihan bahasa:
1. **LADDER**
2. **FDB** (Function Block Diagram).

Pemrograman dengan Harmony Soft memungkinkan anda untuk melakukan:

- ✓ **Simulasi**
- ✓ **Monitoring**
- ✓ **Supervisi**

Simulasi dapat dilakukan tanpa harus terkoneksi dengan smart relay.

■ Back up

Dilengkapi dengan Lithium battery untuk backup clock selama 10 tahun!
Parameter dan program disimpan dalam internal EEPROM Flash memory (10 tahun).

■ Fungsi-fungsi dalam Smart Relay

- 1 16 timer (dengan 11 pilihan tipe timer seperti: on delay, off delay, dll) dapat diset dari 1/10 detik hingga 9999 jam
- 2 16 up/down counter, dapat diset dari 0 hingga 32767
- 3 1 fast counter (1 kHz)
- 4 16 text function blocks
- 5 16 analog komparator function blocks
- 6 8 clock function blocks (weekly clock)
- 7 28 internal relay
- 8 8 counter comparator



SR2B121BD



SR2E121FU



SR2PACKBD

Zelio Logic Smart Relay SR2 & SR3

■ Tipe Ringkas dengan Display

Tegangan Suplai	I/O	Input Diskrit	Input Analog 0-10V	Output Relay	Output Transistor	Clock	Referensi	Harga (Rp) (Sebelum PPN)	SS
12VDC	12	8	4	4	0	ya	SR2B121JD	2.557.800	1
	20	12	6	8	0	ya	SR2B201JD	3.739.700	1
24VDC	10	6	0	4	0	tidak	SR2A101BD ⁽¹⁾	2.441.200	2
	12	8	4	4	0	ya	SR2B121BD	2.651.100	1
	12	8	4	0	4	ya	SR2B122BD	2.394.600	2
	20	12	2	8	0	tidak	SR2A201BD ⁽¹⁾	3.941.100	2
24VAC	20	12	6	8	0	ya	SR2B201BD	3.738.700	1
	20	12	6	0	8	ya	SR2B202BD	3.711.100	2
	12	8	0	4	0	ya	SR2B121B	3.123.900	2
100-240VAC	10	6	0	4	0	tidak	SR2A101FU ⁽¹⁾	2.429.600	2
	12	8	0	4	0	ya	SR2B121FU	2.725.300	1
	20	12	0	8	0	tidak	SR2A201FU ⁽¹⁾	3.614.600	2
	20	12	0	8	0	ya	SR2B201FU	3.945.400	1

■ Tipe Ringkas tanpa Display

Tegangan Suplai	I/O	Input Diskrit	Input Analog 0-10V	Output Relay	Output Transistor	Clock	Referensi	Harga (Rp) (Sebelum PPN)	SS
24 V DC	10	6	0	4	0	tidak	SR2D101BD ⁽¹⁾	1.930.300	2
	12	8	4	4	0	ya	SR2E121BD	2.514.400	2
	20	12	2	8	0	tidak	SR2D201BD ⁽¹⁾	3.621.000	2
	20	12	6	8	0	ya	SR2E201BD ⁽¹⁾	3.751.400	2
24 V AC	12	8	0	4	0	ya	SR2E121B	2.621.400	2
	10	6	0	4	0	tidak	SR2D101FU ⁽¹⁾	2.002.400	2
100-240 V AC	12	8	0	4	0	ya	SR2E121FU	2.286.500	2
	20	12	0	8	0	tidak	SR2D201FU ⁽¹⁾	3.087.800	2
	20	12	0	8	0	ya	SR2E201FU	3.605.100	2

■ Tipe Paket Ringkas

Tegangan Suplai	I/O	Deskripsi	Referensi	Harga (Rp) (Sebelum PPN)	SS
24 V DC	12	SR2B121BD, software, kabel koneksi	SR2PACKBD	3.711.100	2
	20	SR2B201BD, software, kabel koneksi	SR2PACK2BD	4.961.900	2
100-240 V AC	12	SR2B121FU, software, kabel koneksi	SR2PACKFU	3.782.100	1
	20	SR2B201FU, software, kabel koneksi	SR2PACK2FU	4.961.900	1

Catatan :

(1) Hanya dapat diprogram dalam bahasa LADDER.

Zelio Logic Smart Relay SR2 & SR3



SR3B261BD

■ Tipe Modular dengan Display

Tegangan Suplai	I/O	Input Diskrit	Input Analog 0-10V	Output Relay	Output Transistor	Clock	Referensi	Harga (Rp) (Sebelum PPN)	SS
24 V DC	10	6	4	4	0	ya	SR3B101BD	2.716.800	1
		6	4	0	4	ya	SR3B102BD	5.214.200	2
	26	16	6	10 ⁽¹⁾	0	ya	SR3B261BD	4.696.900	1
		16	6	0	10	ya	SR3B262BD	4.524.100	1
24 V AC	10	6	0	4	0	ya	SR3B101B	3.201.200	2
	26	16	0	10 ⁽¹⁾	0	ya	SR3B261B	4.519.900	2
100-240 V AC	10	6	0	4	0	ya	SR3B101FU	2.653.200	1
	26	16	0	10 ⁽¹⁾	0	ya	SR3B261FU	4.639.700	1



SR3XT141BD

■ Modul Extension I/O (2)

Tegangan Suplai	I/O	Input Diskrit	Input Analog	Output Relay	Output Analog	Referensi	Harga (Rp) (Sebelum PPN)	SS
24 V DC	6	4	-	2	-	SR3XT61BD	1.263.600	2
	10	6	-	4	-	SR3XT101BD	1.302.800	2
	14	8	-	6	-	SR3XT141BD	1.774.500	1
24 V AC	6	4	-	2	-	SR3XT61B	1.390.800	2
	10	6	-	4	-	SR3XT101B	1.340.900	2
100-240 V AC	6	4	-	2	-	SR3XT61FU	1.263.600	2
	10	6	-	4	-	SR3XT101FU	1.302.800	2
	14	8	-	6	-	SR3XT141FU	1.774.500	1
24 V DC	4	-	0-10V/0-20mA, Pt 100	6	0-10V	SR3XT43BD	3.087.800	1



SR3NET01BD

■ Modul Komunikasi

Untuk digunakan pada	Tegangan Suplai	Referensi	Harga (Rp) (Sebelum PPN)	SS
Jaringan Modbus	24 V DC	SR3MBU01BD	1.998.100	2
Jaringan Ethernet	24 V DC	SR3NET01BD	3.480.000	2
Interface Modem	12 - 24 V DC	SR2COM01	2.839.800	2
Modem GSM (+ kabel)	12 - 24 V DC	SR2MOD02	11.349.500	2



SR2PACKBD

■ Tipe Paket Modular

Tegangan Suplai	I/O	Deskripsi	Referensi	Harga (Rp) (Sebelum PPN)	SS
24 V DC	10	SR3B101BD, software, kabel koneksi	SR3PACKBD	3.534.100	2
	26	SR3B261BD, software, kabel koneksi	SR3PACK2BD	5.253.400	1
100-240 V AC	10	SR3B101FU, software, kabel koneksi	SR3PACKFU	4.777.500	2
	26	SR3B261FU, software, kabel koneksi	SR3PACK2FU	5.253.400	1

Catatan :

- (1) 8 output dengan arus total max 8A dan 2 output dengan arus max. 5A
 (2) Tegangan supply modul extension harus sama dengan smart relay.

■ Aksesori untuk SR2 dan SR3

Deskripsi	Referensi	Harga (Rp) (Sebelum PPN)	SS
EEPROM back up memory, firmware ≤ 2.4	SR2MEM01	1.302.800	2
EEPROM back up memory, firmware ≥ 3.0	SR2MEM02	628.600	2
Kabel koneksi /programming PC ke Harmony logic (3m) Serial port	SR2CBL01	1.727.800	2
Kabel koneksi /programming PC ke Harmony logic (3m) USB port	SR2USB01	2.084.000	1

Power Supply

Modicon ABL2

Panel Mounting 12 dan 24 VDC

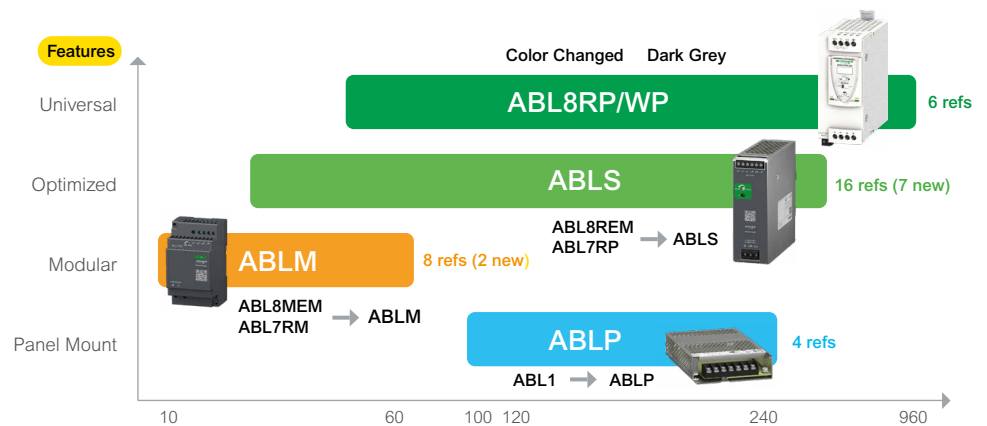

ABL2REM24020K

Phaseo ABL2 range

Tegangan Input V	Tegangan Output V DC	Daya Nominal (Watt)	Arus Nominal (A)	Voltage Switching	Referensi	Harga (Rp) (Sebelum PPN)	SS
AC 100...240 (1) single-phase wide range	24 VDC	35	1.5	Automatic	ABL2REM24015K	416.600	2
		50	2.2	Automatic	ABL2REM24020K	465.400	2
		100	4.5	Manual	ABL2REM24045K	611.700	2
AC 100...120 AC 200...240 (2) single-phase	24 VDC	150	6.5	Manual	ABL2REM24065K	691.200	2
		200	8.3	Manual	ABL2REM24085K	977.400	2
		250	10.5	Manual	ABL2REM24100K	1.118.300	2
		350	14.6	Manual	ABL2REM24150K	1.178.800	2



ABL2K01



ABL2K02

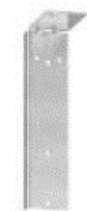

ABL2K03A



ABL2K03B

Mounting Aksesori untuk Phaseo ABL2●K

Deskripsi	Untuk Power Supply	Referensi	Harga (Rp) (Sebelum PPN)	SS	Min Order
Braket Instalasi empat pojokan	Direkomendasikan untuk Baut M4*6mm atau M4*8mm	ABL2K01	Hub kami	2	40
	ABL2REM24085K/100K/150K: tiap produk butuh 4	ABL2K02			
35MM Braket utk DIN Rail 35mm	ABL2REM24200K/250K/350K butuh 2			2	5
	Braket L kecil untuk ABL2REM24085K/100K/150K	ABL2K03A		2	1
	Braket L besar untuk ABL2REM24200K/250K/350K	ABL2K03B		2	1

Power Supply

Modicon ABLM & ABL8 & ABL8

DIN Rail Mounting

Regulated switching untuk power supply DC yang mempunyai keunggulan :

- Ukuran sangat ringkas, DIN Rail mounting
- Dilengkapi solusi dengan modul **Buffer, Baterai Back-up dan Redundancy**.
- Integrated proteksi terhadap: beban lebih, hubung singkat, tegangan lebih/kurang
- Range tegangan input sangat beragam, tanpa perlu konfigurasi
- Tegangan keluaran sangat stabil
- Performance tinggi
- Pilihan power supply ideal untuk Harmony Logic, Twido, M340, Premium dan Quantum

40%
Smaller!



ABLM1A24004



ABL8MEM12020

■ Modicon ABLM Modular Power Supply (replace ABL8MEM)

Tegangan Input (V)	Tegangan Output (V DC)	Daya Nominal (Watt)	Arus Nominal (A)	Reset after overload or short circuit	Output voltage adjustment potentiometer	Referensi	Harga (Rp) (Sebelum PPN)	SS
Single-phase (N-L1) atau phase-to-phase (L1-L2)								
100...240 V	5	18	3.6	Automatic	With	ABLM1A05036	1.338.800	2
		12	1	Automatic	Without	ABLM1A12010	888.300	2
	12	25	2.1	Automatic	With	ABLM1A12021	1.306.000	2
		50	4.17	Automatic	With	ABLM1A12042	1.894.300	2
	24	10	0.42	Automatic	Without	ABLM1A24004	779.100	2
		15	0.625	Automatic	Without	ABLM1A24006	874.500	2
		30	1.25	Automatic	With	ABLM1A24012	1.296.400	2
		60	2.5	Automatic	With	ABLM1A24025	1.879.400	2

■ Modicon ABL8 Optimized Power Supply (replace ABL8REM)

Tegangan Input (V)	Tegangan Output (V DC)	Daya Nominal (Watt)	Arus Nominal (A)	Reset after overload or short circuit	Output voltage adjustment potentiometer	Referensi	Harga (Rp) (Sebelum PPN)	SS
100...240 VAC 140...340 VDC (except ABLS1A24021 and ABLS1A24038)	12	75	6.25	Automatic	With	ABLS1A12062	2.052.200	2
		120	10	Automatic	With	ABLS1A12100	2.838.700	2
	24	50	2.1	Automatic	With	ABLS1A24021	1.703.500	2
		75	3.13	Automatic	With	ABLS1A24031	1.900.600	2
		91.2	3.8	Automatic	Without	ABLS1A24038	2.408.400	2
		120	5	Automatic	With	ABLS1A24050	2.662.800	2
	48	240	10	Automatic	With	ABLS1A24100	4.170.100	2
		480	20	Automatic	With	ABLS1A24200	7.164.600	2
		120	2.5	Automatic	With	ABLS1A48025	2.838.700	2

■ Modicon ABL8 Universal range

Tegangan Input (V)	Tegangan Output (V DC)	Daya Nominal (Watt)	Arus Nominal (A)	Reset	Referensi	Harga (Rp) (Sebelum PPN)	SS
Single-phase (N-L1) atau phase-to-phase (L1-L2)							
100...120 / 200...500 VAC	24	72	3	Auto/Manual	ABL8RPS24030	3.905.100	2
		120	5	Auto/Manual	ABL8RPS24050	4.604.700	1
		240	10	Auto/Manual	ABL8RPS24100	6.329.300	1
100...120 / 200...240 VAC	24	480	20	Auto/Manual	ABL8RPM24200	12.709.400	1
3 Phase (L1-L2-L3) 380...500 VAC	24	480	20	Auto/Manual	ABL8WPS24200	10.195.100	2



ABL8RPS24050



ABL8WPS24200



ABL8BBU24200
+
Baterai Back-up



ABL8DCC05060

Power Supply

Modular, Optimum, & Universal

■ Solusi dengan modul Buffer, Baterai Back-up dan Redundancy

Solusi Modul	Kapasitas Baterai (Ah)	Arus Nominal (A)	Reset	Referensi	Harga (Rp) (Sebelum PPN)	SS
Solusi dengan modul Baterai Back-up Control modul		20	-	ABL8BBU24200	8.419.600	2
	3.2	-	-	ABL8BPK24A03	6.790.400	2
Baterai	7	-	-	ABL8BPK24A07	8.894.500	2
	12	-	-	ABL8BPK24A12	12.883.300	2
EEPROM back up memory	-	-	-	SR2MEM02	628.600	2
Solusi dengan modul Redundancy	-	40	-	ABL8RED24400	3.009.400	2

■ DC to DC Converter

(hanya digunakan untuk Phaseo ABL8 Universal range)

Tegangan Input (V)	Tegangan Output (V DC)	Arus Output (A)	Arus Nominal (A)	Referensi	Harga (Rp) (Sebelum PPN)	SS
24 VDC	5 - 6.5	2.2	6	ABL8DCC05060	2.343.700	2
	7 - 15	1.7	2	ABL8DCC12020	2.343.700	2

EcoStruxure™ Automation Expert

EcoStruxure Automation Expert adalah terobosan dalam dunia industri otomasi, yaitu memanfaatkan keterbukaan sistem software tanpa melihat jenis hardware dan merek yang digunakan. Otomasi menjadi universal dan terbukti memberikan 100% efisiensi dalam desain program, 100% kegiatan operasional yang efektif dan sistem yang 100% berkelanjutan.

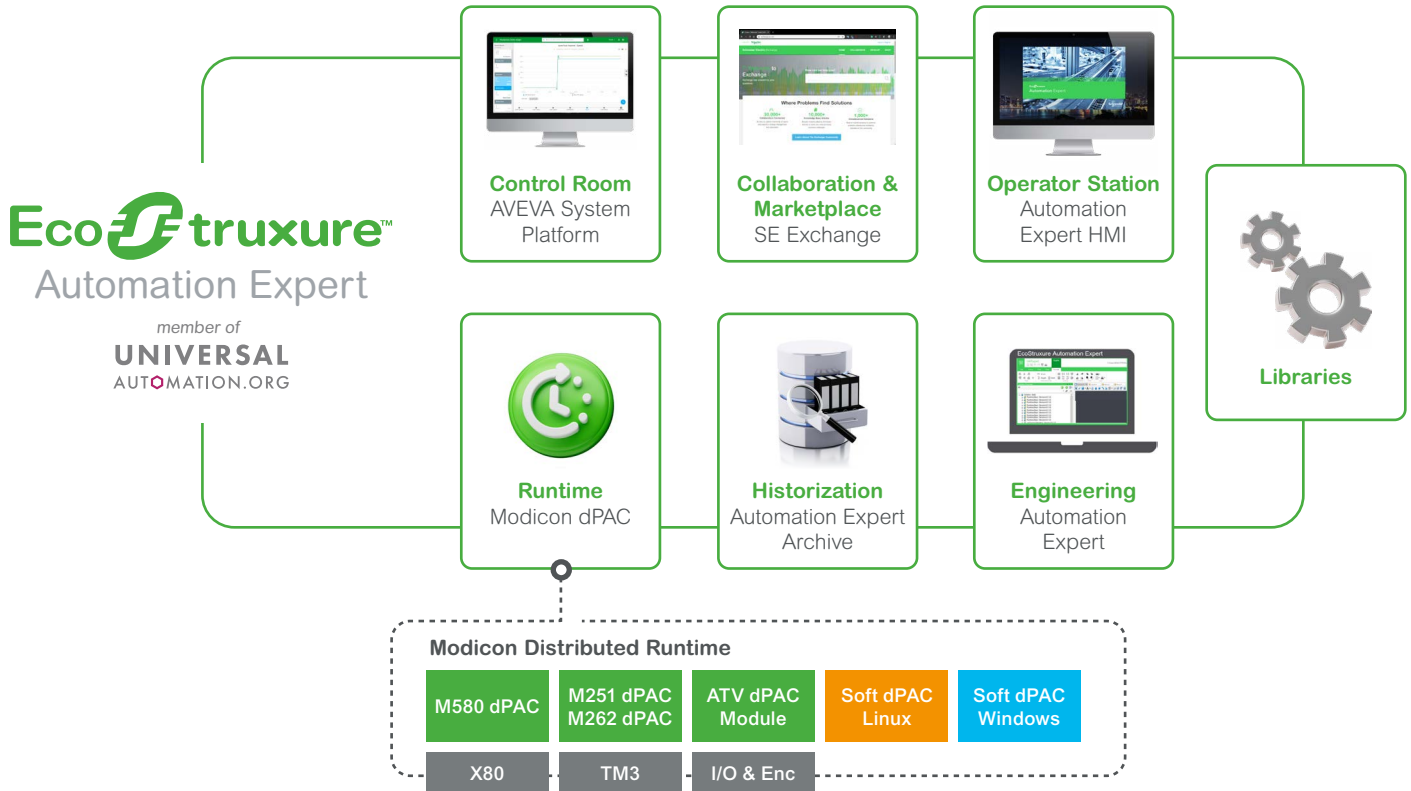

EcoStruxure Automation Expert adalah teknologi yang menyatukan teknologi software dan hardware dengan menggunakan standar baru, yaitu IEC61499.

- EcoStruxure Automation Expert *engineering, monitoring* dan manajemen sistem.
- Distributed Programmable Automation Controller (dPAC) platform yang fleksibel dan dapat disesuaikan dengan kebutuhan (*scalable*):
 - > **Schneider Electric hardware:**
 - ATV dPAC for Altivar
 - Modicon M251d and Modicon M262d with TM3 IO
 - Modicon M580d/X80 I/O
 - > **Innovative new software-based controllers:**
 - Soft dPAC for Linux™
 - Soft dPAC for Windows™
- EcoStruxure Automation Expert - HMI, sistem yang terintegrasi, berorientasi pada objek dan visualisasi yang memukau untuk industri.
- EcoStruxure Automation Expert - Archive, solusi terpusat untuk melakukan proses data, peringatan dan tren dari histori setiap aset.
- Schneider Electric Libraries, kumpulan solusi dan kode yang komprehensif, terdiri dari fungsi dasar hingga solusi khusus setiap segmen industri tanpa ada ketergantungan pada jenis hardware yang digunakan.

Note: UniversalAutomation.org (UAO) is an independent, not-for-profit association that will unleash innovation by decoupling application software from the hardware on which it executes. UAO manages the implementation of an industrial automation shared source runtime execution engine, based on the IEC 61499 standard. This new level of shared technology provides the basis for an ecosystem of portable, interoperable, "plug and produce" solutions and creates an entirely new category within industrial automation. UniversalAutomation.org is open to new members looking to advance the world of automation. See the UniversalAutomation.org website for more information.

Easy Harmony iPC Industrial PC, Edge Box dan Display

Easy Harmony HMIPSO *Optimized* Panel iPC dan HMIPSP *Performance* Panel iPC adalah rangkaian produk Easy Harmony iPC untuk aplikasi-aplikasi entry level

Rangkaian produk ini dibuat sedemikian sederhana namun disertai dengan CPU Intel® Celeron® 3855U dan Intel® Core™ i5-6200 yang sesuai untuk standar spesifikasi iPC di hampir semua aplikasi automasi di lapangan.

Fitur dan Benefit

Tepat guna & mudah digunakan

- LCD Backlight: 50.000 jam waktu hidup @ 25°C / 77°F
- Desain yang ringkas dan "all-in-one" hardware
- Pre-installed dengan EcoStruxure™ Machine SCADA Expert
- M.2 (mSATA) dan mini PCIe, memudahkan untuk penambahan ruang simpan data
- On-board memory dan mSATA SSD



Ketangguhan yang diadaptasikan dengan lingkungan

- Intel CPU tanpa kipas angin (fanless)
- Layar sentuh tipe single-touch
- Proteksi IP65
- Tingkat kekerasan 3H yang memberikan perlindungan anti-gores



Easy Harmony HMIPSO *Optimized*
15" and 15.6" Panel iPC



Easy Harmony HMIPSO *Performance*
15.6" and 18.5" Panel iPC

	Easy Harmony HMIPSO <i>Optimized</i>		Easy Harmony HMIPSP <i>Performance</i>	
	HMIPSOS742D1W01	HMIPSOS752D1W01	HMIPSPS752D1X01	HMIPSPS952D1X01
Tegangan Suplai	12...24 VDC (-15%/+20%) 2-pin power terminal			
Operating System	WES 7 Premium SP1 (64-bit multilingual)		Windows 10 IoT Enterprise LTSC (64-bit multilingual)	
Software	EcoStruxure Machine SCADA Expert			
Storage	mSATA SSD 128 GB			
CPU	Intel® Celeron® 3855U (1.6 GHz) tanpa kipas		Intel® Core™ i5-6200U (2.3 GHz) tanpa kipas	
RAM	4 GB DDR4, terpasang (non-expandable)		8 GB DDR4, terpasang (non-expandable)	
Port Koneksi	4x USB 3.0, 2x COM (RS-232/422/465), 2 Gigabit Ethernet		4x USB 3.0, 2x COM (RS-232/422/485), 2 Gigabit Ethernet	
Ukuran Layar	15"	15.6"	15.6"	18.5"
Harga (Rp) (Sebelum PPN)	49.618.600	55.164.600	74.946.300	80.494.300
SS	2	2	2	2

Harmony iPC HMIP6

Industrial PC, Edge Box dan Display



Harmony HMP6 Modular Box PCs



Harmony HMIDM6 Modular Displays

Harmony HMIP6 mengkoneksikan OT (Operational Technology) di lapangan ke IT (Information Technology) untuk Internet of Things (IoT) di industri.

Rangkain produk ini dibuat dengan konsep modular terdiri dari layar, SSD/HDD, opsi interface lengkap, dan port komunikasi standar industri.

Fitur dan Benefit

Tepat guna & mudah digunakan

- LCD Backlight: 50.000 jam waktu hidup @ 25°C / 77°F
- Desain yang ringkas dan "all-in-one" hardware
- Pre-installed dengan OS Windows 10 & EcoStruxure™ Machine SCADA
- M.2 (mSATA) dan mini PCIe, memudahkan untuk penambahan ruang simpan data
- On-board memory dan mSATA SSD

Ketangguhan yang diadaptasikan dengan lingkungan

- Intel CPU tanpa kipas angin (fanless) dan dengan kipas
- Layar sentuh tipe multi-touch
- Proteksi IP66F dan IP67F serta rating NEMA 4x
- Tingkat kekerasan 7H yang memberikan perlindungan anti-gores
- Sertifikasi All Models: CE, RCM, UL6110-201, CSA C22.2 No. 61010-20202, UL 121201 and CSA C22.2 No. 213

■ Harmony HMIP6 Modular Box PCs

Terdapat 2 jenis Modular Box, Advanced & Standard:

	Advanced	Standard
CPU	Intel Core/Celeron processor and UHD Graphics accelerator	
Operating System	Windows® 10 IoT Enterprise 2019 LTSC (64-bit)	
RAM	Up to 32 GB RAM	
Port Koneksi	USB Type A (2x USB 2.0 and 2x USB 3.0), USB Type C (1x USB 3.0), 1x COM RS-232C, 2x RJ45 Ethernet, 1x Display port USB Type C (1x USB 3.0), 1x COM RS-232C, 2x RJ45 Ethernet, 1x Display port	
Slot Ekspansi	1x PCI + 1x PCIe, 2x PCIe or 2x PCI	x
Storage	1x M.2 SSD SATA, 2x 2.5-inch SATA (HDD/SSD)	
Suplai Tegangan	2...24 Vc, 100...240 Va (HDD/SSD)	
Suplai Tambahan	Default TPM module for encryption	

■ Architecture:

Harmony HMIP6 Modular Displays kompatibel dan dengan mudah dipasangkan dengan Modular PC, pilihan yang luas, pengiriman yang cepat dan penggantian layar yang mudah.

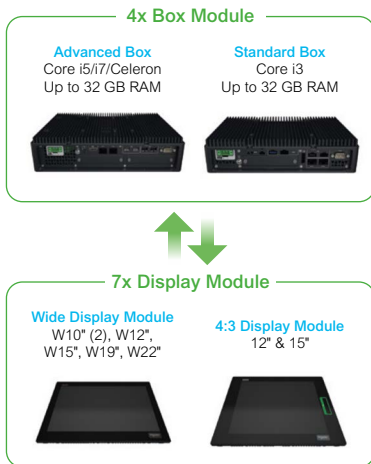

Produk konfigurator online:

Bagaimana cara konfigurasi Modular HMIP6 Box dan Display?

Ikuti langkah-langkah di bawah:

- 1 Kunjungi website di <https://www.se.com/id/en/product-range/22953172-harmony-p6>
- 2 Pilih Product Selector dan pilih CPUs, layar, power supply, storage options, memory, opsi interface, slot untuk ekspansi, sistem operasi dan software bila diperlukan.
- 3 Kode part number menunjukkan konfigurasi lengkap yang sudah dilakukan, setiap perubahan komponen yang dilakukan, kode part number akan berubah dst.
- 4 Klik **Add to Cart** atau kopi **Part Number** atau **Export for Ordering** (XML file)
- 5 Silahkan email part number atau file XML kepada Customer Care Center Schneider Indonesia untuk mendapatkan penawaran dan melanjutkan proses order

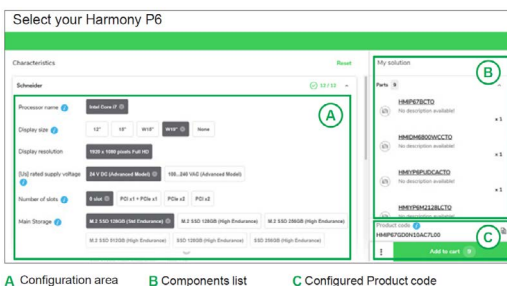



Vijeo Designer Basic

Easy Harmony ET6

Solusi HMI untuk aplikasi otomasi sederhana

Easy ET6 SIO (1) (2)

Ukuran Layar	Kapasitas Memory		Jumlah Port Komunikasi	Referensi	Harga (Rp) (Sebelum PPN)	SS
	Aplikasi	Backup				
7" wide, color TFT screen	256 MB	128 KB	1x COM2 (RS 422/485) 1x COM1 (RS-232C) 1 USB micro-B	HMIET6401	6.466.000	1
10" wide, color TFT screen	256 MB	128 KB	1x COM2 (RS 422/485) 1x COM1 (RS-232C) 1 USB micro-B	HMIET6501	11.213.700	1

Easy ET6 ETH (1) (2)

Ukuran Layar	Kapasitas Memory		Jumlah Port Komunikasi	Referensi	Harga (Rp) (Sebelum PPN)	SS
	Aplikasi	Backup				
7" wide, 800x480 pixels, color TFT Screen	256 MB	128 KB	1 COM1 (RS 232C), 1 COM2 (RS 422/485), 1 USB micro-B, 1 USB Type A, 1 10/100 Base-Tx	HMIET6400	7.104.200	1
10" wide, 1024x600 pixels, color TFT Screen	256 MB	128 KB	1 COM1 (RS 232C), 1 COM2 (RS 422/485), 1 USB micro-B, 1 USB Type A, 1 10/100 Base-Tx	HMIET6500	11.706.000	1
12" wide, 1280x800 pixels, color TFT Screen	256 MB	128 KB	1 COM1 (RS 232C), 1 COM2 (RS 422/485), 1 USB micro-B, 1 USB Type A, 1 10/100 Base-Tx	HMIET6600	17.246.200	1
15.6" wide, 1366x768 pixels, color TFT Screen	256 MB	128 KB	1 COM1 (RS 232C), 1 COM2 (RS 422/485), 1 USB micro-B, 1 USB Type A, 1 10/100 Base-Tx	HMIET6700	21.359.000	1

Software Konfigurasi

Deksripsi	Digunakan untuk	Referensi
Vijeo Designer Basic	Easy Harmony ET6	(3)

Catatan :

- (1) Panel disuplai lengkap dengan :
 - Terminal blok Screw.
 - Power Supply konektor.
- (2) Informasi komprehensif mengenai ET6 dapat dilihat di website Schneider Electric
- (3) Software Vijeo Designer Basic dapat di download di website Schneider Electric se.com/id

 Untuk permintaan dengan varian lainnya dapat menghubungi distributor

Easy Proface ET6000

Solusi HMI untuk aplikasi otomasi sederhana



Easy Proface ETH ⁽¹⁾ ⁽²⁾

Ukuran Layar	Kapasitas Memory		Jumlah Port Komunikasi	Referensi	Harga (Rp) <i>(Sebelum PPN)</i>	SS
	Aplikasi	Backup				
7" wide, 800x480 pixels, color TFT Screen	32 MB	128 KB	1 COM1 (RS 232C), 1 COM2 (RS 422/485), 1 USB micro-B, 1 USB Type A, 1 10/100 Base-Tx	PFXET6400WAD	7.104.200	1
10" wide, 1024x600 pixels, color TFT Screen	64 MB	128 KB	1 COM1 (RS 232C), 1 COM2 (RS 422/485), 1 USB micro-B, 1 USB Type A, 1 10/100 Base-Tx	PFXET6500WAD	11.706.000	1
12" wide, 1280x800 pixels, color TFT Screen	64 MB	128 KB	1 COM1 (RS 232C), 1 COM2 (RS 422/485), 1 USB micro-B, 1 USB Type A, 1 10/100 Base-Tx	PFXET6600WAD	17.246.200	1
15.6" wide, 1366x768 pixels, color TFT Screen	64 MB	128 KB	1 COM1 (RS 232C), 1 COM2 (RS 422/485), 1 USB micro-B, 1 USB Type A, 1 10/100 Base-Tx	PFXET6700WAD	21.359.000	1

Software Konfigurasi

Deksripsi	Digunakan untuk	Referensi
GP-Pro EX	Easy Proface ET6000	⁽³⁾

Catatan :

- ⁽¹⁾ Panel disuplai lengkap dengan :
 - Terminal blok Screw.
 - Power Supply konektor.
 - Instruction Sheet
- ⁽²⁾ Informasi comprehensive mengenai Proface ET6000 dapat dilihat di website Schneider Electric & Proface
- ⁽³⁾ Software GP-Pro EX dapat di download di website proface.com



Untuk permintaan dengan varian lainnya dapat menghubungi distributor

Modicon M221 PLC

Kinerja terbaik untuk ukurannya!

Modicon M221 logic Kontroler menawarkan kinerja terbaik di kelasnya. Hanya membutuhkan instalasi minimal dan menawarkan fleksibilitas yang luar biasa. Menghubungkan panel operator jarak jauh sederhana untuk perawatan cepat dan mesin visualisasi.

Tingkat fleksibilitas yang tinggi memungkinkan Anda menambahkan modul tambahan dengan mudah.

- Modul Safety
- TeSys SoLink motor starter
- Analog dan Digital modul yang ekstensif
- Lexium servo drive

Modicon M221

The small yet powerful logic controller for hardwired solutions.



- 1 2 Analog inputs
- 2 SD Card
- 3 USB Port
- 4 Run/Stop Switch
- 5 Serial line
- 6 Ethernet /Serial line

Fitur

- Embedded SD Card dan port USB
- 2 input analog dan pilihan I/O yang luas
- Run / stop switch dan ekstensi cartridge
- Ethernet dan port serial line

Pemrograman mesin intuitif dengan software EcoStruxure Machine Expert - Basic

- Navigasi sederhana memberikan proses rekayasa yang lebih efisien
- Semua pemrograman, visualisasi, dan commissioning ditangani dalam satu alat yang intuitif
- Tersedia gratis untuk di download
- Tidak ada pelatihan yang dibutuhkan

Modicon M221 logic Kontroler adalah EcoStruxure™ Machine kontroler

EcoStruxure™ Machine dari Schneider Electric merupakan solusi intuitif untuk otomatisasi mesin dengan semua fitur dan fungsi yang Anda butuhkan untuk membangun mesin yang akan meningkatkan bottom line. Dari desain dan pengembangan, untuk commissioning dan pemeliharaan.

EcoStruxure™ Machine adalah solusi mesin lengkap dengan manfaat sepanjang siklus hidup mesin.

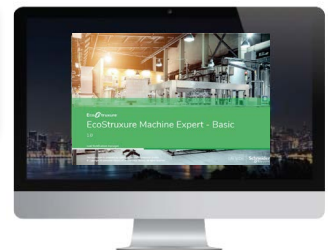

Modicon M221

Logic Kontroler & Book Logic Kontroler



TM221C24R



TM221CE24T

■ Modicon M221 Logic Kontroler ⁽¹⁾

Jumlah Logic I/O	Logic Input	Logic Output	Analog Input	Port Komunikasi yang terintegrasi ⁽²⁾		Referensi	Harga (Rp) (Sebelum PPN)	SS
				Ethernet (RJ45)	Serial Link (RJ45)			
100-240VAC power supply								
16 I/O	9 Sink/Source 24 VDC Input Inc. 4 High-Speed Input	7 Relay Output	2 x 0..10V Input	-	1	TM221C16R	5.565.000	2
				1	1	TM221CE16R	6.231.800	1
24 I/O	14 Sink/Source 24 VDC Input Inc. 4 High-Speed Input	10 Relay Output	2 x 0..10V Input	-	1	TM221C24R	6.903.800	2
				1	1	TM221CE24R	7.420.000	1
40 I/O	24 Sink/Source 24 VDC Input Inc. 4 High-Speed Input	16 Relay Output	2 x 0..10V Input	-	1	TM221C40R	8.903.000	2
				1	1	TM221CE40R	9.645.000	1
24VDC power supply								
16 I/O	9 Sink/Source 24 VDC Input Inc. 4 High-Speed Input	7 Source Transistor Output, Inc. 2 High-Speed Output	2 x 0..10V Input	-	1	TM221C16T	5.565.000	2
				1	1	TM221CE16T	5.763.300	1
24 I/O	14 Sink/Source 24 VDC Input Inc. 4 High-Speed Input	10 Source Transistor Output, Inc. 2 High-Speed Output	2 x 0..10V Input	-	1	TM221C24T	6.678.000	2
				1	1	TM221CE24T	7.420.000	1
40 I/O	24 Sink/Source 24 VDC Input Inc. 4 High-Speed Input	16 Source Transistor Output, Inc. 2 High-Speed Output	2 x 0..10V Input	1	1	TM221CE40T	9.645.000	1



TM221ME16RG

■ Modicon M221 Book Logic Kontroler ⁽³⁾

Jumlah Logic I/O	Logic Input	Logic Output	Analog Input	Port Komunikasi yang terintegrasi ⁽⁴⁾			Terminal Block	Referensi	Harga (Rp) (Sebelum PPN)	SS
				Ethernet (RJ45)	Serial Link					
					SL1 (RJ45)	SL2 (RJ45)				
24VDC power supply										
16 I/O	8 Sink/ Source 24 VDC Input Inc. 4 High-Speed Input	8 Relay Output	2 x 0..10V Input	-	1	1	Screw	TM221M16R	6.677.000	2
				-	1	1	Spring	TM221M16RG	6.097.200	2
				1	1	-	Screw	TM221ME16R	6.777.700	1
				1	1	-	Spring	TM221ME16RG	6.777.700	2
		8 Source Transistor Ouput, Inc. 2 High-Speed Output	2 x 0..10V Input	-	1	1	Screw	TM221M16T	6.677.000	2
				1	1	-	Screw	TM221ME16T	7.331.000	2
				1	1	-	Spring	TM221ME16TG	6.777.700	2
				-	-	-	-	-	-	-
32 I/O	16 Sink/ Source 24 VDC Input Inc. 4 High-Speed Input	16 Source Transistor Ouput, Inc. 2 High-Speed Output	2 x 0..10V Input	-	1	1	Konektor HE 10	TM221M32TK	7.417.900	2
				1	1	-	Konektor HE 10	TM221ME32TK	8.161.000	2

Catatan :

- (1) M221 Kontroler disuplai lengkap dengan :
 - Terminal blok screw yang dapat di lepas untuk konektor IO
 - Terminal blok screw yang dapat di lepas untuk konektor power supply
 - Baterai cadangan tipe button (BR2032)
 - Kabel untuk koneksi dengan analog input
- (2) Setiap M221 Logic Kontroler mempunyai Embedded USB Mini-B port untuk programming
- (3) M221 Book Kontroler disuplai lengkap dengan :
 - Terminal blok (screw / spring sesuai dengan tipe Kontroler) yang dapat di lepas untuk konektor IO
 - Terminal blok screw yang dapat di lepas untuk konektor power supply
 - Baterai cadangan tipe button (BR2032)
 - Kabel untuk koneksi dengan analog input
- (4) Setiap M221 Book Logic Kontroler mempunyai Embedded USB Mini-B port untuk programming

i Untuk permintaan dengan varian lainnya dapat menghubungi distributor.

Software Installer dapat di unduh pada website se.com/id

Modicon M241

Modicon untuk Aplikasi Performa Tinggi

Merupakan ComPact machine dengan performa tinggi menggunakan kecepatan dan fungsi kontrol posisi yang sesuai dengan kebutuhan anda. Dapat dengan mudah diintegrasikan dengan arsitektur sistem kontrol untuk memonitor mesin jarak jauh. Maintenance dapat dilakukan melalui aplikasi smartphone, tablet, dan PC.

Fitur

- Embedded Ethernet port menyediakan : FTP (Client/ Server), Web Server, dan SQL (Client) Services.
- Function embedded di kontroler : Modbus Serial, dedicated USB programming port, Ethernet I/O scanner, CANopen, SAE J1939 fieldbus untuk arsitektur terdistribusi, advanced position control functions.
- Processing power dan memori dengan kapasitas tinggi : Execution Speed (22 ns/ Boolean), DualCore Processor, Program size (10 MB untuk aplikasi dan simbol), RAM 64 MB, Flash Memory 128 MB.
- Dapat diprogram dengan mudah menggunakan software So Machine.



Keunggulan M241

- Mampu meminimalisasi biaya mesin anda dengan fitur yang tersedia. Sesuai untuk aplikasi dengan performa tinggi.
- Aplikasi yang sudah ada dapat diperoleh dari M221, M238, dan M258 sehingga dapat melindungi investasi yang sudah ada sebelumnya.

Programming menggunakan software EcoStruxure™ Machine Expert

merupakan proses pemrograman yang intuitif dan cepat untuk membentuk aplikasi.





TM241C24R



TM241C40R



TM241CE24R



TM241CE40T



TM241CE40U



TM241CEC34U

■ Modicon M241 Logic Kontroler ⁽¹⁾

Jumlah Logic I/O	Logic Input	Logic Output	Port Komunikasi yang terintegrasi			Berat (kg)	Referensi	Harga (Rp) (Sebelum PPN)	SS
			Ethernet (RJ45)	CANopen (Screw terminal): CANopen/SAEJ1939	Serial Link (RJ45 & Screw Terminal)				
100-240VAC power supply									
24 I/O	14 sink/source 24 VDC inputs, inc. 8 high-speed inputs	10 outputs : inc. 4 source transistor high-speed outputs and 6 relay outputs	-	-	1+1	0,530	TM241C24R	10.995.400	2
			1	-	1+1	0,530	TM241CE24R	11.708.800	2
			1	1	1+1	0,530	TM241CEC24R	15.164.400	2
40 I/O	24 x 24 VDC inputs, inc. 8 high-speed inputs	16 outputs: inc. 4 source transistor high-speed outputs and 12 relay outputs	-	-	1+1	0,620	TM241C40R	12.161.400	2
			1	-	1+1	0,620	TM241CE40R	11.650.500	1
24VDC power supply									
24 I/O	14 sink/source 24 VDC inputs, inc. 8 high-speed inputs	10 source transistor output, inc. 4 high-speed output	1	1	1+1	0,530	TM241CEC24T	10.937.100	2
			1	-	1+1	0,530	TM241CE24T	10.808.900	2
40 I/O	24 sink/source 24 VDC inout, inc. 8 high-speed input	16 source transistor output, inc. 4 high-speed output	1	-	1+1	0,620	TM241CE40T	11.576.300	2
			1	-	1+1	0,620	TM241CE40U	11.551.900	2

Catatan :

(1) Modul kontroler M241 tersedia dengan :

- Removable terminal block (screw terminal) untuk menghubungkan I/O dengan ulir 3,81 mm (0,15 in)
- Removable terminal block untuk menghubungkan power supply dengan ulir 5,08 mm (0,2 in)
- Backup baterai button cell (BR2032) • Terminal blok screw yang dapat di lepas untuk

■ Programming Software untuk M241
EcoStruxure Machine Expert

Bentuk Lisensi	Deskripsi	Referensi	Harga (Rp) (Sebelum PPN)	SS
Lisensi tanpa material fisik - Digital*	EcoStruxure Machine Expert - Standard - Single (1) License	ESEEXPCZZSPAZZ	9.601.500	2

Catatan :

- *) Lisensi tanpa material fisik mempunyai waktu delivery yang lebih cepat di bandingkan lisensi dengan material fisik.
- Software Installer dapat di unduh pada website se.com/id



Modicon M251

Solusi inovatif dengan performa tinggi di bidang modular machines dan distributed architecture.

- Dengan dimensi yang Compact, Modicon M251 mampu mengoptimalkan ukuran sistem kontrol yang berdiri maupun terpasang pada dinding di dalam ruang tertutup.
- M251 Logic Kontroler tidak memiliki embedded I/O sehingga field devices seperti variable speed drive dan remote I/O disambungkan dengan CANopen atau SAE J1939 machine bus atau melalui ethernet.

Fitur

- Embedded Ethernet port menyediakan : FTP (Client/ Server), Web Server, dan SQL (Client) Services.
- Function embedded di kontroler : Modbus Serial, dedicated USB programming port, Ethernet I/O scanner, CANopen, SAE J1939 fieldbus untuk arsitektur terdistribusi, advanced position control functions (PLC Open Library).
- Function embedded di Modicon TM3 Extension : functional safety module, motor-starter control module, dan remote expansion system
- Processing power dan kapasitas memori M251 sangat ideal untuk aplikasi dengan performa tinggi.
- Dapat diprogram dengan software SoMachine

Programming menggunakan software EcoStruxure™ Machine Expert

merupakan proses pemrograman yang intuitif dan cepat untuk membentuk aplikasi.



TM251MESC

TM251MESE

Processing Power

- Execution speed : 22ns/Boolean instruction
- Program : 128 Boolean Konstruktion
- DualCore processor
- 64 MB RAM : 128 MB Flash Memory
- Program size : 10 MB untuk aplikasi dan simbol

Embedded Communication

Modicon M251 memiliki 5 embedded communication ports :

- **TM251MESE :**
 - (1) Ethernet untuk komunikasi mesin dan jaringan pabrik
 - (2) Ethernet untuk menghubungkan field device (VSD, distributed I/O, dll) dan dapat dihubungkan dengan jaringan pabrik
- **TM251MESC :**
 - (1) Ethernet untuk komunikasi antara mesin dan jaringan pabrik
 - (2) CANopen untuk menghubungkan field device (VSD, distributed I/O)
- **Serial link port**
- **Programming port**

Modicon M251 Logic Kontroler



TM251MESC



TM251MESE

■ Modicon M251 Logic Kontroler ⁽¹⁾

Deskripsi	Port Komunikasi yang terintegrasi ⁽²⁾				Berat (kg)	Referensi	Harga (Rp) (Sebelum PPN)	SS
	Ethernet 1 "Mesin" atau "Pabrik" (RJ45)	Ethernet 2 "Fieldbus" (RJ45)	CANopen (9-way SUBD): CAN-open/SAE J1939	Serial Link (RJ45 & Screw Terminal)				
24 VDC power supply								
M251 Logic Kontroler	2 (terhubung dengan 1 switch)	-	1	1	0,220	TM251MESE	16.527.600	1
	2 (terhubung dengan 1 switch)	1	1	1	0,220	TM251MESC	16.676.000	2

■ Opsi untuk Modicon M251 Logic Kontroler

Nama	Deskripsi	Berat (kg)	Referensi	Harga (Rp) (Sebelum PPN)	SS
Industrial SD memory card	Backup aplikasi dan transfer program (Kapasitas : 256 MB)	0,004	TMASD1	1.239.200	2

■ Komponen Pengganti

Nama	Deskripsi	Berat (kg)	Referensi	Harga (Rp) (Sebelum PPN)	SS
Terminal block untuk menghubungkan modicon dengan power supply	8 removable screw terminal block	0,127	TMAT2PSET	848.000	2

Catatan :

- (1) M251 kontroler disuplai dengan :
 - Removable screw terminal block untuk menghubungkan modicon dengan power supply
 - BR2032 baterai button cell cadangan
- (2) Masing-masing M251 logic kontroler memiliki embedded USB mini-B programming port
- (3) Kabel undhielded dan non-grounded. Untuk koneksi sementara saja. Untuk koneksi permanen, gunakan kabel referensi BMXXCAUSBH018

■ Programming Software untuk M251 EcoStruxure Machine Expert

Bentuk Lisensi	Deskripsi	Referensi	Harga (Rp) (Sebelum PPN)	SS
Lisensi tanpa material fisik - Digital *	EcoStruxure Machine Expert - Standard - Single (1) License	ESEEXPCZZSPAZZ	9.601.500	2

Catatan :

- *) Lisensi tanpa material fisik mempunyai waktu delivery yang lebih cepat di bandingkan lisensi dengan material fisik.
- Software Installer dapat di unduh pada website se.com/id



Modicon M262

IIoT-ready logic/kontroler gerak untuk mesin industri

- Protokol cloud yang sudah terintegrasi termasuk MQTT, OPC UA Server and Client, API, and TLS encryption.
- Kontroler ini dengan mudah dapat terkoneksi dengan jaringan dan mengirim data ke Ecostruxure software dengan keamanan cybersecurity yang terjamin
- Performa terbaik dengan dual-core prosesor CPU

Komunikasi Opsional

Komunikasi bus pintar yang bisa ditambahkan:

- Hingga 3 komunikasi ethernet* yang terpisah menggunakan TMSES4
- Satu CANopen master (TMSC01)

*) 1 = TM262M05MESS8T

Local, remote and distributed I/O

Modul lokal (reguler & safety) dengan sistem TM3 I/O

- 7 modul lokal
- 7 modul remote (menggunakan transmitter/receiver)



Fitur

- Eth1 di 100 Mbit/s
- Eth2 di 1 Gbit/s, kompatibel dengan daisy chain and RSTP
- Ethernet services available on those networks include MQTTs*, TLS, OPC UA, HTTPs method (API)*, DHCP, FTPs, SNTP, SNMP, NTP.
- One serial line, RS232, RS485 with Modbus, ASCII, and EcoStruxure Machine Expert protocols
- 1 mini USB-B as a programming port and a local virtual port for FTP, HTTP, or Modbus
- SD card slot, up to 32 GB with SDHC
- 8 fast I/Os
 - 4 fast inputs allowing events in less than 20 μ s
 - 4 fast outputs switchable in less than 3 μ s
- QR code with the unique serial number and link to a webpage about M262 maintenance
- Run/stop switch

Programming menggunakan software EcoStruxure™ Machine Expert

merupakan proses pemrograman yang intuitif dan cepat untuk membentuk aplikasi.



Modicon M262

Logic Kontroler/ Kontroler Gerak



TM262L10MESE8T



TM262M15MESS8T



EcoStruxure Machine Expert

■ Modicon M262 Logic Kontroler ⁽¹⁾

Deskripsi	Execution Speed ns/ Boolean instructions	Max. no. of synchronized axes	Ethernet	Sercos	Serial Link	Berat (kg)	Referensi	Harga (Rp) (Sebelum PPN)	SS
24 VDC power supply									
M262 Logic Kontroler	5	-	2	-	1	0,665	TM262L10MESE8T	21.178.800	
M262 Kontroler Gerak	5	4 axes	2	1	1	0,670	TM262M15MESS8T	35.857.700	

■ Opsi untuk Modicon M262 Logic Kontroler

Nama	Deskripsi	Berat (kg)	Referensi	Harga (Rp) (Sebelum PPN)	SS
Ethernet Smart communication module	To add an Ethernet network Equipped with 4x RJ45 switched ports (IIoT-ready, Network isolation, Ethernet Gigabyte exchange)	0,403	TMSES4	9.765.800	
CANopen Smart communication module	To add a CANopen master network Equipped with a Sub-D9 connector	0,150	TMSCO1	4.955.500	

Catatan :

- (1) M251 kontroler disuplai dengan :
 - Removable screw terminal block untuk menghubungkan modicon dengan power supply
 - BR2032 baterai button cell cadangan
- (2) Masing-masing M251 logic kontroler memiliki embedded USB mini-B programming port
- (3) Kabel unshielded dan non-grounded. Untuk koneksi sementara saja. Untuk, koneksi permanen, gunakan kabel referensi BMXXCAUSBH018

■ Programming Software untuk M251 EcoStruxure Machine Expert

Bentuk Lisensi	Deskripsi	Referensi	Harga (Rp) (Sebelum PPN)	SS
Lisensi tanpa material fisik - Digital *)	EcoStruxure Machine Expert - Standard - Single (1) License	ESEEXPCZZSPAZZ	9.601.500	

Catatan :

- *) Lisensi tanpa material fisik mempunyai waktu delivery yang lebih cepat di bandingkan lisensi dengan material fisik.
- Software Installer dapat di unduh pada website se.com/id

Modicon TM3 Expansion Module

Modicon TM3

Menyediakan kesempatan untuk mengembangkan kemampuan M221, M241, dan M251 logic kontroler.



Digital I/O



Analog I/O



Expert I/O Module



Bus Expansion Module



Functional Safety Module

■ Gambaran Umum TM3

- Digital I/O dapat digunakan untuk mengkonfigurasi hingga 488 I/O.
- Analog I/O dapat digunakan untuk mengkonfigurasi hingga 144 I/O, dirancang untuk menerima sinyal sensor posisi temperatur atau kecepatan. Mampu mengendalikan Variable Speed Drive (VSD) atau perangkat apapun yang memiliki arus atau input voltase.
- Expert Module untuk pengendalian TeSys motor starter yang menyederhanakan wiring dari bagian kontrol.
- Functional Safety Module bersifat fleksibel karena mampu mengakses lokasi perangkat jarak jauh dengan maksimum 5 meter.

■ Fitur Khusus

- Memiliki mekanisme perakitan interlocking yang sederhana.
- Bus Expansion connector digunakan untuk mendistribusikan data dan power suplai saat perakitan modicon TM3 expansion module dengan logic kontroler.



TM3DI8 TM3DI8G



TM3DI8A TM3DI32K



TM3DQ16UK



TM3DQ32TK TM3DQ32UK



TM3DM24R TM3DM24RG

Modicon TM3 digital I/O modul Expansion Module

Modicon TM3 Digital Input Modul

Jumlah Logic Input	Input Type	Terminal Block untuk Koneksi Input	Berat (kg)	Referensi	Harga (Rp) (Sebelum PPN)	SS
8 Input	Sink/source 24 VDC	Screw 5,08 mm	0,110	TM3DI8	2.649.000	1
		spring 5,08 mm	0,095	TM3DI8G	2.649.000	2
	120 VAC	Screw 5,08 mm	0,110	TM3DI8A	2.481.500	2
16 Input	Sink/source 24 VDC	Screw 3,81mm	0,105	TM3DI16	3.744.000	1
		Spring 3,81 mm	0,095	TM3DI16G	3.744.000	2
32 Input	Sink/source 24 VDC	HE 10 konektor	0,075	TM3DI16K	3.021.000	2
		HE 10 konektor	0,110	TM3DI32K	5.274.600	1

Modicon TM3 Digital Output Modul

Jumlah Logic Input	Output Type	Input Type	Terminal Block untuk Koneksi Input	Berat (kg)	Referensi	Harga (Rp) (Sebelum PPN)	SS
8 Output	Relay	2A	Screw 5,08 mm	0,130	TM3DQ8R	2.927.800	1
	Transistor, sumber	0,5A	Screw 5,08 mm	0,110	TM3DQ8T	2.515.400	2
	Transistor, sink	0,5A	Screw 5,08 mm	0,110	TM3DQ8U	2.481.500	2
16 Output	Relay	2A	Screw 3,81mm	0,140	TM3DQ16R	3.943.200	1
			Spring 3,81 mm	0,130	TM3DQ16RG	3.943.200	2
	Transistor, sumber	0,5A	Screw 3,81 mm	0,105	TM3DQ16T	3.585.000	2
			Spring 3,81 mm	0,095	TM3DQ16TG	3.585.000	2
			Screw 3,81 mm	0,105	TM3DQ16U	3.509.700	2

Modicon TM3 Digital Input Output Modul

Jumlah Logic Input	Jumlah & Tipe Input	Jumlah & Tipe Output	Terminal Block untuk Koneksi Input	Berat (kg)	Referensi	Harga (Rp) (Sebelum PPN)	SS
8 Input/ Output	4 sink/source 24 VDC input	4 relay output, 2A	Screw 5,08mm	0,120	TM3DM8R	2.776.200	2
			Spring 5,08 mm	0,100	TM3DM8RG	2.776.200	2
24 Input/ Output	16 sink/source 24 VDC input	8 relay output, 2A	Spring 3,81 mm	0,155	TM3DM24RG	4.939.600	2

Catatan :

- Modicon TM3 sudah disuplai dengan removable terminal block tipe screw atau spring
- Modul compatible digunakan dengan sistem pre-wired Telefast Modicon ABE7

Modicon TM3 Analog I/O modul

Expansion Module



TM3AI2H TM3AI4



TM3TI4 TM3AI8



TM3TI8T



TM3AQ2 TM3AQ4



TM3TM3 TM3AM6

Jumlah & tipe channel	Input range	Output range	Resolusi	Terminal Block untuk Koneksi Input	Berat (kg)	Referensi	Harga (Rp) (Sebelum PPN)	SS
Modicon TM3 Analog Input Modul								
2 Voltage/ current input	-10...+ 10 VDC, 0...+ 10VDC/0...20 mA, 4...20mA	-	16 bit atau 15 bit + sign	Screw 5,08 mm	0,115	TM3AI2H	3.799.100	2
				Spring 5,08 mm	0,100	TM3AI2HG	3.799.100	2
4 Voltage/ current input	-10...+ 10 VDC; 0...+ 10 VDC/0...20 mA, 4...20mA	-	12 bit atau 11 bit + sign	Screw 3,81 mm	0,110	TM3AI4	4.228.400	1
				Spring 3,81 mm	0,100	TM3AI4G	4.228.400	2
4 Temperatur atau voltage/ current input ⁽²⁾	1. Termokopel (J,K,R,S,B,T,N,E,C) 2. Temperature probe (RTD)(Ni100, Ni1000, PT100, PT1000) 3. -10...+10VDC, 0...+10 VDC/0...20mA, 4...20mA	-	16 bit atau 15 bit + sign	Screw 3,81 mm	0,110	TM3TI4	4.930.100	1
				Spring 3,81mm	0,100	TM3AI8G	4.858.000	2
8 voltage/ current input	-10...+ 10 VDC, 0...+ 10VDC/0...20 mA, 4...20 mA	-	12 bit atau 11 bit + sign	Screw 3,81 mm	0,110	TM3AI8	4.858.000	1
				Spring 3,81mm	0,100	TM3AI8G	4.858.000	2
8 temperatur input	1. Termokopel (J,K,R,S,B,T,N,E,C) 2. Thermistor NTC & PTC	-	16 bit atau 15 bit + sign	Screw 3,81 mm	0,110	TM3TI8T	5.311.700	2
				Modicon TM3 Analog Output Modul				
2 Voltage/ current input	-	-10...+ 10 VDC, 0...+ 10VDC/0...20 mA, 4...20 mA	12 bit atau 11 bit + sign	Screw 5,08 mm	0,115	TM3AQ2	4.383.100	1
				Spring 5,08 mm	0,100	TM3AQ2G	4.383.100	2
4 Voltage/ current input	-	-10...+ 10 VDC, 0...+ 10VDC/0...20 mA, 4...20 mA	12 bit atau 11 bit + sign	Screw 5,08 mm	0,115	TM3AQ4	5.845.900	1
				Modicon TM3 Analog Input Output modul				
2 temperature atau voltage/ current input ⁽²⁾ dan 1 voltage/ current output	1. Termokopel (J,K,R,S,B,T,N,E,C) 2. Temperature probe (RTD)(Ni100, Ni1000, PT100, PT1000) 3. -10...+10VDC, 0...+10 VDC/0...20mA, 4...20mA	-10...+ 10 VDC, 0...+ 10VDC/0...20 mA, 4...20 mA	16 bit atau 15 bit + sign (untuk E)	Screw 5,08 mm	0,115	TM3TM3	5.181.300	2
				4 voltage/ current input dan 2 voltage current/output	-10...+10VDC, 0...+10VDC/0...20 mA, 4...20 mA	-10...+ 10 VDC, 0...+ 10VDC/0...20 mA, 4...20 mA	12 bit atau 11 bit + sign (untuk I & O)	Screw 3,81 mm
Spring 3,81 mm	0,100	TM3AM6G	5.487.700					2

Catatan :

(1) Modicon TM3 sudah disuplai dengan removable terminal block

(2) Masing-masing input dapat dikonfigurasi secara independen untuk temperatur atau voltase/aru

(3) Hanya untuk termokopel yang diisolasi

Modicon TM3 Functional Safety Modul Expansion Module



TM3SAF5R TM3SAF5RG



TM3SAK6R TM3SAK6RG

■ Modicon TM3 Digital Input Modul

Nama	Maksimum Level Keamanan yang Mampu Dicapai	Terminal Block untuk Koneksi Input	Berat (kg)	Referensi	Harga (Rp) (Sebelum PPN)	SS
24 VDC Power Supply						
Functional Safety Modul untuk pengendalian : 1. Emergency Stop 2. Switch	PL d/Kategori 3 sesuai dengan EN/ISO 13849-1 SILCL2 sesuai dengan EN/IEC 62061	Screw	0,190	TM3SAC5R	11.500.000	2
		Spring	0,190	TM3SAC5RG	11.500.000	2
Functional Safety Modul untuk pengendalian : 1. Emergency Stop 2. Switch 3. Safety light curtain dengan solid-state output 4. Mat atau ujung yang sensitif dengan tekanan	PL e/Kategori 4 sesuai dengan EN/ISO 13849-1 SILCL2 sesuai dengan EN/IEC 62061	Screw	0,190	TM3SAK6R	11.262.500	2
		Spring	0,190	TM3SAK6RG	11.262.500	2

Catatan :

(1) Bergantung pada model.

(2) Removable terminal block dilengkapi dengan screw terminal atau spring terminal dan safety modul.



TM3XTRA1



TM3XREC1

Modicon TM3 bus Expansion System Expansion Module

■ Modicon TM3 bus expansion system

Nama	Karakteristik	Berat (kg)	Referensi	Harga (Rp) (Sebelum PPN)	SS
Modul Transmitter	Modul transmisi data Power Supply : menggunakan TM3 bus	0,065	TM3XTRA1	2.148.700	1
Modul receiver	Modul penerimaan data Power Supply : 24 VDC (dengan power supply eksternal)	0,075	TM3XREC1 ⁽¹⁾	2.640.500	2

■ Aksesori untuk modul transmitter

Nama	Karakteristik	Panjang	Berat (kg)	Referensi	Harga (Rp) (Sebelum PPN)	SS
Functional ground cable	Kabel ground untuk TM3XTRA1 modul transmitter	0,12	-	TM3XTRA1 ⁽²⁾		

■ Spare part

Nama	Kegunaan	Berat (kg)	Referensi	Harga (Rp) (Sebelum PPN)	SS
Terminal Block untuk menghubungkan unit ke power supply	8 removable terminal block dengan screw terminal	0,127	TMAT2PSET	848.000	2

Catatan :

(1) Modul **TM3XREC1** dilengkapi dengan removable screw terminal block untuk menyambungkan unit ke power supply.

(2) Kabel sudah tersedia dengan modul transmitter.

Modicon Easy M100

Logic Kontroler untuk aplikasi sederhana sampai dengan 40 I/O

Easy M100 Logic Kontroler

Modicon M100 logic Kontroler di rancang sesuai dengan kebutuhan aplikasi sederhana. Tersedia beberapa varian sampai dengan 40 I/O.



Kemudahan yang di tawarkan

- Mudah dalam pemilihan referensi produk.
- Mudah untuk di-mounting dan di-wiring.
- Mudah untuk melakukan konfigurasi dan pemrograman.
- Mudah untuk diuji dan di-debug dengan adanya Standard USB port.
- Mudah untuk diduplikasi dengan adanya Micro SD memory card.

Kehandalan produk

- Input dirancang terlindungi dari overvoltage.
- Modul elektronik dilapisi dengan lapisan khusus untuk melindungi produk dari lingkungan yang buruk.

Pemrograman mesin intuitif dengan software SoMachine Basic EL

- Navigasi sederhana memberikan proses rekayasa yang lebih efisien.
- Semua pemrograman, visualisasi, dan commissioning ditangani dalam satu antar muka yang intuitif.
- Tersedia gratis untuk di-download.
- Tidak ada pelatihan yang dibutuhkan.



SoMachine
Basic EL

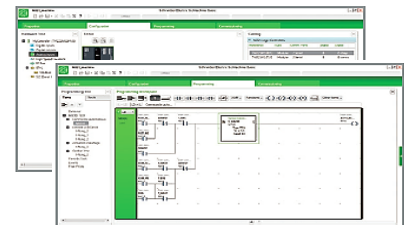

Control Architecture with Modicon Easy M100 Logic Controller

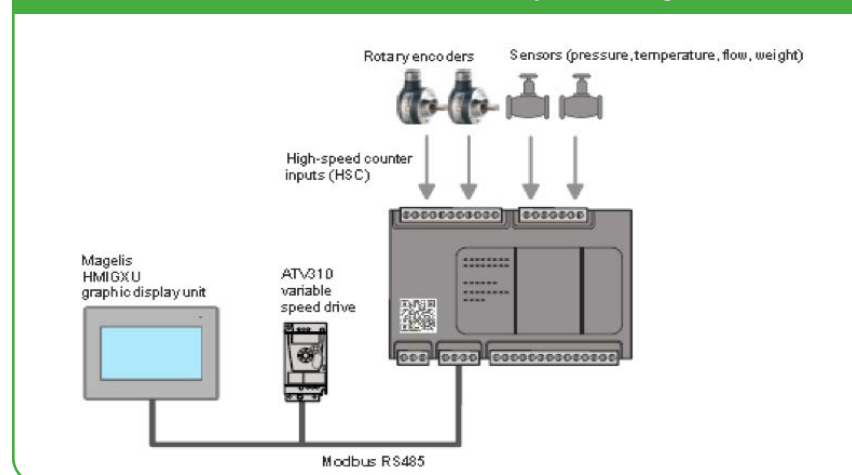



TM100C16RN



TM100C24RN



TM100C40RN



EcoStruxure Machine
Expert Basic EL

Modicon Easy M100

Logik Kontroler untuk aplikasi sederhana sampai dengan 40 I/O

■ Modicon Easy M100 Logic kontroler ⁽¹⁾

Jumlah Logic I/O	Logic Input	Logic Output	Port Komunikasi yang Terintegrasi ⁽²⁾ Serial Link (RJ45)	Berat (kg)	Referensi	Harga (Rp) (Sebelum PPN)	SS
100-240VAC power supply							
16 I/O	9 Sink/Source, 24 VDC Input, 3 regular input, 2 high speed input for HSC, 4 fast input untuk FC	7 Relay Output	1	0.295	TM100C16RN	2.651.100	2
24 I/O	14 Sink/Source, 24 VDC Input, 8 regular input, 2 high speed input for HSC, 4 fast input untuk FC	10 Relay Output	1	0.331	TM100C24RN	3.312.500	2
40 I/O	24 Sink/Source, 24 VDC Input, 14 regular input, 2 high speed input for HSC, dan 4 fast input untuk FC	16 Relay Output	1	0.409	TM100C40RN	4.734.000	2

■ Programming Software

Dekripsi	Untuk digunakan dengan	Referensi
EcoStruxure Machine Expert Basic EL	Modicon Easy M100 Logik Kontroler, PC harus di lengkapi dengan Windows XP SP3 atau Windows 7 atau 8 (32 Bit / 64 Bit)	⁽³⁾

Catatan :

⁽¹⁾ M100 Kontroler disuplai lengkap dengan :

- Terminal blok screw untuk konektor IO
- Terminal blok screw untuk konektor power supply
- Terminal blok screw untuk konektor serial

⁽²⁾ Setiap M100 Logic Kontroler mempunyai Embedded USB Mini-B port untuk programming.

⁽³⁾ Untuk mengunduh software ini silakan kunjungi website kami di www.schneider-electric.com

Modicon Easy M200

Logic Kontroler untuk aplikasi sederhana sampai dengan 188 I/O



Modicon M200 Logic Kontroler

- Dirancang sesuai dengan kebutuhan aplikasi sederhana.
- Dilengkapi dengan opsional Analog dan Digital I/O dan communication cartridges.
- Dilengkapi dengan I/O expansion module Modicon TM3 range.

Control architecture with Modicon Easy M200 logic controller

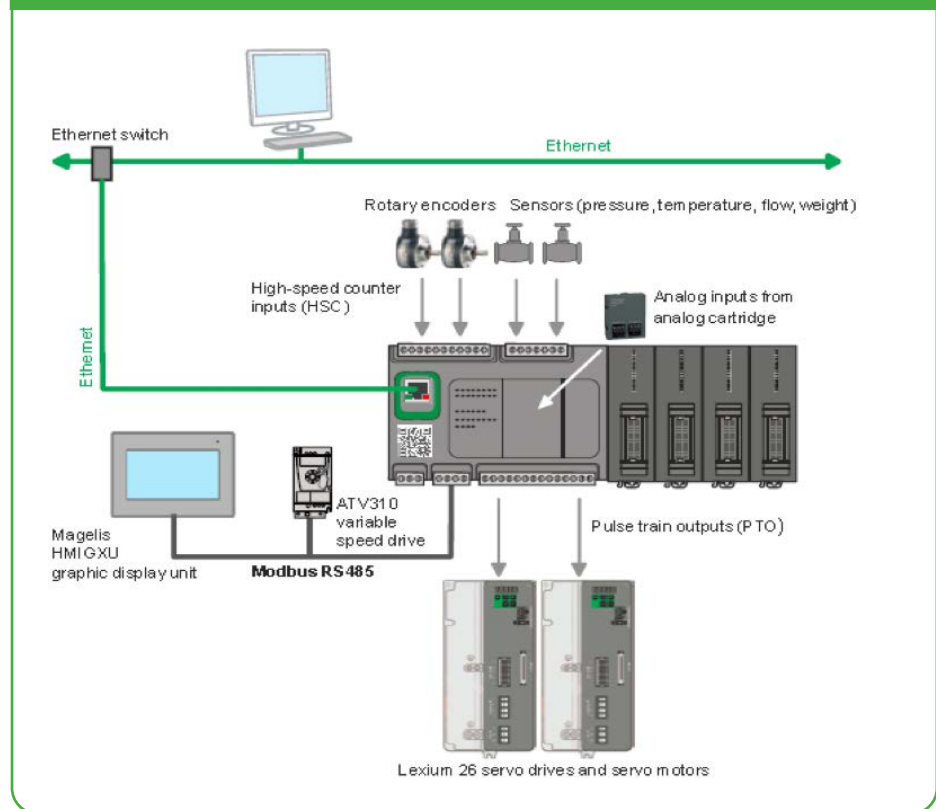

Pemrograman mesin intuitif dengan software SoMachine Basic EL

- Navigasi sederhana memberikan proses rekayasa yang lebih efisien.
- Semua pemrograman, visualisasi, dan commissioning ditangani dalam satu antar muka yang intuitif.
- Tersedia gratis untuk di download.
- Tidak ada pelatihan yang dibutuhkan.



SoMachine
Basic EL

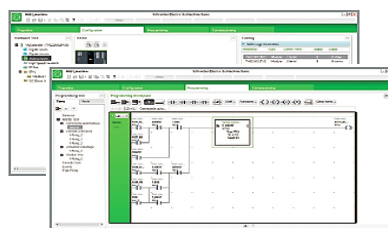



TM200C16R



TM200CE24R



TM200CE40R

Modicon Easy M200

Logic Kontroler untuk aplikasi sederhana sampai dengan 188 I/O

■ Modicon M200 Logic kontroler ⁽¹⁾

Jmlh Logic I/O	Logic Input	Logic Output	Port Komunikasi yang Terintegrasi ⁽²⁾		Referensi	Harga (Rp) (Sebelum PPN)	SS
			Ethernet (RJ45)	Serial Link (RJ45)			
100-240VAC power supply							
16 I/O	9 sink/source, 24 VDC inputs, 1 regular input, 4 high-speed inputs for HSC, and 4 fast inputs for FC	7 Relay Output	-	1	TM200C16R	3.147.200	2
24 I/O	14 sink/source, 24 VDC inputs, 6 regular inputs, 4 high-speed inputs for HSC, and 4 fast inputs for FC	10 Relay Output	1	1	TM200C24R	3.753.500	2
40 I/O	24 sink/source, 24 VDC inputs, 16 regular inputs, 4 high-speed inputs for HSC, and 4 fast inputs for FC	16 Relay Output	-	1	TM200C40R	5.523.700	2
			1	1	TM200CE40R	6.090.800	2
24VDC power supply							
16 I/O	9 sink/source, 24 V c inputs, 1 regular input, 4 high-speed inputs for HSC, and 4 fast inputs for FC	7 source outputs, 5 regular transistor outputs and 2 fast outputs (PWM/PLS/PTO)	-	1	TM200C16T	3.593.400	2
24 I/O	14 sink/source, 24 V c inputs, 6 regular inputs, 4 high-speed inputs for HSC, and 4 fast inputs for FC	10 source outputs, 8 regular transistor outputs and 2 fast outputs (PWM/PLS/PTO)	1	1	TM200C24T	4.354.500	2
40 I/O	24 sink/source, 24 V c inputs, 16 regular inputs, 4 high-speed inputs for HSC, and 4 fast inputs for FC	16 source outputs, 14 regular transistor outputs and 2 fast outputs (PWM/PLS/PTO)	-	1	TM200C40T	6.425.800	2
			1	1	TM200CE40T	7.013.000	2

Catatan :

(1) M200 Kontroler disuplai lengkap dengan :

- Terminal blok screw yang dapat di lepas untuk konektor IO
- Terminal blok screw yang dapat di lepas untuk konektor power supply
- Terminal blok screw yang dapat di lepas untuk konektor serial

(2) Setiap M200 Logic Kontroler mempunyai Embedded USB Mini-B port untuk programming

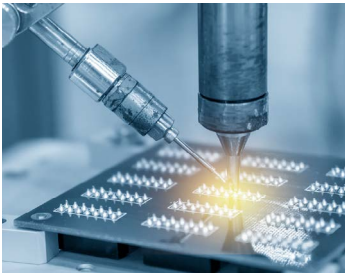

E&E application

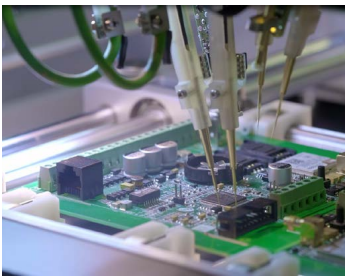

Semicon application



Packaging application



Material Working application

Easy Lexium 18

Easy Lexium 18 servo drives & BCH18 servo motors

Easy Lexium 18 range

Didesain khusus untuk aplikasi otomasi mesin sederhana.



Produk yang mudah digunakan untuk pengguna pemula

Easy Lexium 18 servo drive and BCH18 servo motor adalah kombinasi yang ideal untuk integrasi dan instalasi pada aplikasi mesin otomasi. Produk ini memiliki nilai performa dan harga kompetitif yang sangat tinggi untuk mesin otomasi sederhana.



Tepat guna untuk bermacam aplikasi

- Easy Lexium 18 servo drives memiliki 10 digital inputs (termasuk 2 fast inputs) dan 6 digital outputs.
- Servo drives Lexium 18 dilengkapi braking resistor yang terintegrasi dan sudah menggabungkan fitur auto-tuning dan kontrol posisi.



Pemilihan produk hingga aplikasi yang mudah

- Mudah dipahami dalam memilih spesifikasi produk yang dicari
- Mudah dalam instalasi dan sistem kabel
- Mudah pada proses konfigurasi dengan software SoMove
- Mudah dalam melakukan modifikasi dan perubahan sesuai aplikasi yang dituju
- Mudah dalam koneksi dengan produk PLC Schneider Electric lainnya



Ketahanan produk

- Batang motor memiliki proteksi IP65 sebagai standar
- Motor dapat dioperasikan pada temperatur 0 - 40°C
- Circuit board yang sudah memiliki coating untuk ketahanan di lingkungan yang ekstrim.

■ Easy Lexium 18 Lini Produk

Easy Lexium 18 servo motor dan servo drives memiliki lini produk yang lengkap dan tepat guna untuk berbagai macam aplikasi mesin.

Kelas tenaga dan torsi dapat dipilih secara fleksibel sehingga nilai performa dan harga dapat selalu berada di titik optimum.

■ Aplikasi

Segmen	Industri Elektronika	Semikonduktor	Mesin Packaging	Industri & Manufaktur Bahan
Aplikasi umum	<ul style="list-style-type: none"> ■ Die Cutting ■ Winding ■ Testing ■ Glue Dispenser 	<ul style="list-style-type: none"> ■ Flying Probe Checking ■ Wafer Testing ■ Cristal Growing Furnance 	<ul style="list-style-type: none"> ■ Labeling ■ Folding ■ Sealing ■ Strapping 	<ul style="list-style-type: none"> ■ Laser Cutting ■ Bending ■ Beading ■ Carving

Easy Lexium 18

Easy Lexium 18 servo drives & BCH18 servo motors

Easy Lexium 18 servo drives

■ Easy Lexium 18 servo drive and BCH18 motor combination

Servo drive reference	Harga (Rp) (Sebelum PPN)	Servo motor reference ⁽¹⁾	Harga (Rp) (Sebelum PPN)	Nominal Power		Flange size		Velocity		Current		Torque		Motor Inertia kgcm ²	Moment of inertia	Holding Break
				kW	hp	mm	in	Nominal rpm	Max. rpm	Nominal A	Max. A	Nominal N-m	Peak N-m			
Single-phase supply voltage: 220Vac, 200Vac -15%...240Vac +10%																
LXM18PCU01M2X	Hub Kami	BCH18LBA5332A5C	4.778.000	0.05	0.06	40	1.57	3000	6000	1.1	3.4	0.16	0.48	0.02	Low	No
LXM18PDU01M2X	5.504.000	BCH18LBA5332F5C	6.211.000	0.05	0.06	40	1.57	3000	6000	1.1	3.4	0.16	0.48	0.027	Low	Yes
		BCH18MBA5332A5C	5.010.000	0.05	0.06	40	1.57	3000	6000	1.1	3.9	0.16	0.56	0.04	Middle	No
		BCH18MBA5332F5C	6.442.000	0.05	0.06	40	1.57	3000	6000	1.1	3.9	0.16	0.56	0.046	Middle	Yes
		BCH18LB01332A5C	4.867.000	0.10	0.13	40	1.57	3000	6000	1.1	3.4	0.32	0.96	0.030	Low	No
		BCH18LB01332F5C	6.300.000	0.10	0.13	40	1.57	3000	6000	1.1	3.4	0.32	0.96	0.036	Low	Yes
		BCH18MB01332A5C	5.099.000	0.10	0.13	40	1.57	3000	6000	1.1	3.9	0.32	1.12	0.07	Middle	No
		BCH18MB01332F5C	6.531.000	0.10	0.13	40	1.57	3000	6000	1.1	3.9	0.32	1.12	0.076	Middle	Yes
		BCH18MD01332A5C	4.672.000	0.10	0.13	60	2.36	3000	6000	1.1	3.4	0.32	0.96	0.16	Middle	No
		BCH18MD01332F5C	6.211.000	0.10	0.13	60	2.36	3000	6000	1.1	3.4	0.32	0.96	0.22	Middle	Yes
LXM18PCU02M2X	Hub Kami	BCH18LD02332A5C	4.876.000	0.20	0.27	60	2.36	3000	6000	1.6	5.1	0.64	1.92	0.15	Low	No
LXM18PDU02M2X	5.635.000	BCH18LD02332F5C	6.415.000	0.20	0.27	60	2.36	3000	6000	1.6	5.1	0.64	1.92	0.21	Low	Yes
		BCH18MD02332A5C	4.858.000	0.20	0.27	60	2.36	3000	6000	1.6	5.9	0.64	2.24	0.268	Middle	No
		BCH18MD02332F5C	6.398.000	0.20	0.27	60	2.36	3000	6000	1.6	5.9	0.64	2.24	0.328	Middle	Yes
		BCH18MF02332A5C	5.357.000	0.20	0.27	80	3.15	3000	6000	1.6	5.1	0.64	1.92	0.55	Middle	No
		BCH18MF02332F5C	6.958.000	0.20	0.27	80	3.15	3000	6000	1.6	5.1	0.64	1.92	0.68	Middle	Yes
LXM18PCU04M2X	Hub Kami	BCH18LD04332A5C	5.010.000	0.40	0.54	60	2.36	3000	6000	2.8	8.5	1.27	3.81	0.25	Low	No
LXM18PDU04M2X	5.635.000	BCH18LD04332F5C	6.549.000	0.40	0.54	60	2.36	3000	6000	2.8	8.5	1.27	3.81	0.31	Low	Yes
		BCH18MD04332A5C	5.125.000	0.40	0.54	60	2.36	3000	6000	2.6	9.3	1.27	4.45	0.478	Middle	No
		BCH18MD04332F5C	6.664.000	0.40	0.54	60	2.36	3000	6000	2.6	9.3	1.27	4.45	0.54	Middle	Yes
		BCH18MF04332A5C	5.535.000	0.40	0.54	80	3.15	3000	6000	2.6	9.3	1.27	4.45	1.19	Middle	No
		BCH18MF04332F5C	7.136.000	0.40	0.54	80	3.15	3000	6000	2.6	9.3	1.27	4.45	1.33	Middle	Yes
LXM18PCU07M2X	Hub Kami	BCH18LF07332A5C	5.775.000	0.75	1.01	80	3.15	3000	6000	5.1	15.6	2.39	7.17	0.78	Low	No
LXM18PDU07M2X	6.516.000	BCH18LF07332F5C	7.376.000	0.75	1.01	80	3.15	3000	6000	5.1	15.6	2.39	7.17	0.93	Low	Yes
		BCH18MF07332A5C	6.210.000	0.75	1.02	80	3.15	3000	6000	4.9	17.3	2.39	8.37	1.79	Middle	No
		BCH18MF07332F5C	7.896.000	0.75	1.02	80	3.15	3000	6000	4.9	17.3	2.39	8.37	1.9	Middle	Yes
LXM18PCU10M2X	Hub Kami	BCH18MM08132A6C	9.168.000	0.85	1.15	130	5.12	1500	3000	7.3	22	5.39	16.17	14	Middle	No
LXM18PDU10M2X	7.440.000	BCH18MM08132F6C	11.506.000	0.85	1.15	130	5.12	1500	3000	7.3	22	5.39	16.17	14.7	Middle	Yes
		BCH18LF10332A5C	6.415.000	1.00	1.34	80	3.15	3000	6000	6.8	21.5	3.18	9.54	0.994	Low	No
		BCH18LF10332F5C	8.017.000	1.00	1.34	80	3.15	3000	6000	6.8	21.5	3.18	9.54	1.12	Low	Yes
		BCH18MF10332A5C	6.893.000	1.00	1.34	80	3.15	3000	6000	6.5	22.8	3.18	11.1	2.16	Middle	No
		BCH18MF10332F5C	8.579.000	1.00	1.34	80	3.15	3000	6000	6.5	22.8	3.18	11.1	2.32	Middle	Yes
		BCH18LH10332A6C	7.344.000	1.00	1.34	100	3.94	3000	6000	7.3	22	3.18	9.54	1.43	Low	No
		BCH18LH10332F6C	9.085.000	1.00	1.34	100	3.94	3000	6000	7.3	22	3.18	9.54	1.53	Low	Yes
LXM18PCU15M2X	Hub Kami	BCH18MM13132A6C	10.767.000	1.30	1.76	130	5.12	1500	3000	9.6	29.2	8.34	25	20.88	Middle	No
LXM18PDU15M2X	7.546.000	BCH18MM13132F6C	13.106.000	1.30	1.76	130	5.12	1500	3000	9.6	29.2	8.34	25	21.54	Middle	Yes
		BCH18LH15332A6C	8.592.000	1.50	2.01	100	3.94	3000	6000	9.2	28.8	4.77	14.3	2.09	Low	No
		BCH18LH15332F6C	10.333.000	1.50	2.01	100	3.94	3000	6000	9.2	28.8	4.77	14.3	2.21	Low	Yes
Three-phase supply voltage: 220Vac, 200Vac -15%...240Vac +10%																
LXM18PCU20M3X	Hub Kami	BCH18MM18132A6C	12.601.000	1.80	2.44	130	5.12	1500	3000	14	42	11.5	32.2	27.79	Middle	No
LXM18PDU20M3X	10.721.000	BCH18MM18132F6C	14.939.000	1.80	2.44	130	5.12	1500	3000	14	42	11.5	32.2	28.45	Middle	Yes
		BCH18LH20332A6C	9.408.000	2.00	2.68	100	3.94	3000	6000	13.2	41	6.37	19.1	2.64	Low	No
		BCH18LH20332F6C	11.149.000	2.00	2.68	100	3.94	3000	6000	13.2	41	6.37	19.1	2.74	Low	Yes
LXM18PCU30M3X	Hub Kami	BCH18MR24132A6C	16.724.000	2.40	3.26	180	7.09	1500	3000	18.6	56	15.1	45.1	46.32	Middle	No
LXM18PDU30M3X	11.061.000	BCH18MR24132F6C	23.319.000	2.40	3.26	180	7.09	1500	3000	18.6	56	15.1	45.1	51.1	Middle	Yes
		BCH18LM30332A6C	13.229.000	3.00	4.02	130	5.12	3000	6000	18.6	56	9.8	29.4	7.63	Low	No
		BCH18LM30332F6C	15.396.000	3.00	4.02	130	5.12	3000	6000	18.6	56	9.8	29.4	8.3	Low	Yes

(1) Equipped with 23bit optic incremental encoder



LXM18P●U01M2X
LXM18P●U02M2X
LXM18P●U04M2X



LXM18P●U07M2X
LXM18P●U10M2X



LXM18P●U20M3X
LXM18P●U30M3X

Easy Lexium 18

Easy Lexium 18 servo drives & BCH18 servo motors

Easy Lexium 18 servo drives

■ Panduan Pemilihan

To order a Easy Lexium 18 servo drive, make up the reference as follows

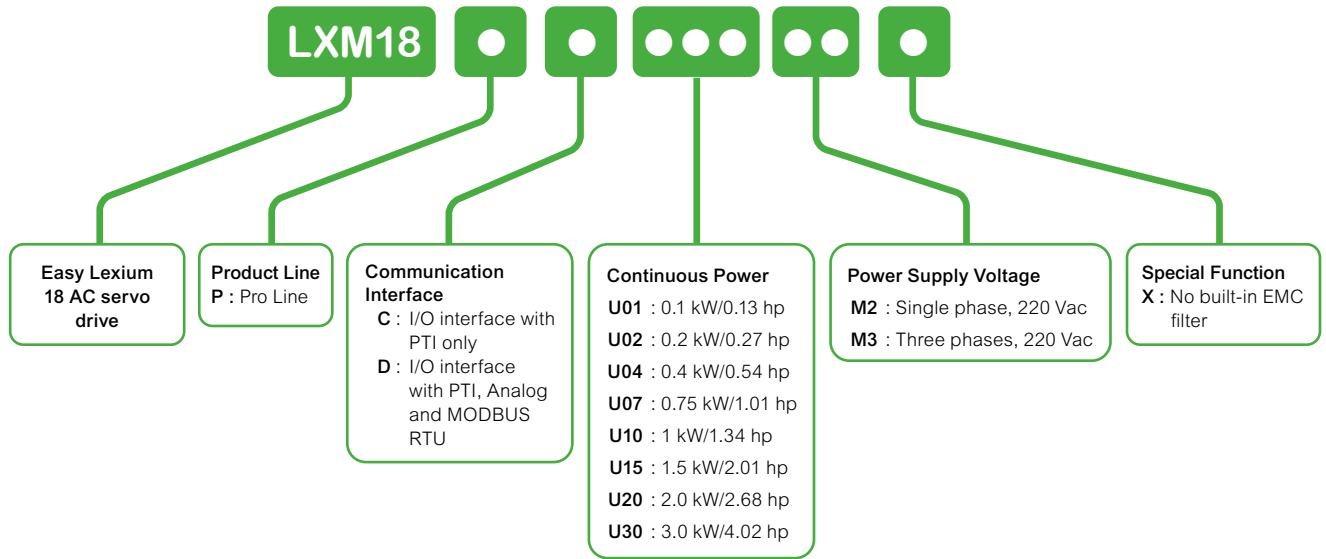

■ Dimensi & berat



Servo drive reference	Harga (Rp) (Sebelum PPN)	Housing	Dimensions						Weight	
			H (height)		W (width)		D (depth)		kg	lb
			mm	in	mm	in	mm	in		
LXM18PCU01M2X	Hub Kami	Size 1	155.5	6.12	48	1.89	166.5	6.55	1.19	2.62
LXM18PDU01M2X	5.504.000									
LXM18PCU02M2X	Hub Kami									
LXM18PDU02M2X	5.635.000									
LXM18PCU04M2X	Hub Kami									
LXM18PDU04M2X	5.635.000									
LXM18PCU07M2X	Hub Kami	Size 2	155.5	6.12	78	3.07	166.5	6.55	1.79	3.95
LXM18PDU07M2X	6.516.000									
LXM18PCU10M2X	Hub Kami									
LXM18PDU10M2X	7.440.000									
LXM18PCU15M2X	Hub Kami									
LXM18PDU15M2X	7.546.000									
LXM18PCU20M3X	Hub Kami	Size 3	208	8.19	93	3.66	191.8	7.55	2.89	6.37
LXM18PDU20M3X	10.721.000									
LXM18PCU30M3X	Hub Kami									
LXM18PDU30M3X	11.061.000									

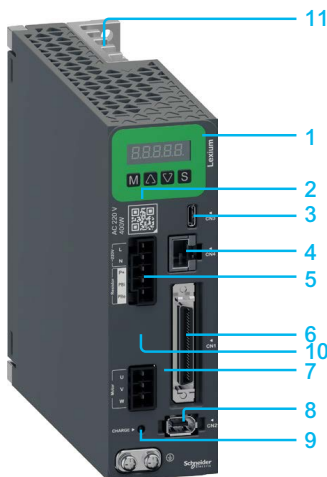

■ Deskripsi

On the drive front:

- 1 HMI interface, 7-segment display, 4 buttons (mode, value up, value down, set)
- 2 QR code: link to SE product maintenance page
- 3 Type-C connector for commissioning the servo drives (marked CN3)
- 4 RJ45 connector for Modbus RS485 (marked CN4)
- 5 Connector for power (marked L,N,P+, PBi, PBe) (1)
- 6 I/O interface (PTI/Analog interface, marked CN1)
- 7 Connector (1) for motor connection (marked U, V, W)
- 8 Connector for motor encoder (marked CN2)
- 9 Charge indicator LED
- 10 Protected earth ground connector (marked)

On the drive top

- 11 Heatsink and fan + fan cover on servo drive size 2 and 3
Heatsink on servo drive size 1

Easy Lexium 18

Easy Lexium 18 servo drives & BCH18 servo motors

Connection accessories for Easy Lexium 18 servo drives

■ Connection accessories for Easy lexium 18 servo drives



VW3M4B01

Penamaan	Deskripsi	Untuk digunakan bersama	Referensi	Harga (Rp) (Sebelum PPN)	SS
Connectors					
Connector set for power & motor	Servo drive power input and output connector kit	LXM18PCU●●●● LXM18PDU●●●●	VW3M4B01	238.000	-
IO connector	SCSI 50-pin IO connector kit	LXM18PCU●●●● LXM18PDU●●●●	VW3M4B11	108.000	-
Connector kit for encoder	Firewire 1394 6-pin encoder connector kit	LXM18PCU●●●● LXM18PDU●●●●	VW3M4B21	57.000	-

■ Modbus TCP network cordsets



490NTW000●●●
490NTC000●●●
490NTW000●●●U

Deskripsi	Tipe port	Panjang		Referensi	Harga (Rp) (Sebelum PPN)	SS
		m	ft ⁽¹⁾			
Straight shielded twisted pair cordsets (conforming to EIA/TIA-568, category 5 and IEC1180/EN50173, class D standards)	2 RJ45 connectors	2	6.56	490NTW00002	780.800	-
		5	16.40	490NTW00005	1.766.500	-
		12	39.37	490NTW00012	3.655.500	-
Crossed shielded twisted pair cordsets	2 RJ45 connectors	5	16.40	490NTC00005	2.543.100	-
		15	49.21	490NTC00015	4.205.500	-
Straight shielded twisted pair cordsets (conforming to UL and CSA 22.1 standards)	2 RJ45 connectors	2	6.56	490NTW00002U	906.400	-
		5	16.40	490NTW00005U	1.695.400	-
		15	49.21	490NTW00012U	3.094.200	-
Crossed shielded twisted pair cordsets	2 RJ45 connectors	5	16.40	490NTC00005U	1.396.700	-

⁽¹⁾ Also available in 40 and 80 m/131 and 262 ft lengths.

Easy Lexium 18

Easy Lexium 18 servo drives & BCH18 servo motors

Braking resistor for Easy Lexium 18 servo drives

■ Braking resistor

Internal braking resistor

The built-in braking resistor absorbs the braking energy. If the DC bus voltage in the servo drive exceeds a specified value, this braking resistor is activated. The restored energy is converted into heat by the braking resistor.

It enables maximum transient braking torque.

External braking resistor

When the servo motor has to be braked frequently, an external braking resistor is required to dissipate the excess braking energy. In this case, the internal braking resistor must be deactivated.

Several external braking resistors can be connected in parallel. The servo drive monitors the power dissipated in the braking resistor.



VW3A760●R●●



VW3A773●



The operating temperature around the unit can be between 0 and + 50°C/+ 32 and + 122 °F.

Power rating range	Ohmic value	Continuous power	Connection	Degree of protection	Referensi	Harga (Rp) (Sebelum PPN)	SS
100 W, 200 W, 400 W	72	400	3 m cable (9.84 ft)	IP65	VW3A7607R30	13.858.000	-
750 W, 1 kW, 1.5 kW	27	400	0.75 m cable (2.46 ft)	IP65	VW3A7603R07	8.431.000	-
2 kW, 3 kW	16	960	M6 terminal	IP20 UL	VW3A7733	4.035.000	-

Catatan: The total continuous power dissipated in the external braking resistor(s) must be less than or equal to the nominal power of the Easy Lexium 18 servo drive.

Easy Lexium 18

Easy Lexium 18 servo drives & BCH18 servo motors

Additional EMC input filters

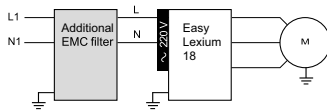

Easy Lexium 18 servo drive with additional EMC filter

■ Additional EMC input filters

Applications

Easy Lexium 18 servo drives require external input filters to comply with the EMC standard for variable speed electrical power drive “products” IEC/EN 61800-3, edition 2, category C3 in environment 2, and to comply with the European directive on EMC (electromagnetic compatibility).

- Additional EMC filters are mounted next to the device. They have tapped holes for mounting in an enclosure.
- The maximum servo motor cable length conforming to IEC/EN 61800-3 category C3 (1) in environment 2 is 25 m/82.02 ft.
- Use according to the type of line supply
- Additional EMC filters can only be used on TN (neutral connection) or TT (neutral to ground) systems.
- Easy Lexium 18 servo drives cannot be used on IT (impedance grounded or isolated neutral) systems. Standard IEC/EN 61800-3, appendix D2.1, states that on IT systems, filters can cause permanent insulation monitors to operate in a random manner.
- If a machine has to be installed on an IT system, an isolation transformer must be inserted in order to recreate a TT system on the secondary side.



VW3A442●

For servo drive (1 x EMC filter and a single Easy Lexium 18 servo drive)	Nominal power	Line current	Referensi	Harga (Rp) (Sebelum PPN)	SS
Single phase 220Vac, 200Vac -15%...240Vac +10%					
LXM18PCU01M2X	0.5 to 0.75 kW (0.13 to 1.01 hp)	9 A	VW3A4420	6.167.000	
LXM18PDU01M2X					
LXM18PCU02M2X					
LXM18PDU02M2X					
LXM18PCU04M2X					
LXM18PDU04M2X					
LXM18PCU07M2X					
LXM18PDU07M2X					
LXM18PCU10M2X	1 and 1.5 kW (1.34 and 2.01 hp)	16 A	VW3A4421	5.631.000	
LXM18PDU10M2X					
LXM18PCU15M2X					
LXM18PDU15M2X					
Three-phase supply voltage: 220Vac, 200Vac -15%...240Vac +10%					
LXM18PCU20M3X	2 and 3 kW (2.68 and 4.02 hp)	25 A	VW3A4423	6.431.000	
LXM18PDU20M3X					
LXM18PCU30M3X					
LXM18PDU30M3X					

Easy Lexium 18

Easy Lexium 18 servo drives & BCH18 servo motors

Motor starters, Protection using class J fuses (UL certification)



GV2P ●●

+



LC1 ●●●●●●

+



LXM18P ●●●●●●●●

Motor starters

Applications

The combinations listed below can be used to create a complete motor starter unit comprising a circuit-breaker, a contactor and a Easy Lexium 18 servo drive.

- The circuit-breaker provides protection against accidental short-circuits, disconnection and, if necessary, isolation.
- The contactor activates and manages any safety functions, as well as isolating the servo motor on stopping.

The servo drive controls the servo motor, provides protection against short-circuits between the servo drive and the servo motor and protects the motor cable against overloads. Overload protection is provided by the servo drive's motor thermal protection.

Kombinasi

Servo drive		Circuit-breaker			Contactor	
Referensi	Nominal power (kW/hp)	Referensi	Rating (A)	Harga (Rp) (Sebelum PPN)	Referensi ⁽²⁾	Komposisi ⁽¹⁾
Circuit-breakers for single drive installation according to IEC 60364-5-52						
Single phase 220Vac, 200Vac -15%...240Vac +10%						
LXM18PCU01M2X	0.1/0.13	GV2P14	10	1.244.000	LC1K0610●●	3 poles + 1 N/O auxiliary contact
LXM18PDU01M2X						
LXM18PCU02M2X	0.2/0.27	GV2P14	10	1.244.000	LC1K0610●●	3 poles + 1 N/O auxiliary contact
LXM18PDU02M2X						
LXM18PCU04M2X	0.4/0.54	GV2P14	10	1.244.000	LC1K09●●	4 poles
LXM18PDU04M2X						
LXM18PCU07M2X	0.75/1.01	GV2P14	10	1.244.000	LC1K09●●	4 poles
LXM18PDU07M2X						
LXM18PCU10M2X	1.0/1.34	GV2P14	10	1.244.000	LC1K09●●	4 poles
LXM18PDU10M2X						
LXM18PCU15M2X	1.5/2.01	GV2P16	14	1.303.000	LC1D18●●	3 poles + 1 N/O auxiliary contact + 1 N/C auxiliary contact
LXM18PDU15M2X						
Three-phase supply voltage: 220Vac, 200Vac -15%...240Vac +10%						
LXM18PCU20M3X	2.0/2.68	GV2P16	14	1.303.000	LC1D18●●	3 poles + 1 N/O auxiliary contact + 1 N/C auxiliary contact
LXM18PDU20M3X						
LXM18PCU30M3X	3.0/4.02	GV2P20	18	1.303.000	LC1D32●●	
LXM18PDU30M3X						

(1) Silakan merujuk ke halaman [CONTACTORS AND PROTECTION RELAYS](#) di situs web kami.

(2) Ganti ●● dengan kode tegangan rangkaian kontrol pada tabel di bawah ini:

	Volts ~	230	240
LC1K	50/60 Hz	P7	U7
	Volts ~	230	230/240
LC1D	50 Hz	P5	U5
	60 Hz		U6
	50/60 Hz	P7	U7

Protection using class J fuses (UL certification)

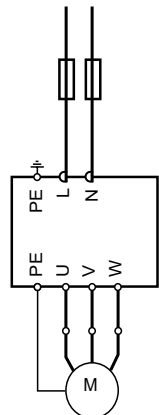

Easy LXM18 servo drive, BCH18 servo motor with fuse protection

Servo drive		Fuse to be placed upstream (A)
Referensi	Nominal power (kW/hp)	
Single phase 220Vac, 200Vac -15%...240Vac +10%		
LXM18PCU01M2X, LXM18PDU01M2X	0.1/0.13	5
LXM18PCU02M2X, LXM18PDU02M2X	0.2/0.27	20
LXM18PCU04M2X, LXM18PDU04M2X	0.4/0.54	20
LXM18PCU07M2X, LXM18PDU07M2X	0.75/1.01	40
LXM18PCU10M2X, LXM18PDU10M2X	1.0/1.34	40
LXM18PCU15M2X, LXM18PDU15M2X	1.5/2.01	40
Three-phase supply voltage: 220Vac, 200Vac -15%...240Vac +10%		
LXM18PCU20M3X, LXM18PDU20M3X	2.0/2.68	80
LXM18PCU30M3X, LXM18PDU30M3X	3.0/4.02	80

Easy Lexium 18

Easy Lexium 18 servo drives & BCH18 servo motors

BCH18 servo motors, Holding brake controller



40 mm/1.58 in

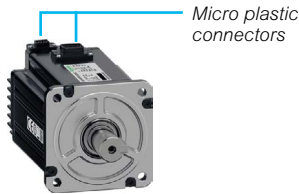

80 mm/3.15 in

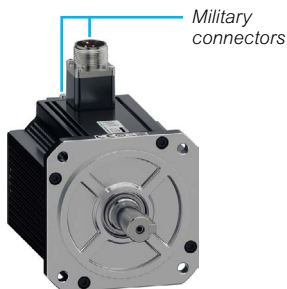

130 mm/5.12 in



VW3M3103

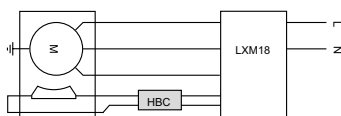

Servo motor with integrated holding brake

BCH18 servo motors

Presentasi

BCH18 motors are synchronous AC servo motors,

- Available in several flange sizes and shaft diameters, some with two shaft diameters:
 - 40 mm (1.58 in) – Shaft diameter 8 mm (0.31 in)
 - 60 mm (2.36 in) – Shaft diameter 8 mm (0.31 in) or 14 mm (0.55 in)
 - 80 mm (3.15 in) – Shaft diameter 14 mm (0.55 in) or 19 mm (0.75 in)
 - 100 mm (3.94 in) – Shaft diameter 22 mm (0.87 in)
 - 130 mm (5.12 in) – Shaft diameter 22 mm (0.87 in), 24 mm (0.94 in) or 28 mm (1.102 in)
 - 180 mm (7.09 in) – Shaft diameter 35 mm (1.38 in)
- available with or without holding brake (depending on model)
- available with low or middle motor inertia

Depending on flange size, the BCH18 motors are supplied:

- with micro plastic connectors
- with military connectors

Deskripsi

BCH18 servo motors, with a 3-phase stator and a rotor with rare earth permanent magnets, consist of:

- 1 Encoder connector (depending on model)
- 2 Power connector (depending on model)
- 3 Casing with RAL 9005 opaque black paint coating
- 4 A keyed shaft end with oil seal
- 5 4-point axial mounting flange
(flange is mechanically compatible with Asian style servo motors)

Cables and connectors to be ordered separately, for connection to Easy Lexium 18 servo drives.

Schneider Electric has taken particular care over the compatibility of BCH18 servo motors and Easy Lexium 18 servo drives. This compatibility is only possible when using cables and connectors sold by Schneider Electric (see pages 62405/13 to 62405/15).

Holding brake controller (HBC)

BCH18 servo motors can be equipped with an electromagnetic holding brake.

Warning: Do not use the holding brake as a dynamic brake for deceleration, as this will quickly damage the brake.

If a servo motor has a holding brake, it is necessary to provide an appropriate control logic, which releases the brake when power is supplied to the servo motor and immobilizes the servo motor shaft when it is stationary.

The holding brake controller amplifies the braking control signal (Digital output) transmitted by the Easy Lexium 18 servo drive, so that the brake is deactivated quickly. It then reduces this control signal so as to decrease the power dissipated by the holding brake.

Penamaan	Deskripsi	Referensi	Harga (Rp) (Sebelum PPN)	SS
Holding brake controller	24 V c power supply Max. power 0.05 kW/0.07 hp IP 20 For mounting on 55 mm/2.17 in 5 rail	VW3M3103	10.352.000	-

Integrated encoder

BCH18 servo motors are equipped with a 23 bit optic incremental encoder which measures the servo motor speed via associated Easy Lexium 18 servo drive. This information is used by the servo drive's position and speed controller.

Easy Lexium 18

Easy Lexium 18 servo drives & BCH18 servo motors

BCH18 servo motors

■ Panduan Pemilihan

Untuk pemesanan BCH18 servo motors, buatlah referensinya sebagai berikut:

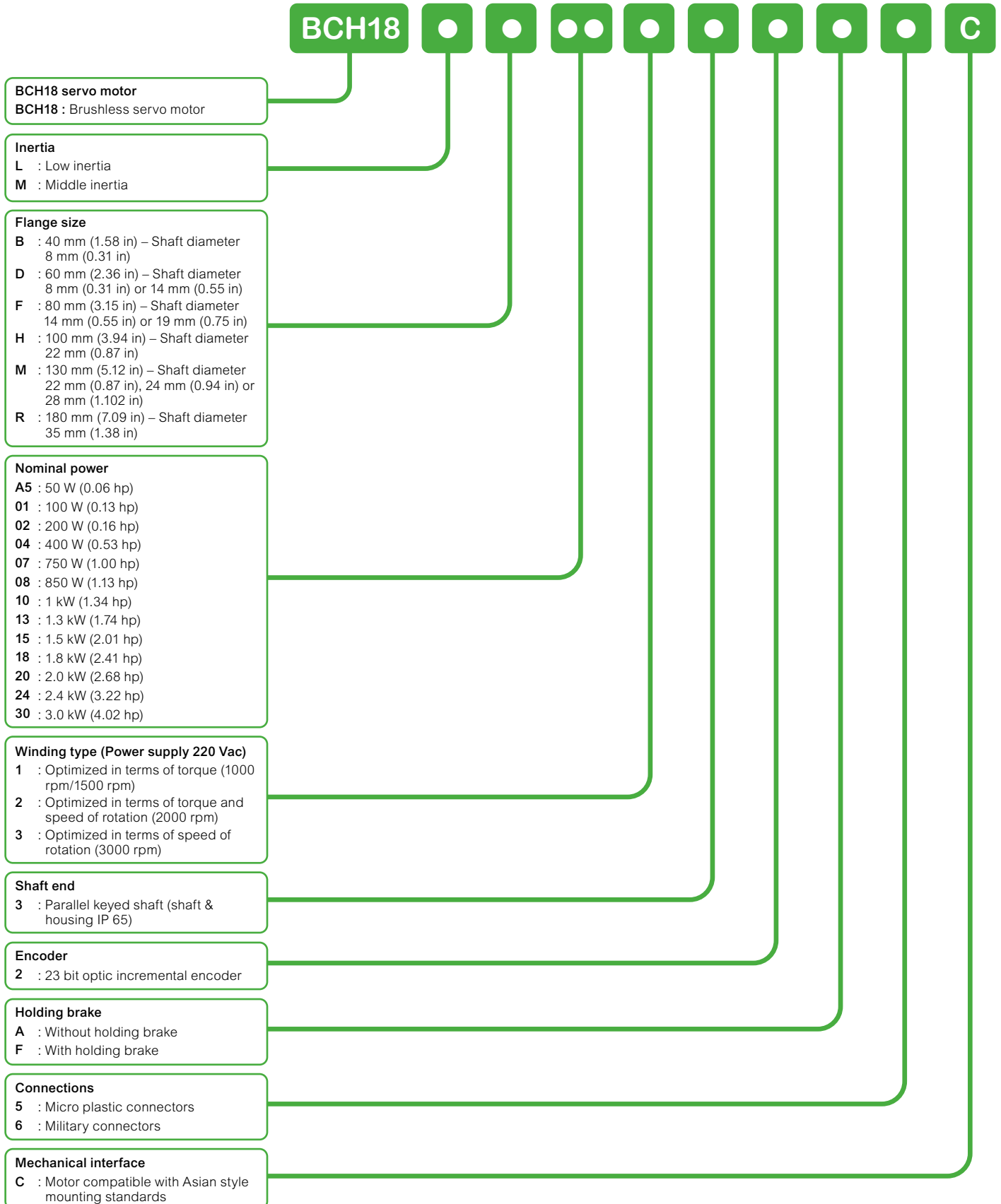

Easy Lexium 18

Easy Lexium 18 servo drives & BCH18 servo motors

BCH18 servo motors

■ Dimensi & Berat

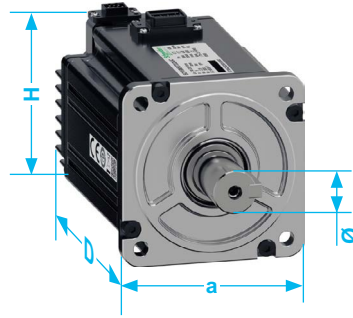

Servo motor	Continuous power		Equipment	Dimensions								Weight	
				Ø (shaft)		a (flange)		H (height)		D (depth)			
				kW	hp	mm	in	mm	in	mm	in	mm	in
BCH18LBA5332A5C	0.05	0.06	Without brake	8	0.31	40	1.57	50.75	2.00	74.90	2.95	0.35	0.77
BCH18LBA5332F5C	0.05	0.06	With brake	8	0.31	40	1.57	50.75	2.00	118.90	4.68	0.60	1.32
BCH18MBA5332A5C	0.05	0.06	Without brake	8	0.31	40	1.57	50.75	2.00	75.20	2.96	0.36	0.79
BCH18MBA5332F5C	0.05	0.06	With brake	8	0.31	40	1.57	50.75	2.00	118.90	4.68	0.61	1.34
BCH18LB01332A5C	0.1	0.13	Without brake	8	0.31	40	1.57	50.75	2.00	83.80	3.30	0.41	0.90
BCH18LB01332F5C	0.1	0.13	With brake	8	0.31	40	1.57	50.75	2.00	127.80	5.03	0.65	1.43
BCH18MB01332A5C	0.1	0.13	Without brake	8	0.31	40	1.57	50.75	2.00	89.10	3.51	0.42	0.93
BCH18MB01332F5C	0.1	0.13	With brake	8	0.31	40	1.57	50.75	2.00	132.80	5.23	0.66	1.46
BCH18MD01332A5C	0.1	0.13	Without brake	8	0.31	60	2.36	68.60	2.70	69.20	2.72	0.65	1.43
BCH18MD01332F5C	0.1	0.13	With brake	8	0.31	60	2.36	68.60	2.70	108.70	4.28	1.05	2.31
BCH18LD02332A5C	0.2	0.16	Without brake	14	0.55	60	2.36	68.60	2.70	76.70	3.02	0.85	1.87
BCH18LD02332F5C	0.2	0.16	With brake	14	0.55	60	2.36	68.60	2.70	116.20	4.57	1.20	2.65
BCH18MD02332A5C	0.2	0.16	Without brake	14	0.55	60	2.36	68.60	2.70	77.90	3.07	0.85	1.87
BCH18MD02332F5C	0.2	0.16	With brake	14	0.55	60	2.36	68.60	2.70	117.40	4.62	1.25	2.76
BCH18MF02332A5C	0.2	0.16	Without brake	14	0.55	80	3.15	88.60	3.49	80.20	3.16	1.35	2.98
BCH18MF02332F5C	0.2	0.16	With brake	14	0.55	80	3.15	88.60	3.49	119.00	4.69	2.10	4.63
BCH18LD04332A5C	0.4	0.53	Without brake	14	0.55	60	2.36	68.60	2.70	92.80	3.65	1.16	2.55
BCH18LD04332F5C	0.4	0.53	With brake	14	0.55	60	2.36	68.60	2.70	132.30	5.21	1.55	3.42
BCH18MD04332A5C	0.4	0.53	Without brake	14	0.55	60	2.36	68.60	2.70	96.10	3.78	1.15	2.54
BCH18MD04332F5C	0.4	0.53	With brake	14	0.55	60	2.36	68.60	2.70	135.60	5.34	1.60	3.53
BCH18MF04332A5C	0.4	0.53	Without brake	14	0.55	80	3.15	88.60	3.49	98.00	3.86	1.95	4.30
BCH18MF04332F5C	0.4	0.53	With brake	14	0.55	80	3.15	88.60	3.49	136.80	5.39	2.70	5.95
BCH18LF07332A5C	0.75	1.00	Without brake	19	0.75	80	3.15	88.60	3.49	105.30	4.15	2.30	5.07
BCH18LF07332F5C	0.75	1.00	With brake	19	0.75	80	3.15	88.60	3.49	144.10	5.67	3.10	6.83
BCH18MF07332A5C	0.75	1.00	Without brake	19	0.75	80	3.15	88.60	3.49	113.70	4.48	2.50	5.51
BCH18MF07332F5C	0.75	1.00	With brake	19	0.75	80	3.15	88.60	3.49	152.50	6.00	3.25	7.17
BCH18MM08132A6C	0.85	1.13	Without brake	22	0.87	130	5.12	182.40	7.18	145.50	5.73	6.85	15.10
BCH18MM08132F6C	0.85	1.13	With brake	22	0.87	130	5.12	182.00	7.17	188.50	7.42	8.35	18.41
BCH18LH10332A6C	1	1.34	Without brake	22	0.87	100	3.94	152.20	5.99	140.00	5.51	3.60	7.94
BCH18LH10332F6C	1	1.34	With brake	22	0.87	100	3.94	152.20	5.99	180.50	7.11	5.60	12.35
BCH18LF10332A5C	1	1.34	Without brake	19	0.75	80	3.15	88.60	3.49	118.50	4.67	2.80	6.17
BCH18LF10332F5C	1	1.34	With brake	19	0.75	80	3.15	88.60	3.49	157.30	6.19	3.55	7.83
BCH18MF10332A5C	1	1.34	Without brake	19	0.75	80	3.15	88.60	3.49	128.70	5.07	3.00	6.61
BCH18MF10332F5C	1	1.34	With brake	19	0.75	80	3.15	88.60	3.49	167.50	6.59	3.75	8.27
BCH18MM13132A6C	1.3	1.74	Without brake	22	0.87	130	5.12	182.40	7.18	170.90	6.73	9.00	19.84
BCH18MM13132F6C	1.3	1.74	With brake	22	0.87	130	5.12	182.00	7.17	213.50	8.41	10.60	23.37
BCH18LH15332A6C	1.5	2.01	Without brake	22	0.87	100	3.94	152.20	5.99	159.00	6.26	4.50	9.92
BCH18LH15332F6C	1.5	2.01	With brake	22	0.87	100	3.94	152.20	5.99	199.50	7.85	5.40	11.90
BCH18MM18132A6C	1.8	2.41	Without brake	24	0.94	130	5.12	182.40	7.18	195.90	7.71	11.20	24.69
BCH18MM18132F6C	1.8	2.41	With brake	24	0.94	130	5.12	182.40	7.18	238.50	9.39	12.70	28.00
BCH18LH20332A6C	2	2.68	Without brake	22	0.87	100	3.94	152.20	5.99	174.00	6.85	5.30	11.68
BCH18LH20332F6C	2	2.68	With brake	22	0.87	100	3.94	152.20	5.99	214.50	8.44	6.20	13.67
BCH18MR24132A6C	2.4	3.22	Without brake	35	1.38	180	7.09	231.20	9.10	193.00	7.60	18.00	39.68
BCH18MR24132F6C	2.4	3.22	With brake	35	1.38	180	7.09	231.20	9.10	245.20	9.65	22.45	49.49
BCH18LM30332A6C	3	4.02	Without brake	28	1.10	130	5.12	182.40	7.18	205.90	8.11	10.30	22.71
BCH18LM30332F6C	3	4.02	With brake	28	1.10	130	5.12	182.40	7.18	248.50	9.78	11.80	26.01

Easy Lexium 18

Easy Lexium 18 servo drives & BCH18 servo motors

Connection components for BCH18 servo motors

■ Unshielded Power cables

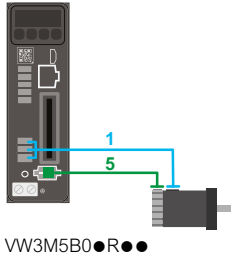

VW3M5B0●R●●

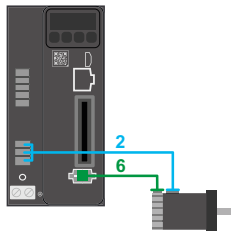

VW3M5B1●R●●

Designation	For use		For cable cross-section	Length		Referensi	Harga (Rp) (Sebelum PPN)	SS
	From servo drive	To servo motor		m	ft			
Toward load, Plastic connector, size 0 - item 1								
Equipped with one plastic connector Size 0 (Motor end)	LXM18P●U01M2X	BCH18LB●●	4G*0.34mm ² (22 AWG)	1.5	4.92	VW3M5B01RA5	166.000	-
		BCH18MB●●		3	9.84	VW3M5B01R03	219.000	-
				5	16.40	VW3M5B01R05	289.000	-
				10	32.81	VW3M5B01R10	465.000	-
				15	49.21	VW3M5B01R15	642.000	-
				20	65.62	VW3M5B01R20	818.000	-
Equipped with one plastic connector size 0, with brake (Motor end)	LXM18P●U01M2X	BCH18LB●●	6G*0.34mm ² (22 AWG)	1.5	4.92	VW3M5B02RA5	184.000	-
		BCH18MB●●		3	9.84	VW3M5B02R03	251.000	-
				5	16.40	VW3M5B02R05	342.000	-
				10	32.81	VW3M5B02R10	571.000	-
				15	49.21	VW3M5B02R15	800.000	-
				20	65.62	VW3M5B02R20	1.029.000	-
Equipped with one plastic connector size 0 (Motor end)	LXM18P●U01M2X	BCH18LB●●	4G*0.34mm ² (22 AWG)	1.5	4.92	VW3M5B03RA5	166.000	-
		BCH18MB●●		3	9.84	VW3M5B03R03	219.000	-
				5	16.40	VW3M5B03R05	289.000	-
				10	32.81	VW3M5B03R10	465.000	-
				15	49.21	VW3M5B03R15	642.000	-
				20	65.62	VW3M5B03R20	818.000	-
Equipped with one plastic connector size 0, with brake (Motor end)	LXM18P●U01M2X	BCH18LB●●	6G*0.34mm ² (22 AWG)	1.5	4.92	VW3M5B04RA5	184.000	-
		BCH18MB●●		3	9.84	VW3M5B04R03	251.000	-
				5	16.40	VW3M5B04R05	342.000	-
				10	32.81	VW3M5B04R10	571.000	-
				15	49.21	VW3M5B04R15	800.000	-
				20	65.62	VW3M5B04R20	1.029.000	-
Equipped with one plastic connector size 1 (Motor end)	LXM18P●U01M2X	BCH18LD●●	4G*0.75mm ² (18 AWG)	1.5	4.92	VW3M5B11RA5	272.000	-
		BCH18LF●●		3	9.84	VW3M5B11R03	347.000	-
		BCH18MD●●		5	16.40	VW3M5B11R05	448.000	-
		BCH18MF●●		10	32.81	VW3M5B11R10	701.000	-
				15	49.21	VW3M5B11R15	953.000	-
				20	65.62	VW3M5B11R20	1.205.000	-
Equipped with one plastic connector size 1, with brake (Motor end)	LXM18P●U01M2X	BCH18LD●●	4G*0.75mm ² (18 AWG)	1.5	4.92	VW3M5B12RA5	290.000	-
		BCH18LF●●		3	9.84	VW3M5B12R03	382.000	-
		BCH18MD●●		5	16.40	VW3M5B12R05	506.000	-
		BCH18MF●●		10	32.81	VW3M5B12R10	815.000	-
				15	49.21	VW3M5B12R15	1.125.000	-
				20	65.62	VW3M5B12R20	1.434.000	-
Equipped with one plastic connector size 1 (Motor end)	LXM18P●U01M2X	BCH18LD●●	4G*0.75mm ² (18 AWG)	1.5	4.92	VW3M5B13RA5	272.000	-
		BCH18LF●●		3	9.84	VW3M5B13R03	347.000	-
		BCH18MD●●		5	16.40	VW3M5B13R05	448.000	-
		BCH18MF●●		10	32.81	VW3M5B13R10	701.000	-
				15	49.21	VW3M5B13R15	953.000	-
				20	65.62	VW3M5B13R20	1.205.000	-
Equipped with one plastic connector size 1, with brake (Motor end)	LXM18P●U01M2X	BCH18LD●●	4G*0.75mm ² (18 AWG)	1.5	4.92	VW3M5B14RA5	290.000	-
		BCH18LF●●		3	9.84	VW3M5B14R03	382.000	-
		BCH18MD●●		5	16.40	VW3M5B14R05	506.000	-
		BCH18MF●●		10	32.81	VW3M5B14R10	815.000	-
				15	49.21	VW3M5B14R15	1.125.000	-
				20	65.62	VW3M5B14R20	1.434.000	-
	25	82.02	VW3M5B14R25	1.743.000	-			

Easy Lexium 18

Easy Lexium 18 servo drives & BCH18 servo motors

Connection components for BCH18 servo motors

■ Unshielded Power cables

Designation	For use		For cable cross-section	Length		Referensi	Harga (Rp) (Sebelum PPN)	SS
	From servo drive	To servo motor		m	ft			
Military connector, Size 1 - item 3								
Equipped with one military connector size 1 (Motor end), and free wires (servo drive side)	LXM18P●U10M2X	BCH18LH103●●	4G*1.5mm ² (16 AWG)	1.5	4.92	VW3M5B21RA5	479.000	-
	LXM18P●U15M2X	BCH18LH153●●		3	9.84	VW3M5B21R03	612.000	-
		BCH18MM081●●		5	16.40	VW3M5B21R05	788.000	-
		BCH18MM131●●		10	32.81	VW3M5B21R10	1.229.000	-
				15	49.21	VW3M5B21R15	1.670.000	-
		20	65.62	VW3M5B21R20	2.112.000	-		
		25	82.02	VW3M5B21R25	2.553.000	-		
Equipped with one military connector size 1, with brake (Motor end) and free wires (servo drive side)	LXM18P●U01M2X	BCH18LH103●●	4G*1.5mm ² (16 AWG)	1.5	4.92	VW3M5B22RA5	569.000	-
	LXM18P●U02M2X	BCH18LH153●●		3	9.84	VW3M5B22R03	728.000	-
	LXM18P●U04M2X	BCH18MM081●●		5	16.40	VW3M5B22R05	939.000	-
	LXM18P●U07M2X	BCH18MM131●●		10	32.81	VW3M5B22R10	1.469.000	-
	LXM18P●U10M2X			15	49.21	VW3M5B22R15	1.998.000	-
		20	65.62	VW3M5B22R20	2.527.000	-		
		25	82.02	VW3M5B22R25	3.057.000	-		
Military connector, Size 2 - item 4								
Equipped with one military connector size 2 (Motor end) and free wires (servo drive side)	LXM18P●U20M2X	BCH18LH203●●	4G*2.5mm ² (14 AWG)	1.5	4.92	VW3M5B31RA5	542.000	-
	LXM18P●U30M2X	BCH18LM303●●		3	9.84	VW3M5B31R03	720.000	-
	LXM18P●U20M3X	BCH18MM181●●		5	16.40	VW3M5B31R05	958.000	-
	LXM18P●U30M3X			10	32.81	VW3M5B31R10	1.552.000	-
				15	49.21	VW3M5B31R15	2.146.000	-
		20	65.62	VW3M5B31R20	2.740.000	-		
		25	82.02	VW3M5B31R25	3.334.000	-		
Equipped with one military connector size 2, with brake (Motor end) and free wires (servo drive side)	LXM18P●U20M2X	BCH18LH203●●	4G*2.5mm ² (14 AWG)	1.5	4.92	VW3M5B32RA5	638.000	-
	LXM18P●U30M2X	BCH18LM303●●		3	9.84	VW3M5B32R03	842.000	-
	LXM18P●U20M3X	BCH18MM181●●		5	16.40	VW3M5B32R05	1.116.000	-
	LXM18P●U30M3X			10	32.81	VW3M5B32R10	1.803.000	-
				15	49.21	VW3M5B32R15	2.489.000	-
		20	65.62	VW3M5B32R20	3.176.000	-		
		25	82.02	VW3M5B32R25	3.862.000	-		
Military connector, Size 3 - item 4								
Equipped with one military connector size 3 (Motor end) and free wires (servo drive side)	LXM18P●U30M2X	BCH18MR241●●	4G*2.5mm ² (14 AWG)	1.5	4.92	VW3M5B41RA5	589.000	-
	LXM18P●U30M3X			3	9.84	VW3M5B41R03	767.000	-
				5	16.40	VW3M5B41R05	1.005.000	-
				10	32.81	VW3M5B41R10	1.599.000	-
				15	49.21	VW3M5B41R15	2.193.000	-
		20	65.62	VW3M5B41R20	2.787.000	-		
		25	82.02	VW3M5B41R25	3.381.000	-		
Equipped with one military connector size 3, with brake (Motor end) and free wires (servo drive side)	LXM18P●U30M2X	BCH18MR241●●	4G*2.5mm ² (14 AWG) + 2*0.5mm ² (20 AWG)	1.5	4.92	VW3M5B42RA5	731.000	-
	LXM18P●U30M3X			3	9.84	VW3M5B42R03	935.000	-
				5	16.40	VW3M5B42R05	1.210.000	-
				10	32.81	VW3M5B42R10	1.896.000	-
				15	49.21	VW3M5B42R15	2.583.000	-
		20	65.62	VW3M5B42R20	3.270.000	-		
		25	82.02	VW3M5B42R25	3.956.000	-		

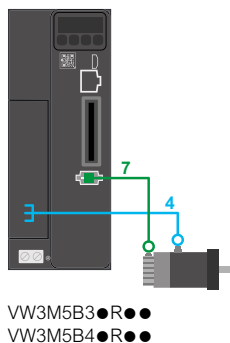
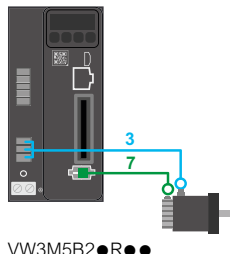

■ Motor power connector kits

Penamaan	Deskripsi	Referensi	Harga (Rp) (Sebelum PPN)	SS
	Motor power connector kit, plastic size 0	VW3M5B10	99.000	-
	Motor power connector kit, toward load, plastic size 1	VW3M5B11	134.000	-
Motor power connector kits	Motor power connector kit, toward back, plastic size 1	VW3M5B12	134.000	-
	Motor power connector kit, military size 1	VW3M5B21	300.000	-
	Motor power connector kit, military size 2	VW3M5B22	358.000	-



VW3M5B10



VW3M5B11



VW3M5B12



VW3M5B21



VW3M5B22

Easy Lexium 18

Easy Lexium 18 servo drives & BCH18 servo motors

Connection components for BCH18 servo motors

Shielded Encoder cables

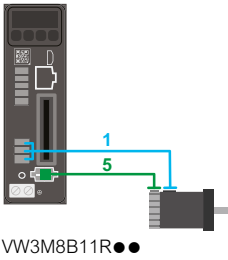

VW3M8B11R ●●

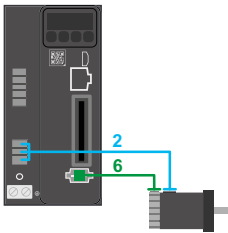

VW3M8B13R ●●

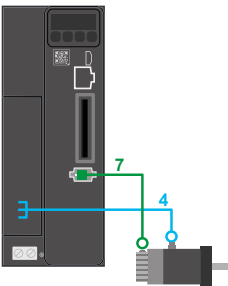

VW3M8B21R ●●



VW3M8B11



VW3M8B21

Designation	For use		For cable cross-section	Length		Referensi	Harga (Rp) (Sebelum PPN)	SS
	From servo drive	To servo motor		m	ft			
Toward load, Plastic connector - item 5								
Equipped with one plastic connector (Motor end) and Sunchu 6-pin connector (servo drive side)	LXM18P●U01M2X	40/60/80 mm flange	2*0.5mm ² (20 AWG) +	1.5	4.92	VW3M8B11RA5	330.000	-
	LXM18P●U02M2X	flange	(20 AWG) +	3	9.84	VW3M8B11R03	408.000	-
	LXM18P●U04M2X	(1.58/ 2.36/	2*0.25 mm ²	5	16.40	VW3M8B11R05	512.000	-
	LXM18P●U07M2X	3.15 in flange)	(24 AWG)	10	32.81	VW3M8B11R10	770.000	-
	LXM18P●U10M2X			15	49.21	VW3M8B11R15	1.029.000	-
				20	65.62	VW3M8B11R20	1.288.000	-
				25	82.02	VW3M8B11R25	1.546.000	-
Toward back, Plastic connector - item 6								
Equipped with one plastic connector (Motor end) and Sunchu 6-pin connector (servo drive side)	LXM18P●U01M2X	40/60/80 mm flange	2*0.5mm ² (20 AWG)	1.5	4.92	VW3M8B13RA5	330.000	-
	LXM18P●U02M2X	flange	(20 AWG)	3	9.84	VW3M8B13R03	408.000	-
	LXM18P●U04M2X	(1.58/ 2.36/	+ 2*0.25 mm ²	5	16.40	VW3M8B13R05	512.000	-
	LXM18P●U07M2X	3.15 in flange)	(24 AWG)	10	32.81	VW3M8B13R10	770.000	-
	LXM18P●U10M2X			15	49.21	VW3M8B13R15	1.029.000	-
				20	65.62	VW3M8B13R20	1.288.000	-
				25	82.02	VW3M8B13R25	1.546.000	-
Military connector - item 7								
Equipped with one military connector (Motor end) and Sunchu 6-pin connector (servo drive side)	LXM18P●U10M2X	100/130/180 mm flange	2*0.5mm ² (20 AWG)	1.5	4.92	VW3M8B21RA5	457.000	-
	LXM18P●U15M2X	flange	(20 AWG)	3	9.84	VW3M8B21R03	534.000	-
	LXM18P●U20M2X	(3.94/ 5.12/	+ 2*0.25 mm ²	5	16.40	VW3M8B21R05	638.000	-
	LXM18P●U30M2X	7.09 in flange)	(24 AWG)	10	32.81	VW3M8B21R10	896.000	-
	LXM18P●U20M3X			15	49.21	VW3M8B21R15	1.155.000	-
	LXM18P●U30M3X			20	65.62	VW3M8B21R20	1.414.000	-
				25	82.02	VW3M8B21R25	1.672.000	-

Motor encoder connector kits

Penamaan	Deskripsi	Referensi	Harga (Rp) (Sebelum PPN)	SS
Motor encoder connector kits	Plastic	VW3M8B11	140.000	-
	Military	VW3M8B21	272.000	-



Life Is On

Schneider
Electric

Soft Starter & Variable Speed Drive

Panorama Produk Altivar	16-3
Soft Starter & Variable Speed Drive	16-3
Altivar Soft Starter ATS01	16-4
Soft Start/ Soft Stop untuk Motor 0.37 - 11 kW	16-4
Soft Start/ Soft Stop untuk Motor 0.75 - 15 kW	16-4
Altivar Soft Starter ATS22	16-5
Tegangan Tiga Phasa 230-440 VAC Koneksi ke Line Motor	16-5
Tegangan Tiga Phasa 230-440 VAC Koneksi ke Line Delta	16-5
Altivar Soft Starter ATS480	16-6
Memperkenalkan Generasi Terbaru Altivar Soft Starter ATS480	16-6
Tegangan tiga phasa 208-690 VAC Koneksi ke Line Motor	16-7
Tegangan tiga phasa 208-690 VAC Koneksi ke Terminal Delta	16-7
Altivar Machine ATV12	16-8
Altivar 12 untuk Motor Induksi 0.18 - 2.2 kW	16-8
Altivar Machine ATV320	16-9
Altivar 320 untuk Motor Induksi 0.37 - 15 kW	16-9
Pilihan dan Aksesori	16-10
Altivar Machine ATV340	16-11
Altivar 340 untuk Motor Induksi 0.37 - 15 kW	16-11
Pilihan dan Aksesori	16-11
Altivar Building ATV212	16-12
Altivar 212 untuk Motor Induksi 0.75 - 75 kW	16-12
Altivar Process ATV630	16-13
Altivar 630 untuk Motor Induksi 0.75 - 160 kW	16-13
Pilihan dan Aksesori	16-14
Altivar Process 930	16-15
Altivar 930 untuk Motor Induksi 0.75 - 315 kW	16-15
Pilihan dan Aksesori	16-16
Easy Altivar ATV310	16-17
Altivar 310 untuk Motor Induksi 0.37 - 22 kW	16-17
Easy Altivar ATV610	16-18
Altivar 610 untuk Motor Induksi 0.75 - 160 kW	16-18

Variable Speed Drive

Machine

Basic Applications

Altivar 12
0.18...4 kW
100...240 V

Plug & Play



Simple Applications

Altivar 320.B
Book Format
0.18...15 kW
200...600 V



Altivar 320.C
Compact Format
0.18...15 kW
200...600 V



Advanced Applications

Altivar 340
0.18...75 kW
200...480 V



Process

Fluid & Gas Handling

Altivar 600
0.75...1800 kW
200...690 V

Fluid & Gas handling



Solid & Mechanics movement

Altivar 900
0.75...1800 kW
200...690 V

Solid & mechanics movement



Building

HVAC

Altivar 212
0...7 kW
100...240 V

Less pollution & more energy efficiency



Easy Series

Small Machine

Altivar 310
0.18...22 kW
380...400 V



Fluid & Gas Handling

Altivar 610
0.75...160 kW
380...415 V



HVAC

Altivar 610
0.75...160 kW
380...415 V



Soft Starter

Machine

Altivar Soft Starter 01
3...32 A
0.37...15 kW
110...480 V

Compact Easy Integration



Altivar Soft Starter 22
17...590 A
7.5...315 kW
110...480 V

Integrated bypass



Process

Altivar Soft Starter 480
17...1200 A
4...900 kW
200...600 V

Replacement of ATS48





Scan QR untuk Data Teknis



ATS01N103FT



ATS01N212QN

Soft Starter

Altivar Soft Starter ATS01

Altivar Soft Starter ATS01

■ Soft Starter untuk motor 0.37 - 11 kW

Daya Motor (kW)			Arus Nominal (A)	Referensi	Harga (Rp) (Sebelum PPN)	SS
Satu Fasa	Tiga Fasa					
230 V	230 V	400 V				
Satu Fasa phase 110...230 V atau 3 fasa 110...480 V 50/60 Hz						
0.37	0.37/0.55	1.1	3	ATS01N103FT	3.005.000	2
0.75	0.75/1.1	2.2	6	ATS01N106FT	3.193.000	2
1.1	1.5	4	9	ATS01N109FT	4.110.000	2
1.5	2.2	5.5	12	ATS01N112FT	4.404.000	2
2.2	2.2/3/4/5.5	7.5/10/11	25	ATS01N125FT	8.652.000	2

■ Soft Start/Soft Stop untuk motor 0.75 - 15 kW

Daya Motor (kW)		Arus Nominal (A)	Referensi	Harga (Rp) (Sebelum PPN)	SS
Tiga Fasa 200-240 VAC 50/60 Hz					
0.75/1.1		6	ATS01N206LU	4.902.000	2
1.5		9	ATS01N209LU	5.303.000	2
2.2/3		12	ATS01N212LU	5.506.000	2
4/5.5		22	ATS01N222LU	7.606.000	2
7.5		32	ATS01N232LU	9.985.000	2
Tiga Fasa 380-415 VAC 50/60 Hz					
1.5/2.2		6	ATS01N206QN	4.742.000	2
3/4		9	ATS01N209QN	5.427.000	2
5.5		12	ATS01N212QN	5.772.000	2
7.5/11		22	ATS01N222QN	7.449.000	2
15		32	ATS01N232QN	9.660.000	2

Download full katalog [Altivar Sofstarter](#)





Scan QR untuk Data Teknis



ATS22D17Q



ATS22C11Q



Scan QR untuk Ecostruxure Motor Control Configurator



VW3G22101

Soft Starter Altivar Soft Starter ATS22

Altivar Soft Starter ATS22

Tegangan tiga fasa 230-440 VAC
Untuk Aplikasi Standar

Daya Motor (kW)		Arus Nominal (IcL) A	Factory Setting A	Display Daya Beban Nominal W	Referensi	Harga (Rp) (Sebelum PPN)	SS
230 V	400 V						
Koneksi ke Line Motor							
4	7.5	14.8	17	39	ATS22D17Q	15.270.000	2
7.5	15	28.5	32	44	ATS22D32Q	17.818.000	2
11	22	42	47	48	ATS22D47Q	22.132.000	2
15	30	57	62	59	ATS22D62Q	25.641.000	2
18.5	37	69	75	63	ATS22D75Q	26.990.000	2
22	45	81	88	66	ATS22D88Q	29.748.000	2
30	55	100	110	73	ATS22C11Q	34.108.000	2
37	75	131	140	82	ATS22C14Q	39.404.000	2
45	90	162	170	91	ATS22C17Q	49.119.000	2
55	110	195	210	117	ATS22C21Q	52.992.000	2
75	132	233	250	129	ATS22C25Q	60.065.000	2
90	160	285	320	150	ATS22C32Q	73.405.000	2
110	220	388	410	177	ATS22C41Q	94.453.000	2
132	250	437	480	218	ATS22C48Q	102.548.000	2
160	315	560	590	251	ATS22C59Q	118.789.000	2
Koneksi ke Line Delta							
5.5	11	25	17	39	ATS22D17Q	15.270.000	2
11	22	48	32	44	ATS22D32Q	17.818.000	2
18.5	45	70	47	48	ATS22D47Q	22.132.000	2
22	55	93	62	59	ATS22D62Q	25.641.000	2
30	55	112	75	63	ATS22D75Q	26.990.000	2
37	75	132	88	66	ATS22D88Q	29.748.000	2
45	90	165	110	73	ATS22C11Q	34.108.000	2
55	110	210	140	82	ATS22C14Q	39.404.000	2
75	132	255	170	91	ATS22C17Q	49.119.000	2
90	160	315	210	117	ATS22C21Q	52.992.000	2
110	220	375	250	129	ATS22C25Q	60.065.000	2
132	250	480	320	150	ATS22C32Q	73.405.000	2
160	315	615	410	177	ATS22C41Q	94.453.000	2
220	355	720	480	218	ATS22C48Q	102.548.000	2
250	400	885	590	251	ATS22C59Q	118.789.000	2

Catatan : Untuk ATS22 tiga fasa 208-600 VAC silakan menghubungi PT. Schneider Indonesia

■ Keypad untuk setting secara remote

(contoh: dipasang di mimik panel)

Deskripsi	Indeks Proteksi	Referensi	Harga (Rp) (Sebelum PPN)	SS
Remote Terminal	IP 54 / NEMA 12	VW3G22101	3.481.000	2
	IP 65	VW3G22102	4.059.000	2

Soft Starter Altivar Soft Starter ATS480

Memperkenalkan generasi terbaru Altivar Soft Starter ATS480

Menggantikan ATS48, Altivar Softstarter ATS480 menawarkan sejumlah pembaruan dan fitur tambahan yang mendukung digitalisasi.



■ Berikut adalah karakteristik dari Altivar Soft Starter ATS480

Us rated operational voltage	208 to 690V
Ie rated operational current	17 to 1200A
Power range	4 to 900kW
Uc Control supply voltage	110 to 230Vac
Connectivity	Modbus, Modbus TCP, EtherNet/IP, PROFINET, PROFIBUS DP, CANopen
Type of control	Torque Control, voltage control
Current limitation	500% Ie (up to 700% rated motor current)
Stop mode	Torque ramp, voltage ramp, dynamic braking, DC injection
Thermal protections	Electronic, PTC, PT100 2 or 3 wires
Other protections	Underload, overload, motor phase loss, line phase inversion excessive acceleration time, current overload, ground leakage

Migrasi dari ATS48 ke Altivar Soft Starter ATS480 sangatlah mudah, dengan panduan sebagai berikut:

- 1 Gantikan notasi **ATS48** dengan **ATS480**
- 2 Gunakan rating yang sama
- 3 Selalu gunakan huruf akhir "Y" sebagai simbol tegangan

Contoh:
ATS48M12Q menjadi ATS480M12Y
ATS48D62Y menjadi ATS480D62Y

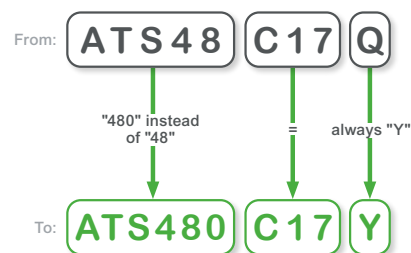

Catatan:

ATS48 dan ATS480 tegangan suplai kontrol bisa saja diperiksa ulang data pada installation guide sebelum menyalakan sistem.



Scan QR untuk
Data Teknis



ATS480D88Y



ATS480C59Y



Ecostruxure Motor
Control Configurator

Soft Starter Altivar Soft Starter ATS480

Altivar Soft Starter ATS480

Tegangan tiga fasa 208-690 VAC

Untuk aplikasi normal atau heavy duty

Daya Motor (kW)		Arus Nominal (IcL) A	Display Daya Beban Nominal W	Referensi	Harga (Rp) (Sebelum PPN)	SS
230 V	400 V					
Koneksi ke Line Motor						
4	7.5	17	38	ATS480D17Y	18.398.000	2
5.5	11	22	54	ATS480D22Y	19.624.000	2
7.5	15	32	84	ATS480D32Y	22.894.000	2
9	18.5	38	96	ATS480D38Y	24.730.000	2
11	22	47	122	ATS480D47Y	26.214.000	2
15	30	62	181	ATS480D62Y	29.677.000	2
18.5	37	75	225	ATS480D75Y	32.149.000	2
22	45	88	270	ATS480D88Y	37.332.000	2
30	55	110	302	ATS480C11Y	40.643.000	2
37	75	140	366	ATS480C14Y	49.453.000	1
45	90	170	459	ATS480C17Y	57.137.000	2
55	110	210	560	ATS480C21Y	61.105.000	2
75	132	250	675	ATS480C25Y	74.702.000	1
90	160	320	882	ATS480C32Y	89.910.000	2
110	220	410	1319	ATS480C41Y	109.861.000	2
132	250	480	1366	ATS480C48Y	133.998.000	2
160	315	590	1711	ATS480C59Y	140.940.000	2
-	355	660	1938	ATS480C66Y	178.518.000	2
220	400	790	2517	ATS480C79Y	229.935.000	2
250	500	1000	2845	ATS480M10Y	261.539.000	2
355	630	1200	3472	ATS480M12Y	298.317.000	2
Koneksi ke Terminal Delta						
7.5	15	29	38	ATS480D17Y	18.398.000	2
9	18.5	38	54	ATS480D22Y	19.624.000	2
15	22	55	84	ATS480D32Y	22.894.000	2
18.5	30	66	96	ATS480D38Y	24.730.000	2
22	45	81	122	ATS480D47Y	26.214.000	2
30	55	107	181	ATS480D62Y	29.677.000	2
37	55	130	225	ATS480D75Y	32.149.000	2
45	75	152	270	ATS480D88Y	37.332.000	2
55	90	191	302	ATS480C11Y	40.643.000	2
75	110	242	366	ATS480C14Y	49.453.000	1
90	132	294	459	ATS480C17Y	57.137.000	2
110	160	364	560	ATS480C21Y	61.105.000	2
132	220	433	675	ATS480C25Y	74.702.000	1
160	250	554	882	ATS480C32Y	89.910.000	2
220	315	710	1319	ATS480C41Y	109.861.000	2
250	355	831	1366	ATS480C48Y	133.998.000	2
-	400	1022	1711	ATS480C59Y	140.940.000	2
315	500	1143	1938	ATS480C66Y	178.518.000	2
355	630	1368	2517	ATS480C79Y	229.935.000	2
-	710	1732	2845	ATS480M10Y	261.539.000	2
500	-	2078	3472	ATS480M12Y	298.317.000	2



Scan QR untuk Data Teknis



ATV12H018M2



ATV12H075M2



ATV12HU40M3



VW3A1006

Variable Speed Drive Altivar Machine ATV12

Altivar Machine ATV12

Untuk Motor Induksi 0.18 - 2.2 kW

Motor Power kW ⁽¹⁾	Arus Input Pada 240 VAC (A)	Arus Nominal Pada 240 VAC (A)	Arus Transien Maksimum ⁽²⁾	Referensi	Harga (Rp) (Sebelum PPN)	SS
Inverter dengan Heatsink, Tegangan Suplai 1 Fasa 200 - 240 VAC 50/60 Hz						
0.18	2.8	1.4	2.1	ATV12H018M2	3.326.000	1
0.37	4.9	2.4	3.6	ATV12H037M2	3.403.000	1
0.55	6.7	3.5	5.3	ATV12H055M2	3.588.000	2
0.75	8.5	4.2	6.3	ATV12H075M2	3.778.000	1
1.5	14.9	7.5	11.2	ATV12HU15M2	5.064.000	2
2.2	20.2	10	15.0	ATV12HU22M2	6.087.000	2

Catatan :

(1) Rating pada nameplate motor, untuk frekuensi switching maksimum 4kHz

(2) Untuk transien selama 60 detik

Untuk tegangan suplai 1 fasa 110VAC dan 3 fasa 220 VAC silakan menghubungi PT. Schneider Indonesia

(3) Untuk dipasang langsung pada panel

Untuk daya 3 kW dan 4 kW dengan tegangan suplai 3 fasa 220 VAC silakan menghubungi PT. Schneider Indonesia

Remote Display Terminal

Deskripsi	Referensi	Harga (Rp) (Sebelum PPN)	SS
Remote Display Terminal	IP 54	VW3A1006	1.310.000 2
	IP 65	VW3A1007	2.785.000 2
Remote - Mounting Cordset	Panjang : 1 m	VW3A1104R10	372.000 2
	Panjang : 3 m	VW3A1104R30	535.000 1

Untuk pemilihan produk **Variable Speed Drive** secara mudah dan tepat berdasarkan aplikasi, gunakan **Ecostruxure Motor Control Configurator** dengan men-scan QR code di bawah ini:





Scan QR untuk
Data Teknis



ATV320U04M2C



ATV320U22N4C



ATV320U07N4B



ATV320U75N4B



Scan QR untuk
Ecostruxure Motor
Control Configurator

Variable Speed Drive Altivar Machine ATV320

Altivar Machine ATV320

Untuk Motor Induksi 0.37 - 15 kW

Drives dengan tipe kontrol COMPACT

Motor Power ⁽¹⁾ (kW)	Arus Input pada Teg. Maksimum (A)	Arus Kontinue Maksimum (A)	Arus Transient Maksimum ⁽²⁾ (A)	Referensi	Harga (Rp) (Sebelum PPN)	SS
Tegangan Suplai 1 fase: 200...240 V 50/60 Hz, EMC filter terintegrasi						
0.18	2.8	1.5	2.3	ATV320U02M2C	4.446.000	2
0.37	4.9	3.3	5	ATV320U04M2C	4.634.000	1
0.55	6.6	3.7	5.6	ATV320U06M2C	4.790.000	2
0.75	8.4	4.8	7.2	ATV320U07M2C	5.048.000	1
1.1	11.6	6.9	10.4	ATV320U11M2C	5.753.000	2
1.5	14.9	8	12	ATV320U15M2C	5.964.000	1
2.2	20.2	11	16.5	ATV320U22M2C	7.559.000	2
Tegangan Suplai 3 fase: 380...500 V 50/60 Hz, EMC filter terintegrasi						
0.37	1.6	1.5	2.3	ATV320U04N4C	5.346.000	1
0.55	2.2	1.9	2.9	ATV320U06N4C	5.774.000	2
0.75	2.8	2.3	3.5	ATV320U07N4C	5.964.000	1
1.1	3.8	3	4.5	ATV320U11N4C	6.600.000	1
1.5	4.9	4.1	6.2	ATV320U15N4C	6.875.000	1
2.2	6.6	5.5	8.3	ATV320U22N4C	8.112.000	1
3	8.4	7.1	10.7	ATV320U30N4C	9.087.000	1
4	10.6	9.5	14.3	ATV320U40N4C	10.552.000	1
5.5	14.5	14.3	21.5	ATV320U55N4C	13.617.000	2
7.5	18.7	17	25.5	ATV320U75N4C	15.502.000	2
11	25.6	27.7	41.6	ATV320D11N4C	20.041.000	2
15	33.3	33	49.5	ATV320D15N4C	25.816.000	2

Drives dengan tipe kontrol BOOK

Motor Power ⁽¹⁾ (kW)	Arus Input pada Teg. Maksimum (A)	Arus Kontinue Maksimum (A)	Arus Transient Maksimum ⁽²⁾ (A)	Referensi	Harga (Rp) (Sebelum PPN)	SS
Tegangan Suplai 3 fase: 380...500 V 50/60 Hz, EMC filter terintegrasi						
0,37	1,6	1,5	2,3	ATV320U04N4B	5.346.000	2
0,55	2,2	1,9	2,9	ATV320U06N4B	5.774.000	2
0,75	2,7	2,3	3,5	ATV320U07N4B	5.964.000	2
1,1	3,8	3	4,5	ATV320U11N4B	6.600.000	2
1,5	4,9	4,1	6,2	ATV320U15N4B	6.875.000	2
2,2	6,6	5,5	8,3	ATV320U22N4B	8.112.000	2
3	8,4	7,1	10,7	ATV320U30N4B	9.087.000	2
4	10,5	9,5	14,3	ATV320U40N4B	10.552.000	2
5,5	14,5	14,3	21,5	ATV320U55N4B	13.617.000	1
7,5	18,7	17	25,5	ATV320U75N4B	15.502.000	1
11	25,6	27,7	41,6	ATV320D11N4B	20.041.000	1
15	33,3	33	49,5	ATV320D15N4B	25.816.000	1

Catatan :

- (1) Rating pada nameplate motor
- (2) Untuk transient selama 60 detik
- (3) Telah dilengkapi kemampuan komunikasi Modbus, CANopen

Soft Starter & Variable Speed Drive

IDVSD



VW3A3607



VW3A8306R30



VW3CANTAP2



VW3A8121



VW3A1006

Variable Speed Drive Aksesori - Altivar Machine ATV320

Modul Komunikasi

Deskripsi	Referensi	Harga (Rp) (Sebelum PPN)	SS
PROFIBUS DP	VW3A3607	11.238.000	2

Modbus serial link

Deskripsi	Length (m)	Referensi	Harga (Rp) (Sebelum PPN)	SS
Aksesori untuk koneksi menggunakan Splitter boxes dan konektor RJ45				
Kabel untuk Modbus Serial link	0.3	VW3A8306R03	214.000	2
	1	VW3A8306R10	235.000	2
	3	VW3A8306R30	323.000	2
Konektor T Modbus	0.3	VW3A8306TF03	714.000	2
	1	VW3A8306TF10	371.000	2
Modbus Line Terminator R = 120 Ohm C = 1 nf		VW3A8306RC	145.000	2
Aksesori lainnya				
CANopen Cable	0.3	VW3CANCARR03	202.000	2
	1	VW3A8306R10	235.000	2
IP20 CANopen junction boxes		VW3CANTAP2	5.970.000	2

Alat Konfigurasi

Deskripsi	Referensi	Harga (Rp) (Sebelum PPN)	SS
Simple Loader	VW3A8120	9.587.000	2
Multi Loader	VW3A8121	19.242.000	2

Remote Display Terminal

Deskripsi	Degree of Protection	Length (m)	Referensi	Harga (Rp) (Sebelum PPN)	SS
Remote Display Terminal	IP 54	-	VW3A1006	1.310.000	2
	IP 65	-	VW3A1007	2.785.000	2
Remote graphic display terminal			VW3A1101	4.863.000	2
Remote Cable		1	VW3A1104R10	372.000	2
		3	VW3A1104R30	535.000	1
		5	VW3A1104R50	688.000	2
		10	VW3A1104R100	1.020.000	2
Female/female RJ45 adaptor			VW3A1105	645.000	2



Scan QR untuk Data Teknis



ATV340U22N4
ATV340U22N4E

ATV340U75N4
ATV340U75N4E



ATV340D22N4
ATV340D22N4E

ATV340D37N4
ATV340D37N4E



- Setiap pembelian ATV340 tidak dilengkapi Display Terminal
- Remote display terminal dijual terpisah



VW3A1113

VW3A1113

Variable Speed Drive Altivar Machine ATV340

Altivar Machine ATV340

Untuk Motor Induksi 0.75 - 75 kW

Drives with Modular type

Motor Power ⁽¹⁾ (kW)	Arus Input pada Teg. Maksimum (A)	Arus Kontinue Maksimum (A)	Arus Transient Maksimum ⁽²⁾ (A)	Referensi	Harga (Rp) (Sebelum PPN)	SS
Tegangan Suplai 3 phase: 380...480 V 50/60 Hz, EMC filter terintegrasi						
0.75	2.6	2.2	3.3	ATV340U07N4	10.056.000	2
1.5	4.9	4	6	ATV340U15N4	11.595.000	2
2.2	6.6	5.6	8.4	ATV340U22N4	13.682.000	2
3	8.5	7.2	10.8	ATV340U30N4	14.783.000	2
4	10.6	9.3	14	ATV340U40N4	16.791.000	2
5.5	16	12.7	19.1	ATV340U55N4	22.970.000	2
7.5	20.4	16.5	24.8	ATV340U75N4	25.775.000	2
11	27.7	24	36	ATV340D11N4	32.711.000	2
18.5	43.4	39	59	ATV340D18N4	44.958.000	2

Drives with Ethernet type

Motor Power ⁽¹⁾ (kW)	Arus Input pada Teg. Maksimum (A)	Arus Kontinue Maksimum (A)	Arus Transient Maksimum ⁽²⁾ (A)	Referensi	Harga (Rp) (Sebelum PPN)	SS
Tegangan Suplai 3 phase: 380...480 V 50/60 Hz, EMC filter terintegrasi						
0.75	2.6	2.2	3.3	ATV340U07N4E	10.585.000	2
1.5	4.9	4	6	ATV340U15N4E	12.206.000	2
2.2	6.6	5.6	8.4	ATV340U22N4E	14.402.000	2
3	8.5	7.2	10.8	ATV340U30N4E	15.560.000	2
4	10.6	9.3	14	ATV340U40N4E	17.675.000	2
5.5	16	12.7	19.1	ATV340U55N4E	23.224.000	2
7.5	20.4	16.5	24.8	ATV340U75N4E	26.386.000	2
11	27.7	24	36	ATV340D11N4E	32.846.000	2
15	35.7	32	48	ATV340D15N4E	40.672.000	2
18.5	43.4	39	59	ATV340D18N4E	47.324.000	2
22	50.6	46	69	ATV340D22N4E	52.781.000	2
30	48.3	61.5	92.25	ATV340D30N4E	61.599.000	2
37	59	74.5	111.75	ATV340D37N4E	76.784.000	2
45	71.8	88	132	ATV340D45N4E	87.964.000	2
55	86.9	106	159	ATV340D55N4E	104.618.000	2
75	118.1	145	217.5	ATV340D75N4E	128.246.000	2

Catatan :

- Rating pada nameplate motor
- Untuk transient selama 60 detik
- Telah dilengkapi kemampuan komunikasi Modbus, CANopen

Remote Display Terminal

Deskripsi	Referensi	Harga (Rp) (Sebelum PPN)	SS
Plain Text Display Terminal	IP 21	VW3A1113	1.812.000 2
Mounting kit for display	IP 43	VW3A1114	423.000 2



Scan QR untuk Data Teknis



ATV212H075M3X



ATV212HD15N4



ATV212HD55N4

Variable Speed Drive Altivar Building ATV212

Altivar Building ATV212 - HVAC Drive⁽³⁾⁽⁵⁾

Untuk Motor Induksi 0.75 - 75 kW

Inverter dengan Tegangan Suplai 3 Fasa, 380 - 480 VAC

Motor Power ⁽¹⁾ (kW)	Arus Input pada Teg. Maksimum (A)	Arus Kontinue Maksimum (A)	Arus Transient Maksimum ⁽²⁾ (A)	Referensi	Harga (Rp) (Sebelum PPN)	SS
0.75	1.4	2.2	2.4	ATV212H075N4	9.580.000	2
1.5	2.5	3.7	4	ATV212HU15N4	11.196.000	2
2.2	3.6	5.1	5.6	ATV212HU22N4	12.816.000	2
3	4.9	7.2	7.9	ATV212HU30N4	14.482.000	2
4	6.4	9.1	10	ATV212HU40N4	15.140.000	2
5.5	8.6	12	13.2	ATV212HU55N4	18.230.000	2
7.5	11.7	16	17.6	ATV212HU75N4	21.353.000	1
11	16.8	22.5	24.8	ATV212HD11N4	26.320.000	1
15	22.8	30.5	33.6	ATV212HD15N4	31.857.000	1
18.5	27.8	37	40.7	ATV212HD18N4	38.973.000	2
22	33.1	43.5	47.9	ATV212HD22N4	49.064.000	2
30	44.7	58.5	64.4	ATV212HD30N4	51.965.000	2
37	54.4	79	86.9	ATV212HD37N4	63.706.000	2
45	65.9	94	103.4	ATV212HD45N4	77.130.000	2
55	89	116	127.6	ATV212HD55N4	92.564.000	2
75	111.3	160	176	ATV212HD75N4	102.835.000	2

Catatan :

- (1) Rating pada name plate motor
- (2) Untuk transient selama 60 detik
- (3) Semua rating ATV212 telah dilengkapi dengan EMC kelas A
ATV212 merupakan inverter dengan tingkat harmonik yang rendah (rata-rata THDi < 30%)
- (4) Telah dilengkapi kemampuan komunikasi Modbus, METASYS N2, APOGEE FLN, BACnet
- (5) Untuk ATV212 versi IP54, silakan menghubungi PT. Schneider Indonesia

Remote Display

Deskripsi	No pada gambar aksesori	Referensi	Harga (Rp) (Sebelum PPN)	SS
Remote Display Terminal	9	VW3A1101	4.863.000	2
Aksesori :				
▪ Kit untuk mounting remote	7	VW3A1102	1.492.000	2
▪ Pintu	10	VW3A1103	621.000	2
▪ Kabel Remote 1 meter	8	VW3A1104R10	372.000	2
▪ Kabel Remote 3 meter	8	VW3A1104R30	535.000	1
▪ Kabel Remote 5 meter	8	VW3A1104R50	688.000	2
▪ Kabel Remote 10 meter	8	VW3A1104R100	1.020.000	2
▪ Adaptor RJ45 female / female	6	VW3A1105	645.000	2

Modul Komunikasi ⁽⁴⁾

Deskripsi	Referensi	Harga (Rp) (Sebelum PPN)	SS
LONWORKS	VW3A21312	7.623.000	2



Scan QR untuk
Data Teknis



ATV630D15N4



ATV630D30N4



ATV630C25N4

Variable Speed Drive Altivar Process ATV630

Altivar Process ATV630

Untuk Motor Induksi 0.75 - 315 kW

Inverter dengan Tegangan Suplai 3 Fasa, 380 - 480 VAC

Motor Power ⁽¹⁾ (kW)	Arus Input pada Teg. Maksimum (A)	Arus Kontinue Maksimum (A)	Arus Transient Maksimum ⁽²⁾ (A)	Referensi	Harga (Rp) (Sebelum PPN)	SS
0.75	1.3	2.2	2.4	ATV630U07N4	27.883.000	2
1.5	2.6	4	4.4	ATV630U15N4	28.825.000	2
2.2	3.8	5.6	6.2	ATV630U22N4	29.547.000	2
3	5.1	7.2	7.9	ATV630U30N4	30.151.000	2
4	6.7	9.3	10.2	ATV630U40N4	30.984.000	2
5.5	9.1	12.7	14	ATV630U55N4	32.497.000	2
7.5	11.9	16.5	18.2	ATV630U75N4	37.543.000	2
11	17	23.5	25.9	ATV630D11N4	40.008.000	2
15	23.3	31.7	34.9	ATV630D15N4	46.903.000	2
18.5	28.9	39.2	43.1	ATV630D18N4	54.859.000	1
22	34.4	46.3	50.9	ATV630D22N4	62.406.000	2
30	45.9	61.5	67.7	ATV630D30N4	72.127.000	2
37	57.3	74.5	82	ATV630D37N4	86.986.000	2
45	69.1	88	96.8	ATV630D45N4	100.458.000	1
55	84.2	106	116.6	ATV630D55N4	118.839.000	2
75	112.7	145	159.5	ATV630D75N4	145.899.000	2
90	135.8	173	190.3	ATV630D90N4	169.339.000	2
110	165	211	232	ATV630C11N4	202.520.000	2
132	213	250	275	ATV630C13N4	234.778.000	2
160	262	302	332	ATV630C16N4	278.464.000	2
220	324	427	470	ATV630C22N4	348.074.000	2
250	366	481	529	ATV630C25N4	425.421.000	2
315	461	616	678	ATV630C31N4	489.881.000	2

Catatan :

(1) Rating pada nameplate motor

(2) Untuk transient selama 60 detik

(3) Untuk ATV600 versi IP55, Floor Standing, dan 3 fasa 220 VAC, silakan menghubungi PT. Schneider Indonesia



VW3A1111



VW3A3607

Pilihan dan Aksesori

Remote Display

Deskripsi	Referensi	Harga (Rp) (Sebelum PPN)	SS
Remote Graphic Display Terminal	VW3A1111	3.882.000	2
Aksesori :			
▪ Kit untuk mounting remote	VW3A1112	864.000	1
▪ Kabel Remote 3 meter	VW3A1104R30	535.000	1
▪ Kabel Remote 5 meter	VW3A1104R50	688.000	2

Modul Tambahan

Deskripsi	Referensi	Harga (Rp) (Sebelum PPN)	SS
Modul Komunikasi Untuk Tipe ATV630			
PROFIBUS DP V1	VW3A3607	11.238.000	2



Scan QR untuk
Data Teknis



ATV930D15N4



ATV930D55N4



ATV930C11N4C

Variable Speed Drive Altivar Process ATV930

Altivar Process ATV930

Untuk Motor Induksi 0.75 - 315 kW
(rating name plate untuk aplikasi Heavy Duty)

Motor Power ⁽¹⁾ (kW)	Arus Input pada Teg. Maksimum (A)	Arus Kontinue Maksimum (A)	Arus Transient Maksimum ⁽²⁾ (A)	Breaking Unit	Referensi	Harga (Rp) (Sebelum PPN)	SS
0,37	0,8	1,5	2,3	√	ATV930U07N4	29.420.000	2
0,75	1,5	2,2	3,3	√	ATV930U15N4	29.543.000	2
1,5	2,9	4	6	√	ATV930U22N4	29.784.000	2
2,2	4	5,6	8,4	√	ATV930U30N4	30.267.000	2
4	7,2	9,3	14	√	ATV930U55N4	33.576.000	2
5,5	9,2	12,7	19,1	√	ATV930U75N4	36.135.000	2
7,5	12,5	16,5	24,8	√	ATV930D11N4	43.179.000	2
11	18,1	23,5	35,3	√	ATV930D15N4	46.716.000	2
15	24,4	31,7	47,6	√	ATV930D18N4	57.338.000	2
18,5	29,9	39,2	58,8	√	ATV930D22N4	70.081.000	2
22	35,8	46,3	69,5	√	ATV930D30N4	78.164.000	2
30	48,3	61,5	92,3	√	ATV930D37N4	96.788.000	2
37	59,0	74,5	111,8	√	ATV930D45N4	111.298.000	2
45	71,8	88	132	√	ATV930D55N4	129.750.000	2
55	86,9	106	159	√	ATV930D75N4	163.261.000	2
75	118,1	145	217,5	√	ATV930D90N4	187.328.000	2
90	243	173	259,5	√	ATV930C11N4	256.812.000	2
110	165	211	317	√	ATV930C13N4	301.620.000	2
132	213	250	375	√	ATV930C16N4	337.958.000	2
160	246	302	453	√	ATV930C22N4	370.538.000	2

Motor Power ⁽¹⁾ (kW)	Arus Input pada Teg. Maksimum (A)	Arus Kontinue Maksimum (A)	Arus Transient Maksimum ⁽²⁾ (A)	Breaking Unit	Referensi	Harga (Rp) (Sebelum PPN)	SS
45	71,8	88	132	x	ATV930D55N4C	119.060.000	2
55	86,9	106	159	x	ATV930D75N4C	137.376.000	2
75	118,1	145	217,5	x	ATV930D90N4C	162.234.000	2
90	143	173	259,5	x	ATV930C11N4C	215.275.000	2
110	165	211	270	x	ATV930C13N4C	258.905.000	2
132	213	250	360	x	ATV930C16N4C	297.270.000	2
160	286	302	452	x	ATV930C22N4C	352.890.000	2
200	353	370	555	x	ATV930C25N4C	415.306.000	2
250	432	477	716	x	ATV930C31N4C	494.525.000	2

Catatan :

- (1) Rating pada name plate motor, untuk aplikasi Heavy Duty dimana membutuhkan overload yang signifikan (hingga 150%).
- (2) Untuk transient selama 60 detik.
- (3) Untuk ATV900 versi IP55, Floor Standing, dan 3 fasa 240 VAC, silakan menghubungi PT. Schneider Indonesia.
- (4) Disuplai Dalam bentuk IP 00 untuk mounting didalam enclosure. Untuk IP 21/UL Type 1 wall mounting, conformity kit harus dipesan terpisah.



VW3A1111

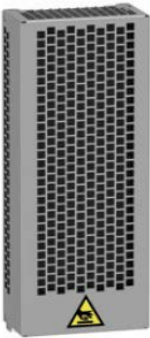

VW3A7730



ATVRD15N4

Variable Speed Drive Altivar Process ATV930

Pilihan dan Aksesori

Remote Display

Deskripsi	No pada gambar aksesori	Referensi	Harga (Rp) (Sebelum PPN)	SS
Remote Graphic Display Terminal	1	VW3A1111	3.882.000	2
Aksesori :				
▪ Kit untuk mounting remote	2	VW3A1112	864.000	1
▪ Kabel Remote 3 meter	4	VW3A1104R30	535.000	1
▪ Kabel Remote 5 meter	4	VW3A1104R50	688.000	2

Braking Resistor

Untuk Referensi Drive	Nilai Ohm	Daya (kW)	Referensi	Harga (Rp) (Sebelum PPN)	SS
ATV930U07N4...U15N4	100	0.1	VW3A7730	1.986.000	2

Altivar Regenerative Units

Fungsi utama produk adalah untuk memberikan pilihan meregenerasi energi yang mudah diatur untuk pengaplikasian pada pengereman berat seperti pengerjaan material, penanganan material, dan pengangkatan.

Deskripsi	IP	Referensi	Harga (Rp) (Sebelum PPN)	SS
Supply voltage: 380...480 V 50/60 Hz				
Merujuk kepada. Pilih Regenerative Unit	20	ATVRU75N4	17.085.000	2
	20	ATVRD15N4	19.637.000	2

*) Pilihan produk ini berkaitan dengan Altivar ATV930...N4, ATV950...N4 dan ATV320...N4

***) Kinerja penggunaan unit pengereman akan sama dengan drives standar



Scan QR untuk
Data Teknis



ATV310H037N4E



ATV310HU75N4E



ATV310HD18N4EF



ATV310HD22N4EF

Variable Speed Drive Easy Altivar ATV310

Easy Altivar ATV310

Untuk Motor Induksi 0.37 - 11 kW

■ Tegangan Suplai 3 phasa 380 - 460 VAC 50/60Hz

Motor Power ⁽¹⁾	Arus Input pada Teg. Maksimum ⁽²⁾	Arus Kontinue Maksimum ⁽¹⁾	Arus Transient Maksimum ⁽³⁾	Referensi	Harga (Rp) <i>(Sebelum PPN)</i>	SS
(kW)	(A)	(A)	(A)			
0.37	1,8	1.5	1.5	ATV310H037N4E	4.208.000	1
0.75	3,1	2.3	2.3	ATV310H075N4E	4.348.000	1
1.5	5,4	4.1	4.1	ATV310HU15N4E	4.941.000	1
2.2	7,2	5.5	5.5	ATV310HU22N4E	5.764.000	1
3	9,2	7.1	7.1	ATV310HU30N4E	6.349.000	2
4	11,4	9.5	9.5	ATV310HU40N4E	7.040.000	1
5.5	14,3	12,6	12,6	ATV310HU55N4E	9.818.000	1
7.5	22,4	17	17	ATV310HU75N4E	11.080.000	1
11	30,4	24	24	ATV310HD11N4E	14.160.000	1

Easy Altivar ATV310 Extension

Untuk Motor Induksi 15 - 22 kW dengan opsi **EMC Filter**

■ Tegangan Suplai 3 phasa 380 - 460 VAC 50/60Hz

Motor Power ⁽¹⁾	Arus Input pada Teg. Maksimum ⁽²⁾	Arus Kontinue Maksimum ⁽¹⁾	Arus Transient Maksimum ⁽³⁾	EMC Filter	Referensi	Harga (Rp) <i>(Sebelum PPN)</i>	SS
(kW)	(A)	(A)	(A)				
15	20	33	49,5	x	ATV310HD15N4E	18.332.000	2
15	20	33	49,5	√	ATV310HD15N4EF	20.080.000	2
18	25	39	58,5	x	ATV310HD18N4E	22.124.000	2
18	25	39	58,5	√	ATV310HD18N4EF	24.336.000	2
22	30	46	69	x	ATV310HD22N4E	26.650.000	2
22	30	46	69	√	ATV310HD22N4EF	29.314.000	2

Catatan :

- (1) Rating Daya Motor untuk maksimum frekuensi 4kHz. Di atas 4kHz ada derating
- (2) Tegangan maksimum yang dimaksud adalah 460 untuk 380-460 VAC



Scan QR untuk
Data Teknis



ATV610U07N4



ATV610D18N4



ATV610C11N4

Variable Speed Drive Easy Altivar ATV610

Easy Altivar ATV610

Untuk Motor Induksi 0.75 - 160 kW

Motor Power ⁽¹⁾	Arus Input pada Teg. Maksimum ⁽²⁾	Arus Kontinue Maksimum ⁽¹⁾	Arus Transient Maksimum ⁽²⁾	Referensi	Harga (Rp) <i>(Sebelum PPN)</i>	SS
(kW)	(A)	(A)	(A)			
0.75	2.9	2.2	2.4	ATV610U07N4	19.812.000	2
1.5	5.3	4.0	4.4	ATV610U15N4	22.393.000	2
2.2	7.1	5.6	6.2	ATV610U22N4	22.513.000	2
3	9.2	7.2	7.9	ATV610U30N4	22.698.000	2
4	8.5	9.3	10.2	ATV610U40N4	22.729.000	2
5.5	11.0	12.7	14.0	ATV610U55N4	22.876.000	2
7.5	13.7	15.8	17.4	ATV610U75N4	23.096.000	2
11	20.7	23.5	25.9	ATV610D11N4	24.348.000	2
15	27.7	31.7	34.9	ATV610D15N4	25.340.000	1
18.5	35.2	39.2	43.1	ATV610D18N4	30.217.000	2
22	39.0	46.3	50.9	ATV610D22N4	35.169.000	1
30	59.7	61.5	67.7	ATV610D30N4	47.267.000	1
37	72.9	74.5	82.0	ATV610D37N4	57.736.000	1
45	88.3	88	97	ATV610D45N4	66.897.000	2
55	105.6	106	117	ATV610D55N4	79.419.000	2
75	139.0	145	160	ATV610D75N4	94.754.000	1
90	168.5	173	190	ATV610D90N4	135.662.000	2
110	165.0	211	232	ATV610C11N4	146.684.000	1
132	213.0	250	275	ATV610C13N4	167.629.000	1
160	261.0	302	332	ATV610C16N4	188.865.000	2

Catatan :

- (1) Rating pada nameplate motor
- (2) Untuk transient selama 60 detik

Kantor Pusat Schneider Electric Indonesia

Kantor Pusat Schneider Electric Indonesia kini resmi berpindah lokasi ke Cibis-9 Building. Dengan mengusung konsep “Workplace of The Future”, kantor pintar ini merupakan bagian dari strategi transformasi digital perusahaan dalam memberikan pengalaman terbaik bagi staf, mitra, pemasok, dan klien. Kantor dengan luas 2.300 meter persegi ini mengadopsi ruang kerja terbuka (open-plan office) dengan 30 persen dari luas kantor didedikasikan sebagai ruang kolaborasi yang memberikan fleksibilitas untuk meningkatkan produktivitas dan kolaborasi antarstaf.

Kantor pintar ini juga digunakan sebagai pusat pembelajaran berbagai inovasi dan teknologi terbaru dalam pengelolaan energi serta otomasi melalui fasilitas Innovation Hub dan Live Data Center. Melalui konsep dan fasilitas tersebut, Schneider Electric berharap dapat memberikan wawasan dan pengalaman yang lebih baik terhadap produk dan solusi EcoStruxure dari Schneider Electric.





Ecostruxure Plant
Mastering the digital future of industry

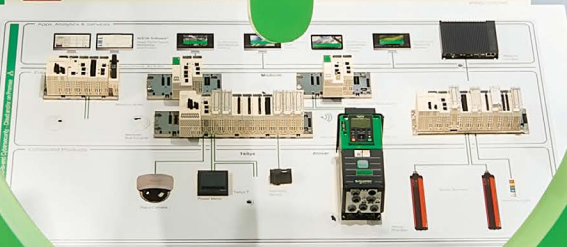

Ecostruxure Building Operation

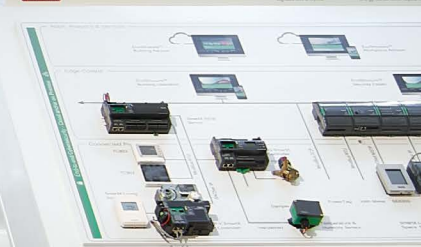

Medan

UNIPLAZA Building, East Tower, Lt 3
Jl. Letjend. M.T. Haryono A-1
Medan - 20231
Ph. (62) (061) 457 9006
Fax. (62) (061) 455 5153

Batam

Batamindo Industrial Park
Jl. Beringin Blok 4
Muka Kuning, Batam Island - 29433
Ph. (62) (0770) 611 133
Fax. (62) (0770) 611 134

Balikpapan

Komplek Ruko Little China Blok AB 6 No 7,
Balikpapan Baru Balikpapan 76114,
Kalimantan Timur
Ph. (0542)-876722
Fax.(0542)-873709

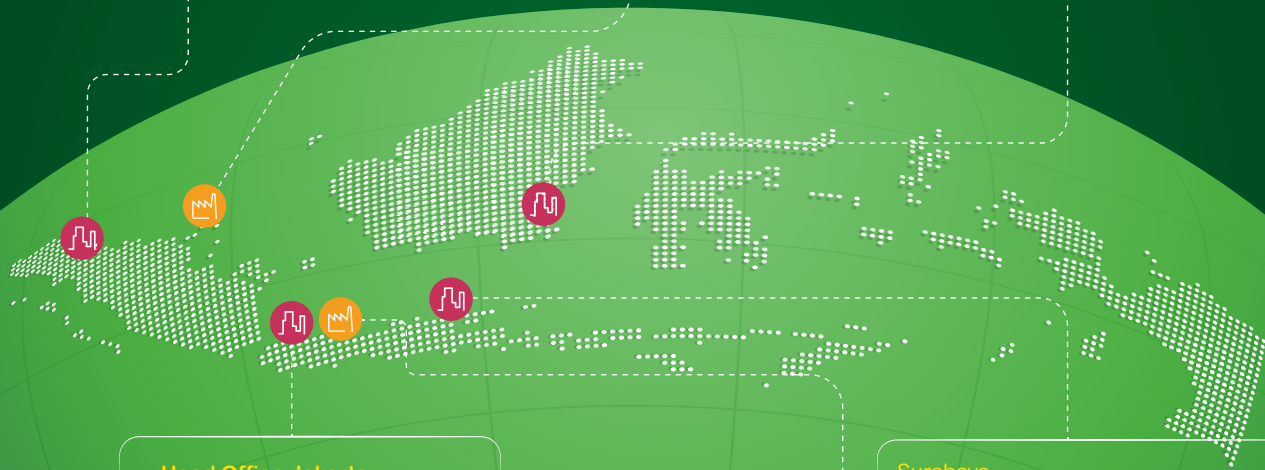

Head Office Jakarta

Gedung Cibis Nine Park, 16th Floor
Jalan TB Simatupang No. 2,
Cilandak Timur, Jakarta Selatan
DKI Jakarta - 12560
Ph. (021) 5096 6000

Surabaya

Gedung Graha Pena Lt. 3 Ruang 302
Jl. Jendral A. Yani no 88, Surabaya 60234
Ph. (62) (031) 8288333 (Hunting)
Fax. (62) (031) 8299901

APC By Schneider Electric

Gedung Cibis Nine Park, 16th Floor
Jalan TB Simatupang No. 2,
Cilandak Timur, Jakarta Selatan
DKI Jakarta - 12560
Ph. (021) 5096 6000

Cikarang

East Jakarta Industrial Park (EJIP)
Plot 4B no.1-2, Lemah Abang
Bekasi 17550, Jawa Barat
Ph. (62) (21) 897 0203-8
Fax. (62) (21) 897 0209, 897 0085



Scan this QR
Code for our
partner location



Sales Office



Factory

CUSTOMER CARE CENTER

Sejak tahun 1999, PT Schneider Indonesia sangat menyadari pentingnya peranan Customer Care Center dalam menunjang dan meningkatkan pelayanan kepuasan pelanggan seiring dengan visi perusahaan.

Customer Care Center secara terus menerus mengembangkan dan meningkatkan kemampuan para karyawan serta perangkat lunak dan perangkat keras sehingga kami dapat melayani seluruh pelanggan di wilayah nusantara.

Unduh aplikasi mySchneider dengan QR Code scanning. Silakan akses aplikasi untuk :

- Informasi stock barang
- Informasi umum tentang produk
- Informasi harga

PELAYANAN

- Informasi Status Pesanan Barang
- Spesifikasi Produk
- Aplikasi Teknik
- Online Trouble Shooting
- Keluhan Pelanggan



Available on:



Life Is On

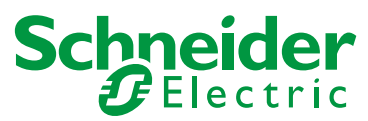

Life Is On

Schneider
Electric

Hotline

1500055

F. (+62) (21) 750 4415-16

E. customercare.id@se.com

se.com/id