

Life Is On

Schneider
Electric



Pricebook Retail 2024



Tahun 2019

Perusahaan yang paling dikagumi di Dunia.

– dari Fortune, untuk Industri Elektronik

Schneider Indonesia berdiri sejak

1973 | 51 Tahun

Pemimpin Industri

Dalam Indeks Dow Jones Sustainability (DJSI) selama 3 tahun berturut-turut dan "Industry Motver" untuk kemajuan proporsional terbaik pada performa keberlanjutannya dari tahun lalu.

Schneider Electric

~137.000

Karyawan di 100+ Negara

♀ 30%
Karyawan kami adalah wanita



Infrastruktur

Menciptakan jaringan distribusi di seluruh Indonesia

4 Bisnis yang Terintegrasi & Sinergis



40%
Building
Partner



29%
Industri



17%
Infra-
struktur



14%
Information
Technology

5%

dari Pendapatan
disalurkan untuk Riset
& Pengembangan

45%

Pendapatan
dari IoT

42%

Pendapatan dari
Ekonomi Baru

Sebagai **pemimpin global di transformasi digital** untuk manajemen energi dan otomasi, kami menciptakan teknologi terhubung yang



Membentuk
Kembali
Industri



Memperkaya
Hidup



Mengubah
Perkotaan

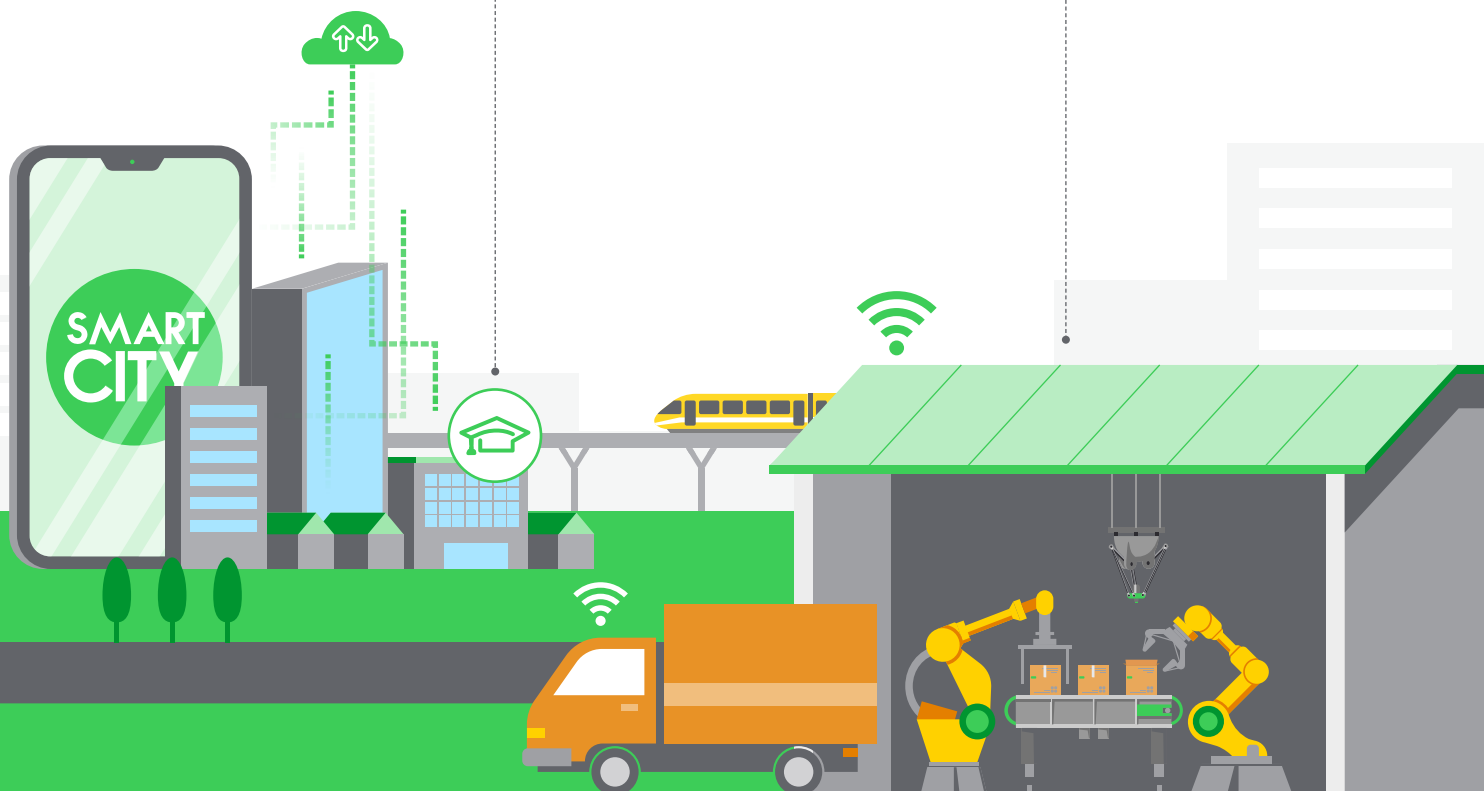

€26 Miliar
Pendapatan 2018

€3.9 Miliar
EBITDA yang disesuaikan 2018

Daftar Isi

Infografik

Daftar Isi

AvatarOn

Sakelar Dengan Personalisasi Cover



Leona

Sakelar Untuk Semua Rumah



USB Charger

Definisikan Ulang Zona Nyaman Anda



ZENCelo

Vivace, Pieno, ZENCelo, Neo, AvatarON



Pieno

Sakelar Dan Kotak Kontak Datar Pertama Di Dunia



Vivace

Kombinasi Sempurna Antara Estetika Dan Performa



S-Classic

Desain Tak Lekang Waktu



Kavacha

Perlindungan Sepanjang Waktu



Argus

Occupancy Sensor



Neo

Sakelar Dan Kotak Kontak Horizontal Dengan Teknologi Led



Domae

Pilihan Terbaik



RCCB



Mini Pragma

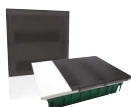

GoPact MCCB



EasyPact CVS



ComPact NSX



Industrial Plug Socket

Performa Tinggi Sesuai Dengan Standar IEC Serta Mudah Diinstal



Easy TeSys

Kontaktor Dengan Kemampuan Beroperasi 1,4 Juta Kali



EasyLogic



Harmony Push Button & Signaling





AvatarOn

Sakelar dengan personalisasi cover

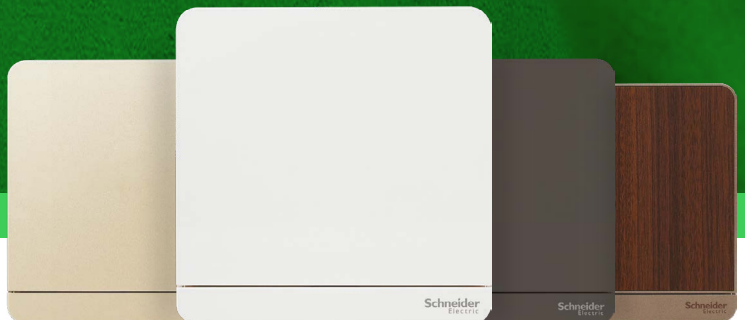



Sakelar AvatarOn tidak mengganggu di siang hari dan berpendar di malam hari.

LED Locator

Dilengkapi dengan LED Locator yang berpendar lembut.



Innovative Interchangeable Cover

Inovasi Desain dan Teknologi

Pada 2017, AvatarOn mendapatkan penghargaan Desain iF yang bergengsi, salah satu dari keunggulan desain, kualitas, dan kepercayaan desain yang paling diakui dan diakui dunia.

Dengan SS Mechanism Switch, sudut sakelar hanya 3 derajat, menghasilkan suara yang halus dan mengurangi resiko terjadinya loncatan api listrik.

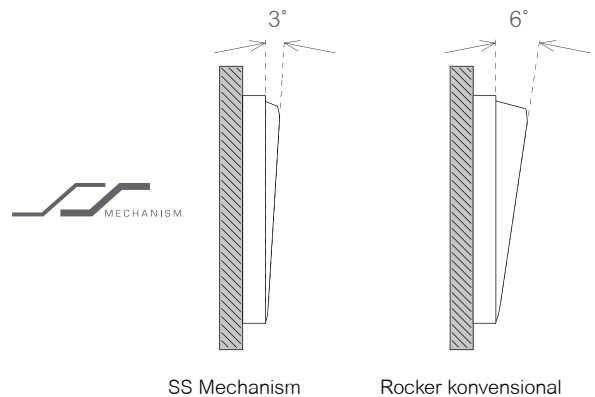



Jenis	Gambar	Keterangan	Referensi	WE*	WG*	DG*	WD*
				Harga (Sebelum PPN)			
SAKELAR HORIZONTAL		16AX 250V 1G 1W Sw w LED,	E8331L1LED_**_G3	90.200	117.300	117.300	153.100
		16AX 250V 1G 2W Sw w LED,	E8331L2LED_**_G3	114.400	132.600	132.600	172.600
		16AX 250V 2G 1W Sw w LED,	E8332L1LED_**_G3	128.500	160.900	160.900	209.800
		16AX 250V 2G 2W Sw w LED,	E8332L2LED_**_G3	174.100	200.900	200.900	231.700
		16AX 250V 3G 1W Sw w LED,	E8333L1LED_**_G3	177.300	204.700	204.700	266.500
		16AX 250V 3G 2W Sw w LED,	E8333L2LED_**_G3	202.000	233.400	235.700	-
		4A 250V 3G Momentary Sw,	E8333PRL1_**_G3	-	-	205.300	-
		16AX 250V 4G 1W Sw w LED,	E8334L1LED_**_G3	193.600	222.700	222.700	321.800
		16AX 250V 4G 2W Sw w LED,	E8334L2LED_**_G3	-	251.200	251.200	-
SAKELAR BEL		10A 250V 1G BP Sw	E8331BPL1_**_G3	-	-	253.800	-
DIMMER		1G 250VA Dimmer w Sw	E8331RD250_**	514.800	669.500	669.500	861.700
STOP KONTAK		16A Schuko Socket	E83426_16S_**_G3	116.000	133.400	133.400	154.000
		16A250V1Gang international Skt	E83426TS_**	222.200	363.500	363.500	473.300
		13A 250V 1G SW Skt w LED	E8315N_**	143.800	175.500	175.500	196.500
STOP KONTAK DATA, TV, TELP		1G TV Socket 75Ohm Through-Connect	E8331TV_**	115.400	150.700	150.700	173.900
		1G TEL Socket Shuttered Wallplate	E8331RJS4_**	114.300	149.400	149.400	170.900
		1G RJ45 Data CAT5E Shuttered	E8331RJS5_**	116.400	150.500	152.000	173.400
		1G RJ45 Data CAT6 Shuttered	E8331RJS6_**	118.500	154.400	154.400	176.000
STOP KONTAK HDMI		HDMI + USB SOCKET (Media)	E8332HDUSB_**	463.400	634.300	634.300	-
		2G HDMI + HDMI KEYSTONE	E8332HDHD_**	596.700	825.000	833.000	-
USB CHARGER		16A Int Socket with 2.1A USB	E8342616USB_**	579.300	666.200	666.200	765.100
		2 x 2.1A USB Charger	E8332USB_**	963.900	1.178.500	1.178.500	1.342.700
		21W Type A+C, PD+QC3.0 USB Charger	E8332ACQUSB_**	1.157.100	1.333.600	-	1.733.100
AKSESORI HOTEL		DND, PCU, PW Ind w Bell SW	E8331BPDMW_**	248.600	-	289.700	-
		16AX 3G Sw with PCU, DND, PW Sym	E8333DMWS_**	255.000	-	-	-
		250V 16A Elec Keycard SW w ID	E8331EKTID_**	-	-	1.657.700	-
		250V 16A Elec Keycard SW	E8331EKT_**	730.600	786.700	786.700	896.200
		115/240V 20VA Uni Ver Shaver	E83T727V_**	885.800	1.018.900	1.018.900	1.161.800



Jenis	Gambar	Keterangan	Referensi	WE*	WG*	DG*	WD*
				Harga (Sebelum PPN)			
BLANK PLATE & SWITCH COVER		1G Blank Plate	E8330X_**	44.400	51.600	51.600	89.300
		1G Sw Cover	E8331_**	45.900	67.000	67.000	128.800
		1G Sw Cover w Keyholder	E8331KH_**	56.100	-	-	-
		2G Sw Cover	E8332_**	56.100	70.200	69.500	167.300
		3G Sw Cover	E8333_**	61.300	88.900	88.000	-
		4G Sw Cover	E8334_**	67.000	81.400	81.400	229.500
FRAME		2G Bracket	E8331_26_**	42.900	68.700	68.700	102.200
		3G Bracket	E8331_36_**	53.600	76.500	77.200	-
		4G Bracket	E8331_46_**	64.400	89.300	89.300	-
		5G Bracket	E8331_56_**	-	-	108.900	-

Kualitas Material Superior



Berbahan baku kualitas tinggi dengan proteksi anti UV sehingga warna terlindungi, tahan lama serta tidak berubah warna seiring dengan berjalannya waktu



Menggunakan material Bayer PC (Polycarbonate) yang tahan banting, tahan panas, tidak merambatkan api serta anti karat.



Pengamanan tambahan: memastikan kualitas operasional



Material dengan standar CCC, BS dan SNI, serta telah memenuhi Pedoman Pembatasan Bahan Berbahaya (RoHS)



Pemasangan serta peroperasian mudah





Leona

Sakelar untuk semua rumah



Performa maksimal untuk rumah Anda



- Frame modul terbuat dari logam, menjamin kualitas, kekuatan, dan tahan lama.
- Cakar terlindungi, menjamin kekuatan dan daya cengkram pada inbowdoost, sehingga bertahan lebih lama.
- Modul terbuat dari *Polycarbonate* berkualitas, lebih aman karena lebih tahan panas.



Dua cara pemasangan mudah, sistem pencakar atau sekrup



Konstruksi mekanikal kuat dan tahan lama



Desain stylish dan minimalis

Dua Cara Pemasangan

Menggunakan 2 pilihan cara pemasangan, dengan sistem pencakar atau sekrup.

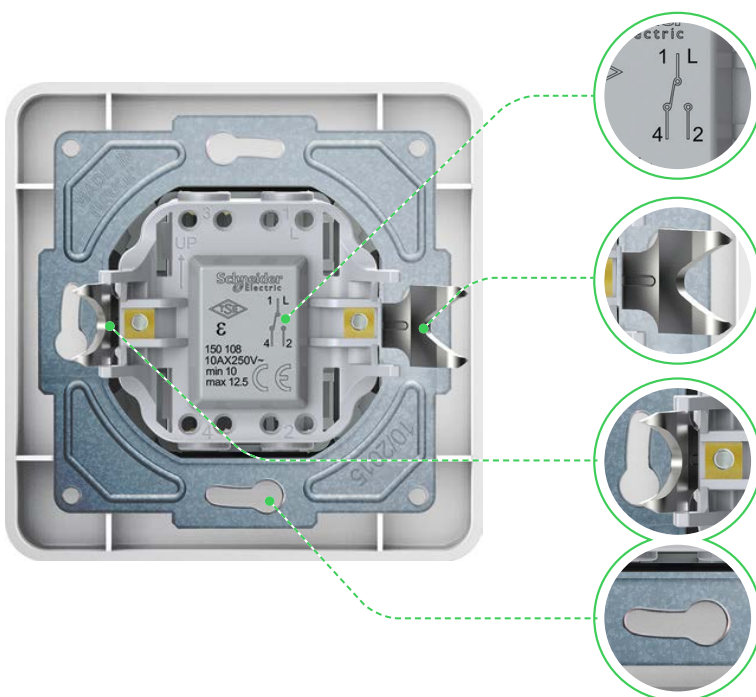

Instruksi lengkap

Diagram perkabelan tercetak di bagian dalam produk.

Cakar penahan yang kuat

bagian pencakar yang optimal untuk pemasangan yang kuat.

Pemasangan yang mudah

Disesuaikan dengan kebutuhan Anda. Pemasangan bisa dilakukan dengan sistem sekrup dan pencakar.

Jenis	Keterangan	Referensi	Pak	Harga (Sebelum PPN)
SAKELAR	10AX Sakelar 1 Gang - 1 Arah	LNA0100321	10	19.300
	10AX Sakelar 1 Gang - 2 Arah	LNA0400321	10	24.800
	10AX Sakelar 2 Gang - 1 Arah	LNA0300321	10	23.600
	10AX Sakelar 2 Gang - 2 Arah	LNA0600321	10	36.400
	10AX Sakelar 3 Gang - 1 Arah	LNA2100321	10	39.900
	10AX Sakelar Perantara (Intermediate)	LNA0500321	10	64.500
	16AX 1 Gang Sakelar Bel dengan indikator	LNA0800321	10	40.300
KOTAK KONTAK	16A 1 Gang Kotak Kontak Tipe Schuko tanpa Child Protection	LNA2900121	10	19.300
	16A 1 Gang Kotak Kontak Tipe Schuko dengan Child Protection	LNA2900221	10	23.600
	2 GANG SCHUKO CP	LNA9100221	6	53.700
	Frame Double dengan 1 Schuko CP + Kosong	LNA9000221	9	31.400
	Frame Triple dengan 1 Schuko CP + 2 Kosong	LNA9200221	7	33.900
STOP KONTAK DATA, TV, TELEPON	Stop Kontak TV	LNA3200121	10	51.100
	Stop Kontak Telepon	LNA4100121	10	53.200
	Stop Kontak Data RJ45 Cat 5	LNA4300121	10	67.700
	Stop Kontak Data RJ45 Cat 6	LNA4700121	10	84.000
AKSESORIS HOTEL & LAINNYA	Energy Saver Card Hotel	LNA1900221	8	216.900
	2 Gang USB Charger Max 2.1a	LNA4500121	10	271.000
	2 Gang Universal Frame	LNA5800221	25	9.600
	3 Gang Universal Frame	LNA5800321	15	12.100
	1 Gang Outbow Leona	OBL838348	-	12.000



Box, Aksesori dan Floor Socket



- Tersedia dalam 2 pilihan material Aluminium dan Kuningan (Brass)
- Berbagai pilihan dan kombinasi modul, termasuk untuk telekomunikasi
- Dilengkapi dengan Floor Box
- Daya tahan tinggi
- Konstruksi kuat
- IP44

Gambar	Keterangan	Referensi	Pak	Harga (Sebelum PPN)
Box dan Aksesori				
	1 Gang Outbow Leona	OBL838348	1	12.000
	Wall Box, Black	SWB_727245	1	4.300
	Mounting Box W/O Term	E238	1	29.800
	2 Gang Surface Mount Polycarb Wallbox	E238_2	1	69.000
	2 Gang DP Mount'g Box	ET238D	1	80.700
Floor Socket				
	Empty Floor Skt W/ Box, IP44, DPG, Silver Color	E227F_ABE	1	562.900
	Empty Floor Skt W/ Box, IP44, DPG, Brass Colo	E227F_BAS	1	641.800
S-Flexi				
	Universal Socket 3 Pin 13A, 250V, Size M	F1426UAM	32	44.300
	Universal Socket 2 Pin 10 A, 250 V, Size M	F1426USM	32	56.100
	Universal Socket 2 Pin 10 A, 250 V Size S	F30426USM	30	35.700
	TV Koaksial Socket	F50TVM	30	53.500
	TV Koaksial Socket	F30TVSM_WE	30	114.000
	4PIN RJ11 TEL Socket, Tanpa Penutup	F30R4M	30	63.300
	CAT5E Data Communication, Tanpa Penutup	F30RJ5EM	30	84.600

Dimensi:

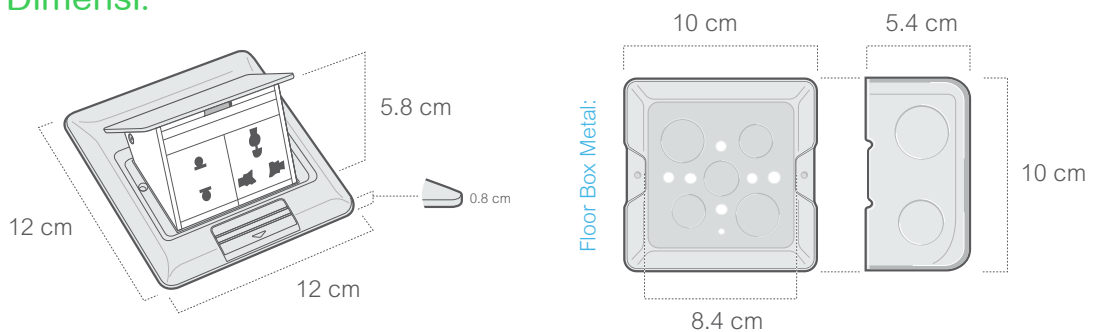



USB Charger Range

Vivace, Pieno, Zencelo,
Neo, AvatarOn



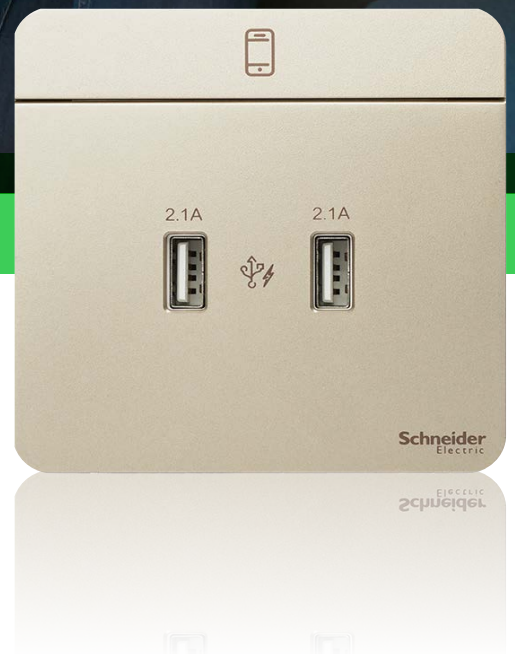

Proses Charging Cepat

Output 2.1A per outlet, 2 Gang USB max 4.2A.
Tersedia Quick charge Type A + C QC - 21 W Max.

Energy Efficiency

Fitur keamanan dan perlindungan memastikan pengisian daya ke gadget Anda aman & Efisien.

Fitur Perlindungan



Perlindungan terhadap panas berlebih





Perlindungan terhadap arus tidak stabil



Perlindungan terhadap tegangan tidak stabil

USB Charger Type A Warna Putih (Body Putih, LED Putih)

2.1 A Fast charging setiap Modulnya

Jenis	Gambar	Family - Warna	Referensi	Harga (Sebelum PPN)
1 Gang USB Chargers 2.1A		Vivace	KB31USB_WE	393.600
		Pieno, Putih	E8231USB_WE	494.000
		Pieno, Lavender Silver	E8231USB_LS	544.100
		Zencelo, Putih	E8431USB_WE	699.900
		Zencelo, Silver Bronze	E8431USB_SZ	683.300
		Neo, Putih	E3031USB_WW	1.031.600
		Neo, Grey Silver	E3031USB_GS	778.500
2 Gang USB Chargers 2 x 2.1A		Vivace	KB32USB_WE	819.400
		Pieno, Putih	E8232USB_WE	979.000
		Pieno, Lavender Silver	E8232USB_LS	1.051.600
		Zencelo, Silver Bronze	E8432USB_SZ	1.274.300
		AvatarOn, Putih	E8332USB_WE	963.900
		AvatarOn, Wine Gold	E8332USB_WG	1.178.500
		AvatarOn, Dark Grey	E8332USB_DG	1.178.500
		AvatarOn, Dark Wood	E8332USB_WD	1.342.700

International Socket + 2.1 A USB

Jenis	Gambar	Family - Warna	Referensi	Harga (Sebelum PPN)
International Socket + 2.1 A USB		Vivace	KB42616USB_WE	471.700
		Pieno, Putih	E8242616USB_WE	520.200
		Pieno, Lavender Silver	E8242616USB_LS	585.300
		AvatarOn, Putih	E8342616USB_WE	579.300
		AvatarOn, Wine Gold	E8342616USB_WG	666.200
		AvatarOn, Dark Grey	E8342616USB_DG	666.200
		AvatarOn, Dark Wood	E8342616USB_WD	765.100

Charger USB Type A + C

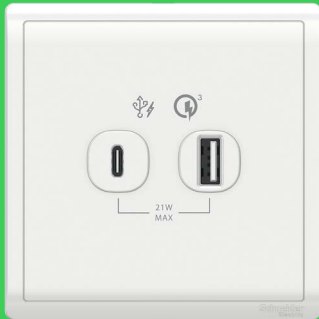

- Soket USB pertama dan satu-satunya yang terdaftar di Qualcomm “Wall-mounted QC USB” (Qualcomm Quick Charge Technology Device List version 03/2019)
- Ketika Soket Type A telah selesai mengisi ulang daya, soket Type C akan secara otomatis mengubah isi ulang daya menjadi “Fast Charge” (Schneider Electric patented).
- Type A or Type C alone, 5V 3A, 9V 2A, 12V 1.5A
- Type A and Type C, 5V 2.4A Max for every port

Type A + C QC - 21 W Max

Jenis	Gambar	Family - Warna	Referensi	Harga (Sebelum PPN)
Type A + C QC - 21 W Max		Vivace	KB32ACQUSB_WE	826.600
		AvatarOn, Putih	E8332ACQUSB_WE	1.157.100
		AvatarOn, Wine Gold	E8332ACQUSB_WG	1.333.600
		AvatarOn, Dark Wood	E8332ACQUSB_WD	1.733.100



ZENcelo

Sakelar dan kotak kontak datar pertama di dunia



Sakelar datar pertama di dunia

- Mekanisme 'impress' (iso-motion-press) yang telah dipatenkan memastikan bingkai sakelar tetap statis, baik ketika dalam posisi 'ON' atau 'OFF'.
- Sakelar diuji sebanyak 80.000 kali (2 kali lebih banyak dari standar internasional).



























Penggunaan penanda cahaya fluorescent white on white sebagai salah satu fitur eksklusif dari ZENcelo.

Kualitas & Keamanan yang Dirancang Tahan Lama

- Setiap bagian dilindungi oleh lapisan *polyurethane* untuk menjamin reabilitas produk.
- Terbuat dari material *polycarbonate* tahan karat, panas, serta benturan



Jenis	Gambar	Keterangan	Referensi	Pak	Harga (Sebelum PPN)
SAKELAR		16AX Sakelar Datar 1 Gang 1 Arah dengan Indikator, Putih	E8431_1_WE_G3	8	65.600
		16AX Sakelar Datar 1 Gang 2 Arah, Putih	E8431_2_WE_G3	8	114.900
		16AX Sakelar Datar 2 Gang 1 Arah dengan Indikator, Putih	E8432_1_WE_G3	8	103.700
		16AX Sakelar Datar 2 Gang 2 Arah, Putih	E8432_2_WE_G3	8	173.700
		16AX Sakelar Datar 3 Gang 1 Arah dengan Indikator, Putih	E8433_1_WE_G3	8	183.900
		16AX Sakelar Datar 3 Gang 2 Arah, Putih	E8433_2_WE_G3	8	282.600
		16AX 4 Gang 1 Arah Sakelar Datar dengan Indikator, Putih	E8434_1_WE_G3	8	231.900
		20A 1 Gang Sakelar Ganda Datar Neon, Putih	E8431D20_WE	8	256.200
KOTAK KONTAK		16A 1 Gang Kotak Kontak Tipe Schuko, Putih	E84426_16S_WE_G3	6	79.800
		16A 2 Gang Kotak Kontak Tipe Schuko, Putih	E84T426_16S_WE_G3	4	125.300
		16A 1 Gang Kotak Kontak Internasional, Putih	E84426_16TS_C15426	8	169.800
		13A 1 Gang Kotak Kontak dengan Sakelar, Neon, Putih	E8415N_WE_G11	8	218.600
USB CHARGER		1 x 2.1A USB Charger, WE	E8431USB_WE	8	699.900
PLAT PENUTUP		1 Gang Plat Penutup, Putih	E8430X_WE	12	56.200
KOTAK KONTAK TV, TELEPON DAN DATA		1 Gang Kotak Kontak Soket TV, Master, Putih	E8431TVM_WE	8	276.000
		1 Gang Kotak Kontak RJ11 4 Kawat Telepon Dengan Penutup, Putih	E8431RJS4_WE	8	320.900
		1 Gang Kotak Kontak RJ45 Data Outlet Cat 6, Putih	E8431RJ_6_WE	8	388.300
PEREDUP LAMPU		1 Gang 350VA, 50Hz Peredup Lampu (Dimmer) Datar Universal LED, Putih	E8431EPD4_WE	6	1.298.800
AKSESORI HOTEL		Universal Shaver Unit, Vertical	E84T727V_WE	1	1.051.300

Jenis	Gambar	Keterangan	Referensi	Pak	Harga (Sebelum PPN)
SAKELAR		16AX Sakelar Datar 1 Gang 1 Arah dengan Indikator, Silver Bronze	E8431_1_SZ_G3	8	120.000
		16AX Sakelar Datar 1 Gang 2 Arah, Silver Bronze	E8431_2_SZ_G3	8	167.600
		16AX Sakelar Datar 2 Gang 1 Arah dengan Indikator, Silver Bronze	E8432_1_SZ_G3	8	160.900
		16AX Sakelar Datar 2 Gang 2 Arah, Silver Bronze	E8432_2_SZ_G3	8	215.300
		16AX Sakelar Datar 3 Gang 1 Arah dengan Indikator, Silver Bronze	E8433_1_SZ_G3	8	228.700
		16AX 4 Gang 1 Arah Sakelar Datar dengan Indikator, Silver Bronze	E8434_1_SZ_G3	8	266.000
		20A 1 Gang Sakelar Ganda Datar Neon, Silver Bronze	E8431D20_SZ	8	196.700
		10A Sakelar Bel Datar, Silver Bronze	E8431BP1_SZ	10	430.200
KOTAK KONTAK		16A 1 Gang Kotak Kontak Tipe Schuko, Silver Bronze	E84426_16S_SZ_G3	6	144.500
		16A 2 Gang Kotak Kontak Tipe Schuko, Silver Bronze	E84T426_16S_SZ_G3	4	172.000
		16A 1 Gang Kotak Kontak Internasional, Silver Bronze	E8442616TS_C15426B	8	199.700
		13A 1 Gang Kotak Kontak dengan Sakelar, Neon, Silver Bronze	E8415N_SZ	8	250.400
USB CHARGER		1 x 2.1A USB Charger, SZ	E8431USB_SZ	8	683.300
		2 x 2.1A USB Charger, SZ	E8432USB_SZ	8	1.274.300
PLAT PENUTUP		1 Gang Plat Penutup, Silver Bronze	E8430X_SZ	12	61.700
FRAME GRID PLATE		Frame Tepi Reguler dengan konektor	E8403_36S_SZ	16	59.600
KOTAK KONTAK TV, TELEPON DAN DATA		1 Gang Kotak Kontak Soket TV, Master, Silver Bronze	E8431TVM_SZ	8	350.300
		1 Gang Kotak Kontak RJ11 4 Kawat Telepon Dengan Penutup, Silver Bronze	E8431RJS4_SZ	8	205.000
		1 Gang Kotak Kontak RJ45 Data Outlet Cat 5E, Silver Bronze	E8431RJ_5_SZ	8	448.500
		1 Gang Kotak Kontak RJ45 Data Outlet Cat 6, Silver Bronze	E8431RJ_6_SZ	8	406.500
PEREDUP LAMPU		1 Gang 350VA, 50Hz Peredup Lampu (Dimmer) Datar Universal LED, Silver Bronze	E8431EPD4_SZ	6	1.494.700
AKSESORI HOTEL		Electronic Key Card Time Delay SW	E8431EKT_SZ	6	1.013.900
		2G Full-Flat SW w/DND & PCU Symbols	E8432DMS_SZ	8	359.000
		1G Full-Flat Bell SW w/DND & PCU Symbols	E8431BPDM_SZ	8	346.200
		Universal Shaver Unit, Vertical	E84T727V_SZ	1	1.131.900



Pieno

Kombinasi sempurna antara estetika dan performa



SS Mechanism Switch

Sudut sakelar hanya 3 derajat, menghasilkan suara yang halus dan mengurangi resiko terjadinya loncatan api listrik.

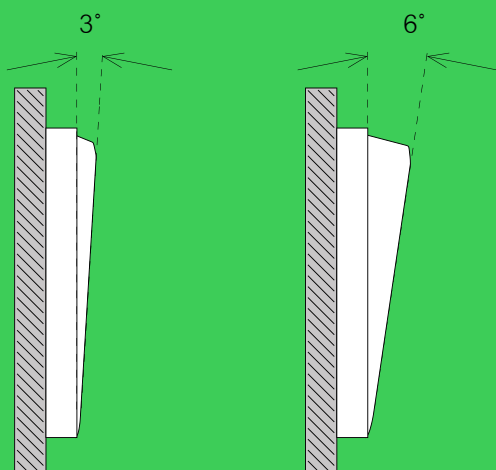

SS Mechanism

Rocker konvensional



PerfectFace
SWITCH ARCHITECTURE







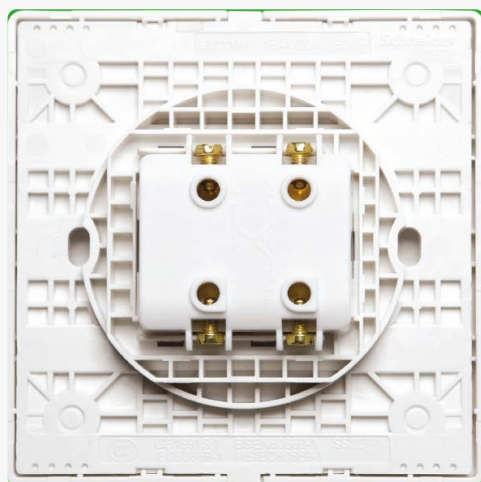















PerfectFace® Switch Architecture







Penutup permukaan sakelar yang berguna untuk menjaga tampilan produk tetap sempurna saat proses pengecatan dinding.



Desain bagian belakang sakelar dirancang berbentuk lingkaran untuk memudahkan pemasangan pada dinding kayu dan furnitur

Jenis	Gambar	Keterangan	Referensi	Pak	Harga (Sebelum PPN)
SAKELAR		16AX 250V Sakelar 1 Gang 1 Arah, Fluoresen, Putih	E8231L1F_WE_G3	8	51.500
		16AX 250V Sakelar 1 Gang 2 Arah, Fluoresen, Putih	E8231L2F_WE_G3	8	55.700
		16AX 250V Sakelar 2 Gang 1 Arah, Fluoresen, Putih	E8232L1F_WE_G3	8	81.800
		16AX 250V Sakelar 2 Gang 2 Arah, Fluoresen, Putih	E8232L2F_WE_G3	8	89.200
		16AX 250V Sakelar 3 Gang 1 Arah, Fluoresen, Putih	E8233L1F_WE_G3	6	143.500
		16AX 250V Sakelar 3 Gang 2 Arah, Fluoresen, Putih	E8233L2F_WE_G3	6	148.700
		10AX 250V Sakelar 4 Gang 1 Arah, Fluoresen, Putih	E8234L1F_WE_G3	6	163.400
		16AX 250V Sakelar 4 Gang 2 Arah, Fluoresen, Putih	E8234L2F_WE_G3	6	167.500
		16AX 250V Sakelar 1 Gang Sakelar Intermediate, Putih	E8231MF_WE_G3	6	132.800
		10A 250V 1 Gang Sakelar Bel, Putih	E8231BPL1_WE_G1	8	162.000
		10A 250V 1 Gang Sakelar Momentary, Fluoresen, Putih	E8231PRL1F_WE_G3	8	56.300
KOTAK KONTAK		16A 250V 1 Gang Kotak Kontak Tipe Schuko, Putih	E82426_16S_WE_G3	8	70.900
		13A 250V Gang Kotak Kontak dan Sakelar, Neon, Putih	E8215N_WE_G1	8	120.300
USB CHARGER		1 x 2.1A USB Charger, WE	E8231USB_WE	8	494.000
		2 x 2.1A USB Charger, WE	E8232USB_WE	8	979.000
		16A International Socket + 2.1 A USB	E8242616USB_WE	8	520.200
PLAT PENUTUP		1 Gang Plat Penutup, Putih	E8230X_WE_G1	10	32.900
KOTAK KONTAK TV, TELEPON DAN DATA		1 Gang Kotak Kontak TV Soket, 75 Ohm, Putih	E8231TV_WE	8	132.700
		1G TELEPHONE SKT, KS ON ST WALLPLATE	E8231RJS4_WE	8	136.100
		1G RJ45 DATA, CAT5E, KS ON SHU WP	E8231RJS_5_WE	8	119.700
PEREDUP LAMPU		240V 450W UNI DIMMER WITH SW	E8232RD450U_WE_G1	8	771.500
AKSESORI HOTEL		250V 16A ELEC KEY CARD TIME DE	E8231EKT_WE_G1	6	684.400
		115V_240V 20VA UNI SHAVER UNIT	E82T727V_WE_G1	1	798.500

Pieno Warna Lavender Silver

Jenis	Gambar	Keterangan	Referensi	Pak	Harga (Sebelum PPN)
SAKELAR		16AX 250V Sakelar 1 Gang 1 Arah, Fluoresen, Lavender Silver	E8231L1F_LS_G3	8	98.200
		16AX 250V Sakelar 1 Gang 2 Arah, Fluoresen, Lavender Silver	E8231L2F_LS_G3	8	133.800
		16AX 250V Sakelar 2 Gang 1 Arah, Fluoresen, Lavender Silver	E8232L1F_LS_G3	8	110.600
		16AX 250V Sakelar 2 Gang 2 Arah, Fluoresen, Lavender Silver	E8232L2F_LS_G3	8	187.500
		16AX 250V Sakelar 3 Gang 1 Arah, Fluoresen, Lavender Silver	E8233L1F_LS_G3	6	198.400
		16AX 250V Sakelar 3 Gang 2 Arah, Fluoresen, Lavender Silver	E8233L2F_LS_G3	6	250.200
		10AX 250V Sakelar 4 Gang 1 Arah, Fluoresen, Lavender Silver	E8234L1F_LS_G3	6	208.000
		16AX 250V Sakelar 4 Gang 2 Arah, Fluoresen, Lavender Silver	E8234L2F_LS_G3	6	234.600
SAKELAR GANDA		20A 250V 1 Gang Sakelar Ganda Neon, Lavender Silver	E8231D20N_LS_G3	6	156.900
KOTAK KONTAK		16A 250V 1 Gang Kotak Kontak Tipe Schuko, Lavender Silver	E82426_16S_LS_G3	8	116.000
		13A 250V 1 Gang Kotak Kontak dan Sakelar, Neon, Lavender Silver	E8215N_LS_G1	8	174.400
USB CHARGER		1 x 2.1A USB Charger, Lavender Silver	E8231USB_LS	8	544.100
		2 x 2.1A USB Charger, Lavender Silver	E8232USB_LS	8	1.051.600
		16A Int Socket with 2.1A USB, Lavender Silver	E8242616USB_LS	8	585.300
PLAT PENUTUP		1 Gang Plat Penutup, Lavender Silver	E8230X_LS_G1	10	44.300
KOTAK KONTAK TV, TELEPON DAN DATA		1 Gang Kotak Kontak, 75OHM, THROUGH-CNN	E8231TV_LS_G1	8	154.100
		1G TEL SKT, KS ON SHU WP	E8231RJS4_LS_G1	8	221.700
		1G RJ45 DATA, CAT5E, KS ON SHU WP	E8231RJS_5_LS_G1	8	193.800
PEREDUP LAMPU		240V 450W 1 Gang Peredup Lampu (Dimmer) dengan Sakelar, Lavender Silver	E8232RD450U_LS_G1	6	774.400



Vivace

Sakelar Minimalis & Modern



Jenis	Gambar	Keterangan	Referensi	Pak	Harga (Sebelum PPN)
SAKELAR		16AX 250V Sakelar 1 Gang - 1 Arah	KB31_1_WE_G3	8	29.900
		16AX 250V Sakelar 1 Gang - 2 Arah	KB31_WE_G3	8	38.000
		16AX 250V Sakelar 2 Gang - 1 Arah	KB32_1_WE_G3	8	46.900
		16AX 250V Sakelar 2 Gang - 2 Arah	KB32_WE_G3	8	59.400
		16AX 250V Sakelar 3 Gang - 1 Arah	KB33_1_WE_G3	8	69.900
		16AX 250V Sakelar 3 Gang - 2 Arah	KB33_WE_G3	8	74.900
		16AX 250V Sakelar 4 Gang - 1 Arah	KB34S_1_WE_G3	8	111.900
		10AX 250V 1 Gang Sakelar Intermediate	KB31IA_WE	5	105.300
		10A 250V 1 Gang Sakelar Bell	KB31BPB	8	108.800
SAKELAR GANDA		20A 1 Gang Sakelar Ganda Neon	KB31D20NE_WE	8	85.100
KOTAK KONTAK		16A 1 Gang Kotak Kontak Tipe Schuko	KB426_16S_WE_G3	10	44.700
		13A 250V 1 Gang Kotak Kontak Sakelar Neon	KB15N	8	92.600
		13A 250V 1 Gang Kotak Kontak Universal 3 pin	KB413S_C15329	10	57.900
USB CHARGER		1 x 2.1A USB Charger, WE	KB31USB_WE	8	393.600
		2 x 2.1A USB Charger, WE	KB32USB_WE	6	819.400
		16A Int Socket with 2.1A USB, WE	KB42616USB_WE	8	471.700
		21W Type A+C, PD+QC3.0 USB Charger, WE	KB32ACQUSB_WE	8	826.600
PLAT PENUTUP		1 Gang Plat Penutup	KB30_WE	15	28.500
AKSESORI BINGKAI		2 Gang Surround	KB_21_WE	15	21.500
		3 Gang Surround	KB_31_WE	18	25.400
		4 Gang Surround	KB_41_WE	18	40.200
KOTAK KONTAK TV, TELEPON DAN DATA		1 Gang Telepon Outlet Dengan Penutup	KB31TS_WE	10	115.500
		2 Gang Telepon Outlet Dengan Penutup	KB32TS	10	105.200
		1 Gang Kotak Kontak TV	KB31TV-OS	10	111.800
		1 Gang Kotak Kontak Data Cat 5E Dengan Penutup	KB31RJ5E_WE	10	117.800
		1 Gang Kotak Kontak Data Cat 6	KB31RJ6_WE	10	149.800
		1 Gang Telp dengan penutup dan 1 Gang Data Cat 5E	KB32TS_RJ5E	10	209.900
PEREDUP LAMPU		400W 1 Gang Peredup Lampu (Dimmer)	KB31RD400_WE	8	332.900
FAN CONTROL		250VA 3 Gang Pengatur Kecepatan Kipas (Exhaust)	KB31RF250_WE	8	612.600
AKSESORI HOTEL		Hotel Key Card	KB31EKT	6	653.000
		Do Not Disturb & Clean Up Room dengan Bell Press	KB31BD_C_WE	8	155.800
		115/240V Shaver Unit	KBT727V_WE	2	714.000



S-Classic

















Desain Tak Lekang Waktu

- Dipercaya lebih dari 40 tahun
- Kuat dan tahan banting

Clipsal telah diakuisisi oleh
Schneider Electric di tahun 2007



S-Classic

Jenis	Gambar	Keterangan	Referensi	Pak	Harga (Sebelum PPN)
SAKELAR		10AX 250V Sakelar 1 Gang - 1 Arah	E31_1_2AR_WE_G3	10	26.100
		10AX 250V Sakelar 1 Gang - 2 Arah	E31_2_3A_WE_G3	10	32.000
		10AX 250V Sakelar 2 Gang - 1 Arah	E32_1_2AR_WE_G3	10	43.100
		10AX 250V Sakelar 2 Gang - 2 Arah	E32_2_3A_WE_G3	10	51.400
		10AX 250V Sakelar 3 Gang - 1 Arah	E33_1_2AR_WE_G3	10	62.600
		10AX 250V Sakelar 3 Gang - 2 Arah	E33_2_3A_WE_G3	10	70.900
		10AX 250V Sakelar 4 Gang - 1 Arah	E34_1_2AR_WE_G3	10	83.500
		10AX 250V Sakelar 5 Gang - 1 Arah	E35_1_2AR_WE_G3	10	127.800
		10AX 6 Gang 1 Way SWITCH REDESIGN	ET36_1_2AR_WE	5	155.400
KOTAK KONTAK		16A 1 Gang Kotak Kontak Tipe Schuko	E426_16S_WE_G3	10	34.900
		13A 1 Gang Kotak Kontak dengan Sakelar dan Lampu Indikator Neon	E15NR_WE	10	79.000
		Tusuk kontak, Kotak Kontak 13A dengan Neon dan Outbowdoost	E15NR_EP13_E238_B	1	113.000
PLAT PENUTUP		1 Gang Plat Penutup	E31X	20	23.100
KOTAK KONTAK TV, TELEPON DAN DATA		1 Gang Kotak Kontak TV Koaksial, 75 Ohm	E31TV75_WE_G12	10	74.200
		1 Gang 4 Wire Telepon Outlet - Putih	ET01_4_WE	10	72.300
		1 Gang Kotak Kontak Data Cat 5	DCEKYBRWPS1PSWT_WE	10	102.100
		1 Gang Kotak Kontak Data RJ45	DC6KYBRWPS1PSWT_WE	10	106.000



Kavacha

Perlindungan sepanjang waktu





Kavacha bel pintu tahan cuaca, dengan proteksi IP 44, melindungi tamu Anda dari percikan air hujan

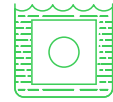

Jaga keluarga Anda dengan Kavacha pelindung sakelar dengan proteksi IP 55

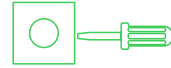



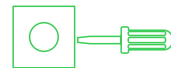

Pastikan area basah di rumah Anda terhindar dari bahaya kesetrum, dengan Kavacha pelindung kontak kontak dengan proteksi IP 55

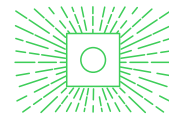
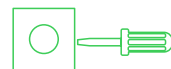

Perlindungan titik listrik di luar rumah Anda terhadap debu dan cuaca dengan Kavacha AS dan Kavacha Isolator Switch IP 56



Kavacha

Gambar	Keterangan	Referensi	Pak	Harga (Sebelum PPN)
	Bel Pintu tahan cuaca dengan indikator LED, IP44, Putih	A3031WBP_WE	1	181.600
	Pelindung kotak kontak tahan cuaca, IP55, Putih	E223R_WE	1	88.200
	Pelindung kotak kontak tahan cuaca, IP55, Transparan	E223R_TR	1	88.200
	20A 250V Surface Mount Single Pole Isolating Switch	WHS20_GY	1	441.600
	35A 250V Surface Mount Single Pole Isolating Switch	WHS35_GY	1	512.600
	55A 250V Surface Mount Single Pole Isolating Switch	WHS55_GY	1	519.100
	20A 440V Surface Mount Double Pole Isolating Switch	WHD20_GY	1	466.300
	35A 440V Surface Mount Double Pole Isolating Switch	WHD35_GY	1	511.800
	55A 440V Surface Mount Double Pole Isolating Switch	WHD55_GY	1	600.800
	63A 440V Surface Mount Double Pole Isolating Switch	WHD63_GY	1	642.200
	20A 440V Surface Mount Triple Pole Isolating Switch	WHT20_GY	1	490.200
	35A 440V Surface Mount Triple Pole Isolating Switch	WHT35_GY	1	565.000
	55A 440V Surface Mount Triple Pole Isolating Switch	WHT55_GY	1	701.100
	63A 440V Surface Mount Triple Pole Isolating Switch	WHT63_GY	1	741.400
	SOCKET SWITCH 13A W-P BS1363.2	CSC313_GY	1	631.100
	13A 250V Surface Mount Single Pole Switched Socket with Neon	CSC313N_GY	1	655.500

Bel Pintu tahan cuaca dengan indikator LED

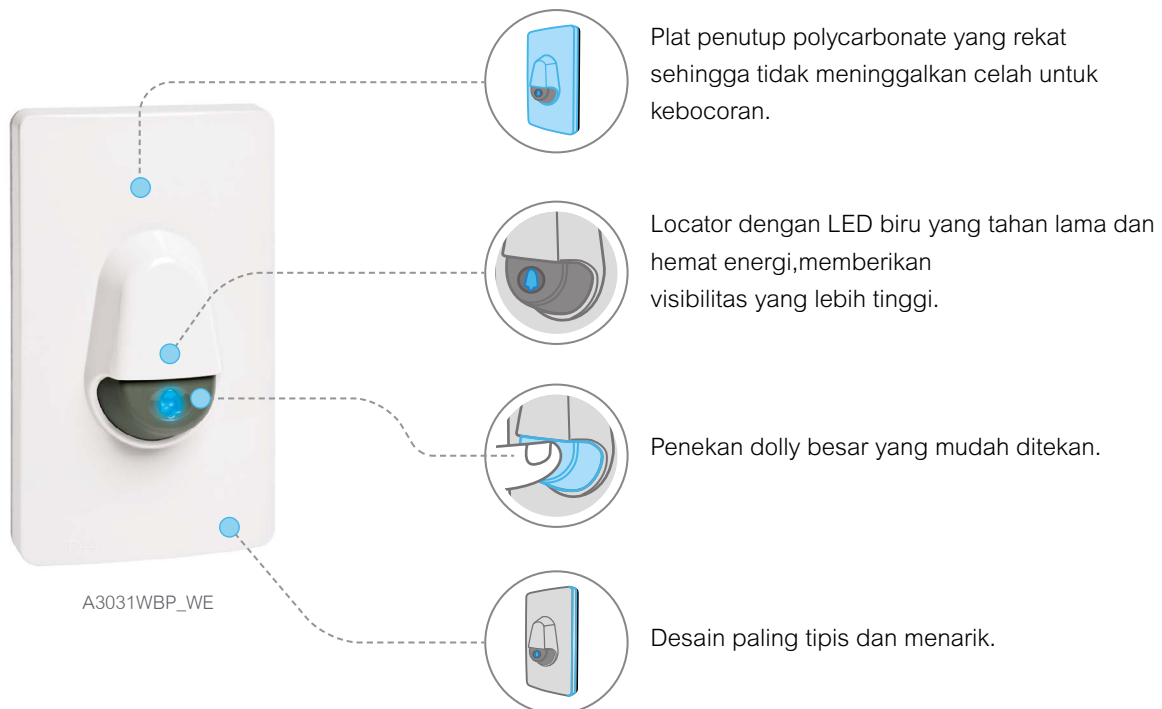

Kavacha Penutup Stop kontak Anti Air dengan Sertifikasi IP 55

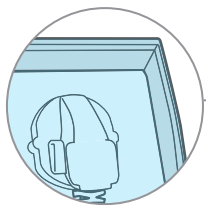

Penutup dengan desain cover yang transparan sehingga tidak mengganggu dekorasi rumah. Terbuat dari bahan polikarbonat yang tangguh dan tidak mudah pecah.

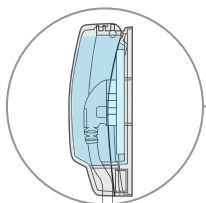

Penutup yang melengkung yang memberikan ruangan yang cukup untuk steker anda, sehingga dapat tetap melindungi titik listrik Anda dari air dan debu walaupun dengan posisi steker terpasang di stop kontak.

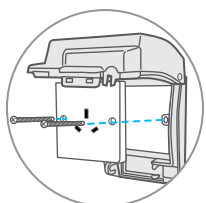

Cocok untuk Stop kontak dengan standar British (BS Standard dengan instalasi sekrup ukuran 86mm x 86mm). Pemasangan mudah dan cepat.

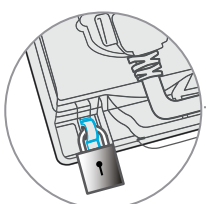

Tersedia pengait gembok untuk pengamanan tambahan.

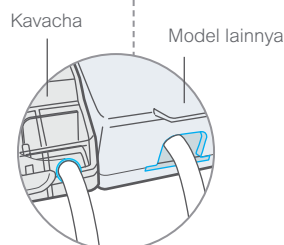

Tersedia jalur kabel dengan ukuran presisi untuk melindungi dengan sempurna dari air dan kelembapan bahkan dengan keadaan steker terpasang, Tidak seperti produk lain yang memberikan rongga cuku besar pada jalur kabelnya.



ARGUS

Occupancy Sensor



Dual Teknologi

Gabungan teknologi Passive Infrared dan Ultrasonic memberikan efisiensi maksimum untuk berbagai aplikasi.

Peredup Otomatis

Cahaya lampu dapat menyesuaikan tingkat terang/gelap cahaya berdasarkan pengaturan Lux (tingkat cahaya).



Deteksi Ultrasonik

+



Deteksi Infra Merah

=



Deteksi Tanpa Kesalahan

Argus Occupancy Sensor

Spesifikasi Produk		Dual-technology sensing	Dual-technology sensing	High-frequency sensing
Referensi		 CCT551011	 CCT551012	 CCT551023
Deskripsi		ARGUS Presence Dual-Tech (PIR & Ultrasonic) – 1 channel	ARGUS Presence Dual-Tech (PIR & Ultrasonic)- 2 channel	ARGUS High Bay Sensor (High Frequency) – 2 channel
Rentang Deteksi (Tinggi Instalasi: 2.5 m)		PIR: 8 m (diameter) US: adjustable up to 10 m x 16 m (oval shape)	PIR: 8 m (diameter) US: adjustable up to 10 m x 16 m (oval shape)	14 m (diameter) 10 m (diameter) at 6 – 10 m height
Beban 1 (Nilai Maksimal)	Lampu Pijar	2.000 W	2.000 W	2.000 W
	Lampu Holagen AC	1.000 W	1.000 W	1.000 W
	Lampu Holagen LV	1.000 VA	1.000 VA	1.000 VA
	Lampu TL	900 VA	900 VA	900 VA
	Lampu Hemat Energi (termasuk CFL dan Lampu PL)	80 VA	80 VA	80 VA
	Lampu LED	100 W	400 W	100 W
	Beban Kapasitif Jumlah maksimal ballast	100 µF	100 µF	100 µF
Beban 2 (Nilai Maksimal)	HVAC		5 A for ≤ 250 VAC, cos = 1 5 A for ≤ 30 VDC 1 A for ≤ 250 VAC, cos = 0,4	5 A for ≤ 250 VAC, cos = 1 5 A for ≤ 30 VDC 1 A for ≤ 250 VAC, cos = 0,4
Tegangan		230 VAC, 500 V 60 Hz	230 VAC, 500 V 60 Hz	230 VAC, 500 V 60 Hz
Harga (Sebelum PPN)		2.222.640	2.617.650	1.770.090

Spesifikasi Produk		Passive Infrared Sensing	Passive Infrared sensing
Referensi		 CCT570005	 CCT570003
Deskripsi		ARGUS Standard mini PIR Sensor	ARGUS Standard 2 Channel PIR Sensor
Rentang Deteksi (Tinggi Instalasi: 2.5 m)		6m (diameter))	7m (diameter)
Beban 1 (Nilai Maksimal)	Lampu Pijar	1.000 W	1.000 W
	Lampu Holagen AC	800 W	900 W
	Lampu Holagen LV	315 W	250 VA
	Lampu TL	250 VA	200 VA
	Lampu Hemat Energi (termasuk CFL dan Lampu PL)	80 VA	80 VA
	Lampu LED	100 W	100 W
	Beban Kapasitif Jumlah maksimal ballast	25 µF	14 µF (10 A)
Beban 2 (Nilai Maksimal)	HVAC	-	5 A for ≤ 250 VAC, cos = 1 5 A for ≤ 30 VDC 1 A for ≤ 250 VAC, cos = 0,4
Tegangan		230 VAC, 500 V 60 Hz	230 VAC, 50 Hz
Harga (Sebelum PPN)		1.010.630	1.066.490









Neo





















Sakelar dan kotak kontak horizontal dengan teknologi LED



NEO Warna Putih (Body Putih, LED Putih)

Jenis	Gambar	Keterangan	Referensi	Pak	Harga (Sebelum PPN)
SAKELAR HORIZONTAL		10A 1 Gang 1 Arah Sakelar Horizontal, LED Putih	E3031H1_EWWW_G3	8	93.700
		10A 1 Gang 2 Arah Sakelar Horizontal, LED Putih	E3031H2_EWWW_G3	8	189.100
		10A 2 Gang 1 Arah Sakelar Horizontal, LED Putih	E3032H1_EWWW_G3	8	150.000
		10A 2 Gang 2 Arah Sakelar Horizontal, LED Putih	E3032H2_EWWW_G3	8	289.600
		10A 3 Gang 1 Arah Sakelar Horizontal, LED Putih	E3033H1_EWWW_G3	8	277.300
SAKELAR VERTIKAL		10A 1 Gang 1 Arah Sakelar Vertikal, LED Putih	E3031V1_EWWW_G3	8	106.000
		10A 1 Gang 2 Arah Sakelar Vertikal, LED Putih	E3031V2_EWWW_G3	8	189.100
		10A 2 Gang 1 Arah Sakelar Vertikal, LED Putih	E3032V1_EWWW_G3	8	150.000
		10A 2 Gang 2 Arah Sakelar Vertikal, LED Putih	E3032V2_EWWW_G3	8	289.600
		10A 3 Gang 1 Arah Sakelar Vertikal, LED Putih	E3033V1_EWWW_G3	8	277.300
KOTAK KONTAK TV, TELEPON DAN DATA		16A 1 Gang Kotak Kontak Tipe Schuko, LED Putih	E3426_16SS_WW_G3	10	110.700
		10A 250V 1 Gang Kotak Kontak Internasional, LED Putih	E3426_10IS_C15426	8	226.600
		13A Kotak Kontak dengan Sakelar, Neon, LED Putih	E3015D_EWWW	8	303.600
		1 Gang Kotak Kontak RJ11 4 Kawat Telepon Outlet, Putih	E3031RJ_WW	8	169.300
		1 Gang Kotak Kontak RJ45 Data Cat5E, Putih	E3031RJ5E_WW	8	151.700
USB CHARGER		1 x 2.1A USB Charger, WW	E3031USB_WW	8	1.031.600
PLAT PENUTUP		1 Gang Plat Penutup, Putih	E3030X_WW	15	73.700
PEREDUP LAMPU		600W 1 Gang Sakelar Peredup Lampu (Dimmer), LED Putih	E3031HD_EWWW	8	1.328.900
AKSESORI HOTEL		Shaver Unti Vertical, White	ET3727V_WW	1	1.218.700

NEO Warna Grey Silver (Body Grey Silver, LED Biru)

Jenis	Gambar	Keterangan	Referensi	Pak	Harga (Sebelum PPN)
SAKELAR HORIZONTAL		10A 1 Gang 1 Arah Sakelar Horizontal, LED Biru, Grey Silver	E3031H1_EBGS_G3	8	137.600
		10A 1 Gang 2 Arah Sakelar Horizontal, LED Biru, Grey Silver	E3031H2_EBGS_G3	8	215.400
		10A 2 Gang 1 Arah Sakelar Horizontal, LED Biru, Grey Silver	E3032H1_EBGS_G3	8	172.600
		10A 2 Gang 2 Arah Sakelar Horizontal, LED Biru, Grey Silver	E3032H2_EBGS_G3	8	323.000
		10A 3 Gang 1 Arah Sakelar Horizontal, LED Biru, Grey Silver	E3033H1_EBGS_G3	8	281.300
		10A 4 Gang 1 Arah Sakelar Horizontal, LED Biru, Grey Silver	E3034H1_EBGS_G3	8	313.000
SAKELAR VERTIKAL		10A 1 Gang 1 Arah Sakelar Vertikal, LED Biru, Grey Silver	E3031V1_EBGS_G3	8	137.600
		10A 1 Gang 2 Arah Sakelar Vertikal, LED Biru, Grey Silver	E3031V2_EBGS_G3	8	215.400
		10A 2 Gang 1 Arah Sakelar Vertikal, LED Biru, Grey Silver	E3032V1_EBGS_G3	8	172.600
		10A 2 Gang 2 Arah Sakelar Vertikal, LED Biru, Grey Silver	E3032V2_EBGS_G3	8	323.000
		10A 3 Gang 1 Arah Sakelar Vertikal, LED Biru, Grey Silver	E3033V1_EBGS_G3	8	318.500
KOTAK KONTAK TV, TELEPON DAN DATA		16A 1 Gang Kotak Kontak Tipe Schuko, Grey Silver	E3426_16SS_GS_G3	10	158.600
		10A 250V 1 Gang Kotak Kontak Internasional, Grey Silver	E3426_10IS_C15426A	8	232.700
		13A Kotak Kontak dengan Sakelar Neon, Grey Silver	E3015D_EBGS	8	278.200
		1 Gang Kotak Kontak RJ11 4 Kawat Telepon Outlet, Grey Silver	E3031RJ_GS	8	193.400
		1 Gang Kotak Kontak RJ45 Data Cat5E, Grey Silver	E3031RJ5E_GS	8	157.800
		1 Gang Kotak Kontak RJ45 Data Cat5E, Grey Silver	E3031RJ5E_GS	8	157.800
USB CHARGER		1 x 2.1A USB Charger, GS	E3031USB_GS	8	778.500
PLAT PENUTUP		1 Gang Plat Penutup, Grey Silver	E3030X_GS	15	82.200
AKSESORI HOTEL		E3000 KEY CARD SWITCH	E3031EKTH_GS	8	1.023.900



Domae Baru, Pilihan Terbaik

Pastikan rumah Anda terlindungi oleh perangkat proteksi arus listrik yang berkualitas.



MCB RCBO RCCB SPD

MCB Domae



MCB melindungi dari :



Beban berlebih



Hubung singkat atau korsleting



Breaking Capacity 6.000A (6kA)

Pada saat terjadi arus pendek (korsleting), arus akan melonjak sangat tinggi. MCB Domae mampu menahan korsleting hingga 6.000A



Daya tahan mekanikal 20.000 kali

MCB Domae Baru memiliki daya tahan mekanikal, atau daya tahan MCB untuk dioperasikan on dan off (toggle klak-klik naik dan turun) TANPA aliran listrik, sebesar 20.000 kali



Daya tahan elektrik 10.000 kali

MCB Domae Baru memiliki daya tahan elektrik, atau daya tahan MCB untuk dioperasikan on dan off (toggle klak-klik naik dan turun) DENGAN aliran listrik, sebesar 10.000 kali



MCB Domae sudah bersertifikat **SNI**



RCCB Domae

Pastikan rumah Anda terlindungi dari kesetrum dengan menggunakan RCCB Domae

RCCB Domae adalah perangkat listrik yang mampu mencegah terjadinya kesetrum terhadap penghuni rumah. Kemampuannya mendeteksi dan mencegah terjadinya kesetrum memberikan rasa aman bagi kita.

* **CATATAN:** Beberapa tukang listrik mengenal produk ini sebagai ELCB.

- RCCB Domae sensitivitas 30mA untuk perlindungan manusia, sensitivitas 300mA untuk perlindungan aset atau mesin
- Pastikan bahwa instalasi listrik rumah Anda sudah terpasang grounding
- Setelah selesai instalasi RCCB Domae, jangan lupa untuk menekan tombol test untuk memeriksa apakah RCCB Domae berfungsi dengan baik.
- Jika setelah di tekan tombol test, tuas/toggle yang berwarna Oranye turun (off), maka RCCB Domae berfungsi dengan baik. Naikkan kembali tuas/toggle ke arah atas (on)

Petunjuk Instalasi RCCB Domae

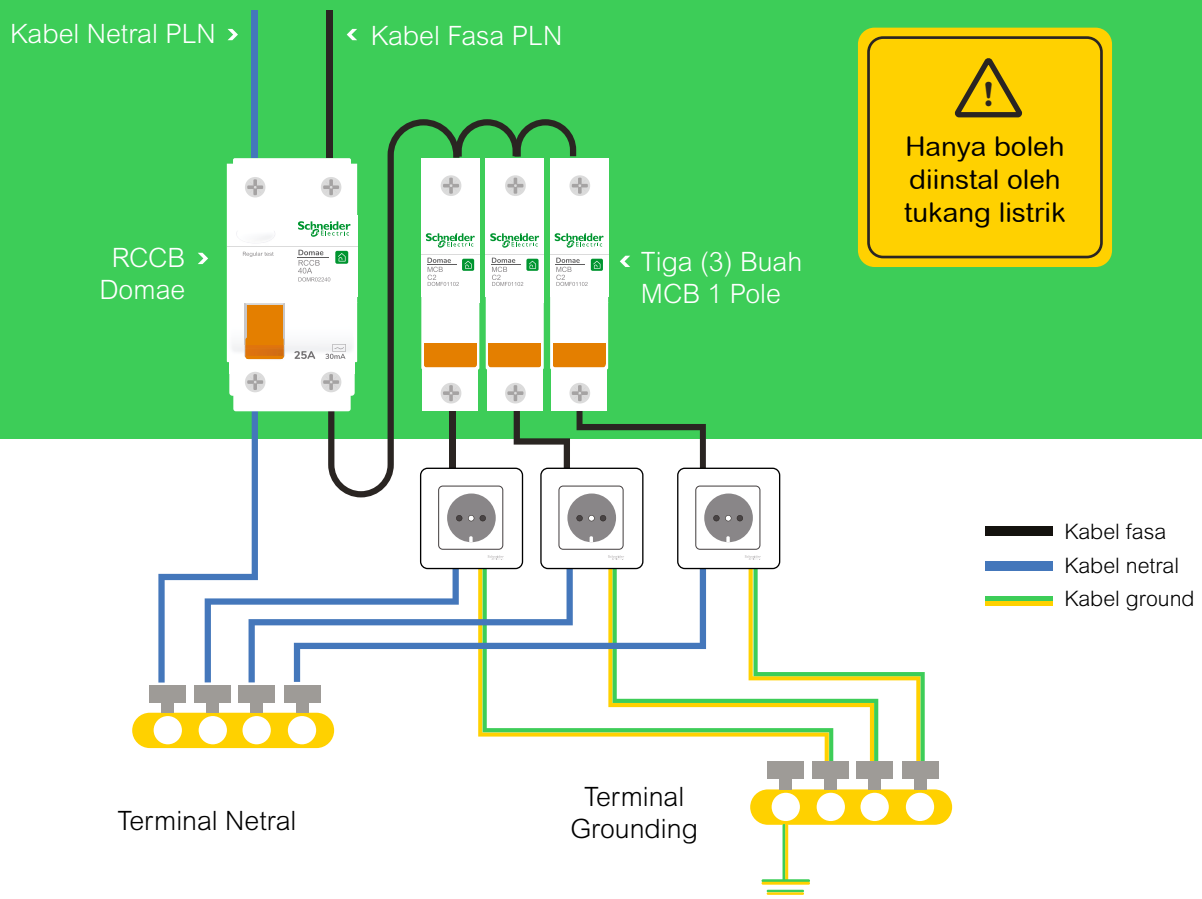



RCBO Slim Domae

RCBO Slim Domae adalah inovasi yang merupakan gabungan Antara MCB dengan RCCB.

Fungsi RCBO Slim Domae



Melindungi dari kesetrum



Melindungi dari korsleting (short circuit)



Melindungi dari beban lebih



Surge arrester (SPD Domae)

Surge Arrester (SPD) Domae adalah perangkat listrik yang melindungi peralatan elektronik terhadap bahaya induksi petir.

Fungsi SPD Domae



Melindungi peralatan elektronik dari bahaya induksi petir

Petunjuk Instalasi RCBO Slim dan SPD Domae

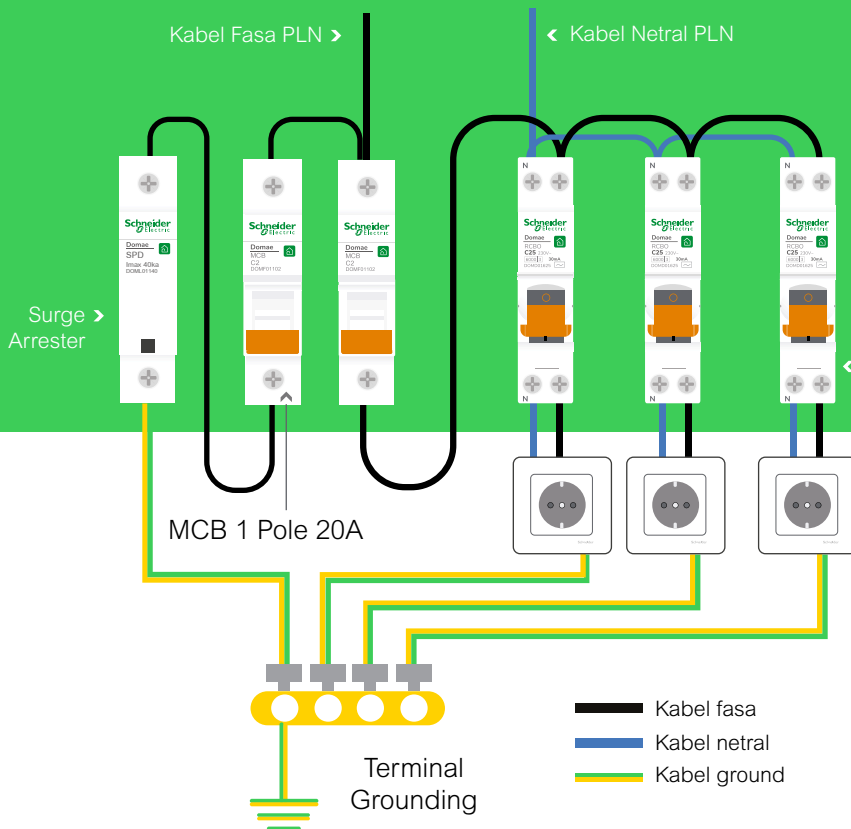

* CATATAN:



Rangkaian ini adalah simulasi instalasi RCBO Slim dan SPD Domae pada satu rangkaian.

1. Untuk instalasi RCBO Slim Domae saja, hilangkan SPD Domae dan MCB Domae 20A
2. Untuk instalasi SPD dan MCB Domae saja, gantikan 3 RCBO Slim Domae dengan 3 MCB Domae.

< Tiga (3) Buah RCBO Slim Domae



MCB Domae



Gambar	Kutub	Rating Arus	Referensi	Pak	Harga (Sebelum PPN)
	1	2	DOMF01102	12	113.500
		4	DOMF01104	12	113.500
		6	DOMF01106	12	91.000
		10	DOMF01110	12	91.000
		16	DOMF01116	12	91.000
		20	DOMF01120	12	91.000
		25	DOMF01125	12	101.000
		32	DOMF01132	12	104.000
		40	DOMF01140	12	127.000
		50	DOMF01150	12	262.000
		63	DOMF01163	12	262.000
	2	2	DOMF01202	6	333.000
		4	DOMF01204	6	333.000
		6	DOMF01206	6	256.000
		10	DOMF01210	6	256.000
		16	DOMF01216	6	256.000
		20	DOMF01220	6	256.000
		25	DOMF01225	6	291.500
		32	DOMF01232	6	304.000
		40	DOMF01240	6	358.500
		63	DOMF01263	6	589.000
	3	6	DOMF01306	6	416.500
		10	DOMF01310	4	416.500
		16	DOMF01316	4	416.500
		20	DOMF01320	4	416.500
		25	DOMF01325	4	449.000
		32	DOMF01332	4	484.500
		40	DOMF01340	4	567.500
		50	DOMF01350	4	937.000
63	DOMF01363	4	937.000		

MCB Box

Gambar	Modul	Tinggi	Lebar	Tebal	Referensi	Harga (Sebelum PPN)
	4	222	136	92	DOMH12104F	117.000
	8	222	208	92	DOMH12108F	166.500
	12	222	280	92	DOMH12112F	211.000

RCBO Slim & ELCB Domae

Gambar	Kutub	Sensitivitas	Rating Arus	Referensi	Pak	Harga (Sebelum PPN)
RCBO Slim						
	1P + N	30 mA	6	DOMD01606	12	766.500
			10	DOMD01610	12	766.500
			16	DOMD01616	12	766.500
			20	DOMD01620	12	766.500
			25	DOMD01625	12	843.000

ELCB							
	1P + N	30 mA	25	DOMR01225	6	691.000	
			40	DOMR01240	6	759.000	
			63	DOMR01263	6	986.500	
			25	DOMR02225	6	725.000	
			300 mA	40	DOMR02240	6	797.000
			63	DOMR02263	6	1.036.000	
	3P + N	30 mA	25	DOMR01425	3	1.036.000	
			40	DOMR01440	3	1.138.500	
			63	DOMR01463	3	1.539.000	
			25	DOMR02425	3	1.087.500	
			300 mA	40	DOMR02440	3	1.243.000
			63	DOMR02463	3	1.553.500	

Surge Arrester

Gambar	Tipe	Referensi	Pak	Harga (Sebelum PPN)
Surge Arrester PF 40kA				
	Domae PF 1P	DOML01140	12	343.500
	Domae PF 1P+N	DOML01640	6	807.500
	Domae PF 3P	DOML01340	3	1.133.500
	Domae PF 3P+N	DOML01740	3	1.459.500

Mini Pragma

Gambar	Baris	Modul (18mm)	Tinggi	Lebar	Tebal	Referensi	Harga (Sebelum PPN)
Transparan (Inbow)							
	1	8	252	222	98	MIP22108S	705.000
	1	12	252	294	98	MIP22112S	601.500
	1	18	252	402	98	MIP22118S	679.000
	2	24	377	294	98	MIP22212S	773.500
	3	36	502	294	98	MIP22312S	1.133.500
Putih (Inbow)							
	1	8	252	222	98	MIP22108	461.000
	1	12	252	294	98	MIP22112	547.500
	1	18	252	402	98	MIP22118	683.500
	2	24	377	294	98	MIP22212	733.500
	3	36	502	294	98	MIP22312	1.000.500

GoPact MCCB

Robust, Simple, Compact, Standalone



- ✓ Arus nominal sampai 800 A
- ✓ Trip unit dilengkapi dengan thermal adjustability
- ✓ Electronic trip unit dari 500 sampai 800 A
- ✓ Seluruh fasa dan netral terlindungi
- ✓ Plug-in base tersedia dari GoPact MCCB 200

Breaking capacity are at 415 V AC

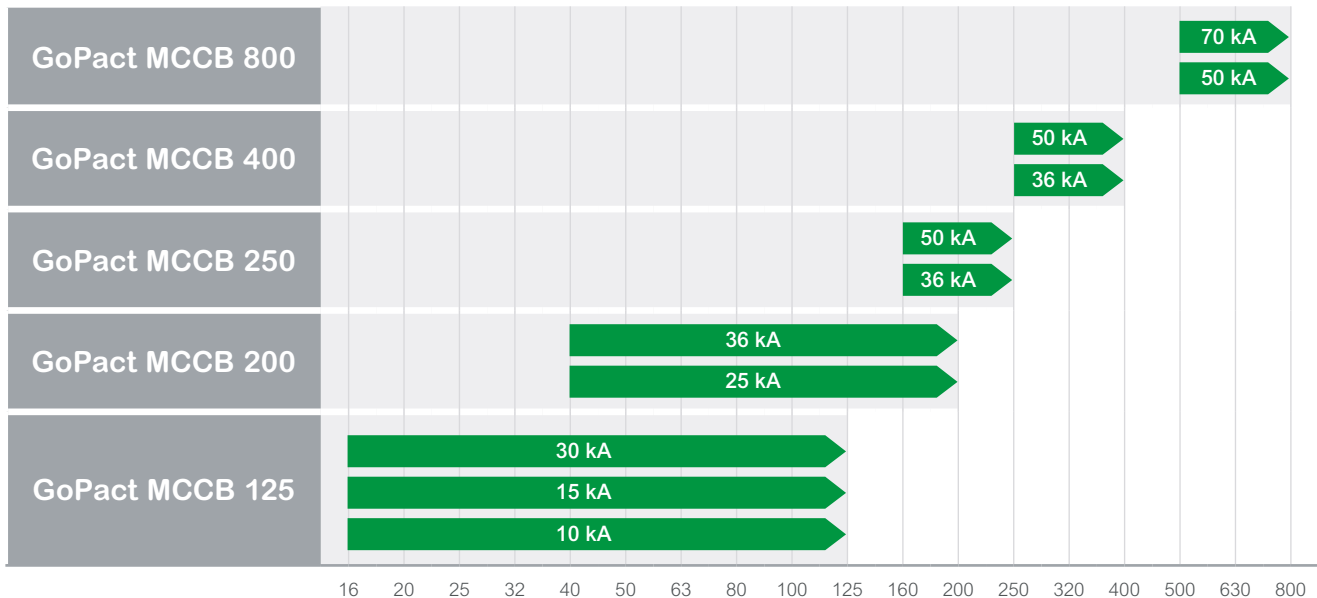

GoPact Molded Case Circuit Breaker 125

With thermal-magnetic trip unit TM-D

Rating	Fixed						Adjustable					
	3P 3D	Harga (Rp) (Sebelum PPN)	SS	4P 4D	Harga (Rp) (Sebelum PPN)	SS	3P 3D	Harga (Rp) (Sebelum PPN)	SS	4P 4D	Harga (Rp) (Sebelum PPN)	SS
Icu = 10 kA at 415 V AC												
16 A	G12T3F16	772.000	1 - MTS	G12T4F16	1.043.000	2 - MTO	G12T3A16	1.103.000	2 - MTO	G12T4A16	1.521.000	2 - MTO
20 A	G12T3F20	772.000	1 - MTS	G12T4F20	1.043.000	2 - MTO	G12T3A20	1.103.000	2 - MTO	G12T4A20	1.521.000	2 - MTO
25 A	G12T3F25	772.000	1 - MTS	G12T4F25	1.043.000	2 - MTO	G12T3A25	1.103.000	2 - MTO	G12T4A25	1.521.000	2 - MTO
32 A	G12T3F32	772.000	1 - MTS	G12T4F32	1.043.000	2 - MTO	G12T3A32	1.103.000	2 - MTO	G12T4A32	1.521.000	2 - MTO
40 A	G12T3F40	772.000	1 - MTS	G12T4F40	1.043.000	2 - MTO	G12T3A40	1.103.000	2 - MTO	G12T4A40	1.521.000	2 - MTO
50 A	G12T3F50	772.000	1 - MTS	G12T4F50	1.043.000	2 - MTO	G12T3A50	1.103.000	2 - MTO	G12T4A50	1.521.000	2 - MTO
63 A	G12T3F63	772.000	1 - MTS	G12T4F63	1.043.000	2 - MTO	G12T3A63	1.103.000	2 - MTO	G12T4A63	1.521.000	2 - MTO
80 A	G12T3F80	772.000	1 - MTS	G12T4F80	1.043.000	2 - MTO	G12T3A80	1.103.000	2 - MTO	G12T4A80	1.521.000	2 - MTO
100 A	G12T3F100	772.000	1 - MTS	G12T4F100	1.043.000	2 - MTO	G12T3A100	1.103.000	2 - MTO	G12T4A100	1.521.000	2 - MTO
125 A	G12T3F125	947.000	1 - MTS	G12T4F125	1.292.000	2 - MTO	G12T3A125	1.275.000	2 - MTO	G12T4A125	1.608.000	2 - MTO
Icu = 15 kA at 415 V AC												
16 A	G12E3F16	818.000	1 - MTS	G12E4F16	1.105.000	2 - MTO	G12E3A16	1.159.000	2 - MTO	G12E4A16	1.573.000	2 - MTO
20 A	G12E3F20	818.000	1 - MTS	G12E4F20	1.105.000	2 - MTO	G12E3A20	1.159.000	2 - MTO	G12E4A20	1.573.000	2 - MTO
25 A	G12E3F25	818.000	1 - MTS	G12E4F25	1.105.000	2 - MTO	G12E3A25	1.159.000	2 - MTO	G12E4A25	1.573.000	2 - MTO
32 A	G12E3F32	818.000	1 - MTS	G12E4F32	1.105.000	2 - MTO	G12E3A32	1.159.000	2 - MTO	G12E4A32	1.573.000	2 - MTO
40 A	G12E3F40	818.000	1 - MTS	G12E4F40	1.105.000	2 - MTO	G12E3A40	1.159.000	2 - MTO	G12E4A40	1.573.000	2 - MTO
50 A	G12E3F50	818.000	1 - MTS	G12E4F50	1.105.000	2 - MTO	G12E3A50	1.159.000	2 - MTO	G12E4A50	1.573.000	2 - MTO
63 A	G12E3F63	818.000	1 - MTS	G12E4F63	1.105.000	2 - MTO	G12E3A63	1.159.000	2 - MTO	G12E4A63	1.573.000	2 - MTO
80 A	G12E3F80	818.000	1 - MTS	G12E4F80	1.105.000	2 - MTO	G12E3A80	1.106.000	2 - MTO	G12E4A80	1.573.000	2 - MTO
100 A	G12E3F100	818.000	1 - MTS	G12E4F100	1.105.000	2 - MTO	G12E3A100	1.106.000	2 - MTO	G12E4A100	1.573.000	2 - MTO
125 A	G12E3F125	1.049.000	1 - MTS	G12E4F125	1.376.000	2 - MTO	G12E3A125	1.411.000	2 - MTO	G12E4A125	1.764.000	2 - MTO
Icu = 30 kA at 415 V AC												
16 A	G12F3F16	1.018.000	1 - MTS	G12F4F16	1.218.000	2 - MTO	G12F3A16	1.227.000	2 - MTO	G12F4A16	1.770.000	2 - MTO
20 A	G12F3F20	1.018.000	1 - MTS	G12F4F20	1.218.000	2 - MTO	G12F3A20	1.227.000	2 - MTO	G12F4A20	1.770.000	2 - MTO
25 A	G12F3F25	1.018.000	1 - MTS	G12F4F25	1.218.000	2 - MTO	G12F3A25	1.227.000	2 - MTO	G12F4A25	1.770.000	2 - MTO
32 A	G12F3F32	1.018.000	1 - MTS	G12F4F32	1.218.000	2 - MTO	G12F3A32	1.227.000	2 - MTO	G12F4A32	1.770.000	2 - MTO
40 A	G12F3F40	1.018.000	1 - MTS	G12F4F40	1.218.000	2 - MTO	G12F3A40	1.227.000	2 - MTO	G12F4A40	1.770.000	2 - MTO
50 A	G12F3F50	1.018.000	1 - MTS	G12F4F50	1.218.000	2 - MTO	G12F3A50	1.227.000	2 - MTO	G12F4A50	1.770.000	2 - MTO
63 A	G12F3F63	1.018.000	1 - MTS	G12F4F63	1.218.000	2 - MTO	G12F3A63	1.227.000	1 - MTS	G12F4A63	1.770.000	2 - MTO
80 A	G12F3F80	1.018.000	1 - MTS	G12F4F80	1.218.000	2 - MTO	G12F3A80	1.227.000	1 - MTS	G12F4A80	1.839.000	2 - MTO
100 A	G12F3F100	1.018.000	1 - MTS	G12F4F100	1.218.000	2 - MTO	G12F3A100	1.227.000	2 - MTO	G12F4A100	1.839.000	2 - MTO
125 A	G12F3F125	1.307.000	2 - MTO	G12F4F125	1.725.000	2 - MTO	G12F3A125	1.527.000	2 - MTO	G12F4A125	2.062.000	2 - MTO



GoPact Molded Case Circuit Breaker 200/250/400

GoPact Molded Case Circuit Breaker 200

With thermal-magnetic trip unit TM-D



Rating	Adjustable					
	3P 3D	Harga (Rp) (Sebelum PPN)	SS	4P 4D	Harga (Rp) (Sebelum PPN)	SS
Icu = 25 kA at 415 V AC						
40 A	G20B3A40	1.503.000	2 - MTO	G20B4A40	1.989.000	2 - MTO
50 A	G20B3A50	1.503.000	2 - MTO	G20B4A50	1.989.000	2 - MTO
63 A	G20B3A63	1.503.000	2 - MTO	G20B4A63	1.989.000	2 - MTO
80 A	G20B3A80	1.503.000	2 - MTO	G20B4A80	1.989.000	2 - MTO
100 A	G20B3A100	1.503.000	1 - MTS	G20B4A100	1.989.000	2 - MTO
125 A	G20B3A125	1.706.000	1 - MTS	G20B4A125	2.279.000	2 - MTO
160 A	G20B3A160	1.791.000	1 - MTS	G20B4A160	2.401.000	2 - MTO
200 A	G20B3A200	1.981.000	1 - MTS	G20B4A200	2.673.000	2 - MTO
Icu = 36 kA at 415 V AC						
40 A	G20F3A40	1.595.000	2 - MTO	G20F4A40	2.162.000	2 - MTO
50 A	G20F3A50	1.595.000	2 - MTO	G20F4A50	2.162.000	2 - MTO
63 A	G20F3A63	1.595.000	2 - MTO	G20F4A63	2.162.000	2 - MTO
80 A	G20F3A80	1.595.000	2 - MTO	G20F4A80	2.162.000	2 - MTO
100 A	G20F3A100	1.595.000	2 - MTO	G20F4A100	2.162.000	2 - MTO
125 A	G20F3A125	1.829.000	1 - MTS	G20F4A125	2.478.000	2 - MTO
160 A	G20F3A160	1.934.000	1 - MTS	G20F4A160	2.864.000	2 - MTO
200 A	G20F3A200	2.153.000	1 - MTS	G20F4A200	3.160.000	2 - MTO

GoPact Molded Case Circuit Breaker 250

With thermal-magnetic trip unit TM-D



Rating	Adjustable					
	3P 3D	Harga (Rp) (Sebelum PPN)	SS	4P 4D	Harga (Rp) (Sebelum PPN)	SS
Icu = 25 kA at 415 V AC						
160 A	G25B3A160	2.299.000	2 - MTO	G25B4A160	3.034.000	2 - MTO
200 A	G25B3A200	2.369.000	2 - MTO	G25B4A200	3.104.000	2 - MTO
250 A	G25B3A250	2.369.000	1 - MTS	G25B4A250	3.104.000	2 - MTO
Icu = 36 kA at 415 V AC						
160 A	G25F3A160	2.499.000	2 - MTO	G25F4A160	3.387.000	2 - MTO
200 A	G25F3A200	2.499.000	2 - MTO	G25F4A200	3.527.000	2 - MTO
250 A	G25F3A250	2.499.000	1 - MTS	G25F4A250	3.527.000	2 - MTO

GoPact Molded Case Circuit Breaker 400

With thermal-magnetic trip unit TM-D



Rating	Adjustable					
	3P 3D	Harga (Rp) (Sebelum PPN)	SS	4P 4D	Harga (Rp) (Sebelum PPN)	SS
Icu = 36 kA at 415 V AC						
250 A	G40F3A250	4.911.000	2 - MTO	G40F4A250	6.629.000	2 - MTO
320 A	G40F3A320	4.911.000	1 - MTS	G40F4A320	6.629.000	2 - MTO
400 A	G40F3A400	4.911.000	1 - MTS	G40F4A400	6.629.000	2 - MTO
Icu = 50 kA at 415 V AC						
250 A	G40N3A250	5.598.000	2 - MTO	G40N4A250	7.557.000	2 - MTO
320 A	G40N3A320	5.598.000	2 - MTO	G40N4A320	7.557.000	2 - MTO
400 A	G40N3A400	5.598.000	2 - MTO	G40N4A400	7.557.000	2 - MTO

GoPact Molded Case Circuit Breaker 800

GoPact Molded Case Circuit Breaker 800



Rating	Adjustable					
	3P 3D	Harga (Rp) (Sebelum PPN)	SS	4P 4D	Harga (Rp) (Sebelum PPN)	SS
Icu = 50 kA at 415 V AC						
500 A	G80N3TM500	8.546.000	2 - MTO	G80N4TM500	11.538.000	2 - MTO
630 A	G80N3TM630	8.546.000	2 - MTO	G80N4TM630	11.538.000	2 - MTO
800 A	G80N3TM800	11.394.000	2 - MTO	G80N4TM800	15.660.000	2 - MTO
Icu = 70 kA at 415 V AC						
500 A	G80H3TM500	9.370.000	2 - MTO	G80H4TM500	12.418.000	2 - MTO
630 A	G80H3TM630	9.370.000	2 - MTO	G80H4TM630	12.418.000	2 - MTO
800 A	G80H3TM800	12.494.000	2 - MTO	G80H4TM800	16.558.000	2 - MTO

GoPact Molded Case Circuit Breaker 800



Rating	Adjustable					
	3P 3D	Harga (Rp) (Sebelum PPN)	SS	4P 4D	Harga (Rp) (Sebelum PPN)	SS
Icu = 50 kA at 415 V AC						
500 A	G80N3E500	11.482.000	2 - MTO	G80N4E500	14.926.000	2 - MTO
630 A	G80N3E630	11.482.000	2 - MTO	G80N4E630	14.926.000	2 - MTO
800 A	G80N3E800	15.308.000	1 - MTS	G80N4E800	22.799.000	2 - MTO
Icu = 70 kA at 415 V AC						
500 A	G80H3E500	12.589.000	2 - MTO	G80H4E500	17.940.000	2 - MTO
630 A	G80H3E630	12.589.000	2 - MTO	G80H4E630	17.940.000	2 - MTO
800 A	G80H3E800	16.785.000	2 - MTO	G80H4E800	26.538.000	2 - MTO

GoPact MCCB Internal Accessories

Voltage release (MN) / Shunt trip (MX)



Rating	Referensi	Harga (Rp) (Sebelum PPN)	SS
GoPact MCCB 125 AC 50/60 Hz			
	MN		
110 V	G12UVR110AC	789.000	2 - MTO
240 V	G12UVR230AC	789.000	1 - MTS
415 V	G12UVR415AC	789.000	2 - MTO

GoPact MCCB 125 AC 50/60Hz			
110-415 V	G12SHT415AC	542.000	2 - MTO

GoPact MCCB 200-250 AC 50/60Hz			
	MN		
110 V	G20-25UVR110AC	902.000	2 - MTO
240 V	G20-25UVR240AC	902.000	1 - MTS
415 V	G20-25UVR415AC	902.000	2 - MTO

GoPact MCCB 200-250 AC/DC 50/60Hz			
	MX		
24 V	G20-25SHT24DC	617.000	2 - MTO
48 V	G20-25SHT48DC	617.000	2 - MTO
110 V	G20-25SHT110AC	617.000	2 - MTO
240 V	G20-25SHT240AC	617.000	1 - MTS
415 V	G20-25SHT415AC	617.000	2 - MTO

GoPact MCCB 400-800 AC/DC 50/60Hz			
	MN		
110 V	G40-80UVR110AC	961.000	2 - MTO
240 V	G40-80UVR240AC	961.000	2 - MTO
415 V	G40-80UVR415AC	961.000	2 - MTO

GoPact MCCB 400-800 AC/DC 50/60Hz			
	MX		
24 V	G40-80SHT24DC	686.000	1 - MTS
48 V	G40-80SHT48DC	689.000	2 - MTO
110 V	G40-80SHT110AC	686.000	2 - MTO
240 V	G40-80SHT240AC	713.000	2 - MTO
415 V	G40-80SHT415AC	720.000	2 - MTO

Auxiliary contact (OF/SD)



Rating	Referensi	Harga (Rp) (Sebelum PPN)	SS
Auxiliary contact (OF/SD) GoPact MCCB 125-250			
240 V	G12-25AUX240	299.000	1 - MTS

Auxiliary contact (OF/SD) GoPact MCCB 400-800			
240 V	G40-80AUX240	334.000	2 - MTO

GoPact MCCB External Accessories

External Accessories



	Referensi	Harga (Rp) (Sebelum PPN)	SS	Referensi	Harga (Rp) (Sebelum PPN)	SS
Rotary Handle	Direct			Extended		
GoPact MCCB 125	G12ROTDS	484.000	2 - MTO	G12ROTE	837.000	2 - MTO
GoPact MCCB 200	G20ROTDS	589.000	2 - MTO	G20ROTE	1.041.000	2 - MTO
GoPact MCCB 250	G25ROTDS	620.000	2 - MTO	G25ROTE	1.095.000	2 - MTO
GoPact MCCB 400	G40ROTDS	957.000	2 - MTO	G40ROTE	1.509.000	2 - MTO
GoPact MCCB 800	G80ROTDS	1.008.000	2 - MTO	G80ROTE	1.588.000	2 - MTO



Interphase barriers set of 2						
GoPact MCCB 125	G12FASB2	50.000	2 - MTO			
GoPact MCCB 200	G20FASB2	55.000	2 - MTO			
GoPact MCCB 250	G25FASB2	74.000	2 - MTO			
GoPact MCCB 400-800	G40-80FASB2	112.000	2 - MTO			
GoPact MCCB 200 Plug In Base Insulator	G20PLUGFASB2	69.000	2 - MTO			



	3P			4P		
Short Terminal shield						
GoPact MCCB 125	G12STSHD3P	121.000	2 - MTO	G12STSHD4P	140.000	2 - MTO
GoPact MCCB 200	G20STSHD3P	131.000	2 - MTO	G20STSHD4P	157.000	2 - MTO
GoPact MCCB 250	G25STSHD3P	176.000	2 - MTO	G25STSHD4P	230.000	2 - MTO
GoPact MCCB 400	G40STSHD3P	185.000	2 - MTO	G40STSHD4P	242.000	2 - MTO
GoPact MCCB 800	G80STSHD3P	277.000	2 - MTO	G80STSHD4P	314.000	2 - MTO



	3P			4P		
Long Terminal shield						
GoPact MCCB 125	G12LTSHD3P	326.000	2 - MTO	G12LTSHD4P	366.000	2 - MTO
GoPact MCCB 200	G20LTSHD3P	344.000	2 - MTO	G20LTSHD4P	423.000	2 - MTO
GoPact MCCB 250	G25LTSHD3P	482.000	2 - MTO	G25LTSHD4P	592.000	2 - MTO
GoPact MCCB 400	G40LTSHD3P	508.000	2 - MTO	G40LTSHD4P	624.000	2 - MTO
GoPact MCCB 800	G80LTSHD3P	660.000	2 - MTO	G80LTSHD4P	810.000	2 - MTO



	3P			4P		
Plug-In Base						
GoPact MCCB 200	G20PBASE3P	2.102.000	2 - MTO	G20PBASE4P	2.724.000	2 - MTO
GoPact MCCB 250	G25PBASE3P	2.492.000	2 - MTO	G25PBASE4P	3.201.000	2 - MTO
GoPact MCCB 400	G40PBASE3P	4.011.000	2 - MTO	G40PBASE4P	4.926.000	2 - MTO
GoPact MCCB 800	G80PBASE3P	11.988.000	2 - MTO	G80PBASE4P	13.940.000	2 - MTO



	3P			4P		
Conversion kit for Plug-in Base						
GoPact MCCB 200	G20PLUGKIT3P	897.000	2 - MTO	G20PLUGKIT4P	1.109.000	2 - MTO
GoPact MCCB 250	G25PLUGKIT3P	1.128.000	2 - MTO	G25PLUGKIT4P	1.433.000	2 - MTO
GoPact MCCB 400	G40PLUGKIT3P	2.856.000	2 - MTO	G40PLUGKIT4P	3.636.000	2 - MTO
GoPact MCCB 800	G80PLUGKIT3P	6.300.000	2 - MTO	G80PLUGKIT4P	7.365.000	2 - MTO



	3P			4P		
Terminal Extension Spreaders						
GoPact MCCB 125	G12SPDR3P	388.000	2 - MTO	G12SPDR4P	517.000	2 - MTO
GoPact MCCB 160-200 A	G20SPDR3P	410.000	2 - MTO	G20SPDR4P	546.000	2 - MTO
GoPact MCCB 250	G25SPDR3P	463.000	2 - MTO	G25SPDR4P	629.000	2 - MTO
GoPact MCCB 400	G40SPDR3P	1.263.000	2 - MTO	G40SPDR4P	1.684.000	2 - MTO
GoPact MCCB 800-630 A	G80SPDR3P630	2.932.000	2 - MTO	G80SPDR4P630	3.378.000	2 - MTO
GoPact MCCB 800-800 A	G80SPDR3P800	3.722.000	2 - MTO	G80SPDR4P800	4.291.000	2 - MTO



	3P			4P		
Terminal Extension Spreaders						
GoPact MCCB 200	G20RC3P	992.000	2 - MTO	G20RC4P	1.421.000	2 - MTO
GoPact MCCB 250	G25RC3P	1.167.000	2 - MTO	G25RC4P	1.671.000	2 - MTO
GoPact MCCB 400	G40RC3P	2.040.000	2 - MTO	G40RC4P	2.808.000	2 - MTO
GoPact MCCB 800	G80RC3P	2.399.000	2 - MTO	G80RC4P	3.451.000	2 - MTO



	3P			4P		
Steel bare cable connectors						
GoPact MCCB 200*	G20SBC3P	345.000	2 - MTO	G20SBC4P	441.000	2 - MTO
GoPact MCCB 250	G25SBC3P	695.000	2 - MTO	G25SBC4P	926.000	2 - MTO
GoPact MCCB 400	G40SBC3P	904.000	2 - MTO	G40SBC4P	1.154.000	2 - MTO

EasyPact™ CVS

Moulded Case Circuit Breaker 100A s/d 250A



EasyPact CVS 100/160/250 B/F/N dengan TMD

- Arus Nominal (In) : 100 A/160 A/250 A
- Kapasitas Pemutusan : B (25), F(36) dan N (50) kA pada 380/415 VAC.
- Ics = 100% Icu.⁽¹⁾
- Trip unit :
 - TMD : Thermal Magnetic (adjustable 0.7 - 1 x In)
Untuk proteksi beban distribusi.
- Fixed type, front connection.
- Memenuhi standar IEC 60947-2.

Trip Unit	Ir (A)	Im (A)	3P	Harga (Rp) (Sebelum PPN)	SS	4P	Harga (Rp) (Sebelum PPN)	SS
EasyPact CVS100-250 B (25 kA)								
TM16D	11.2-16	190	LV510300	1.570.000	1 - MTS	LV510310	2.056.000	1 - MTS
TM25D	17.5-25	300	LV510301	1.570.000	1 - MTS	LV510311	2.056.000	1 - MTS
TM32D	22.4-32	400	LV510302	1.570.000	1 - MTS	LV510312	2.056.000	1 - MTS
TM40D	28-40	500	LV510303	1.570.000	1 - MTS	LV510313	2.056.000	1 - MTS
TM50D	35-50	500	LV510304	1.570.000	1 - MTS	LV510314	2.056.000	1 - MTS
TM63D	44.1-63	500	LV510305	1.570.000	1 - MTS	LV510315	2.234.000	1 - MTS
TM80D	56-80	640	LV510306	1.570.000	1 - MTS	LV510316	2.234.000	1 - MTS
TM100D	70-100	800	LV510307	1.570.000	1 - MTS	LV510317	2.234.000	1 - MTS
TM125D	87.5-125	1250	LV516302	2.248.000	1 - MTS	LV516312	2.925.000	1 - MTS
TM160D	112-160	1250	LV516303	2.611.000	1 - MTS	LV516313	3.396.000	1 - MTS
TM200D	140-200	2000	LV525302	2.921.000	1 - MTS	LV525312	3.664.000	1 - MTS
TM250D	175-250	2500	LV525303	3.005.000	1 - MTS	LV525313	3.771.000	1 - MTS
EasyPact CVS100-250 F (36 kA)								
TM16D	11.2-16	190	LV510330	1.705.000	1 - MTS	LV510340	2.263.000	2 - MTO
TM25D	17.5-25	300	LV510331	1.705.000	1 - MTS	LV510341	2.263.000	2 - MTO
TM32D	22.4-32	400	LV510332	1.705.000	1 - MTS	LV510342	2.263.000	2 - MTO
TM40D	28-40	500	LV510333	1.705.000	1 - MTS	LV510343	2.263.000	2 - MTO
TM50D	35-50	500	LV510334	1.705.000	1 - MTS	LV510344	2.263.000	2 - MTO
TM63D	44.1-63	500	LV510335	1.728.000	1 - MTS	LV510345	2.328.000	1 - MTS
TM80D	56-80	640	LV510336	1.728.000	1 - MTS	LV510346	2.328.000	1 - MTS
TM100D	70-100	800	LV510337	1.728.000	1 - MTS	LV510347	2.328.000	1 - MTS
TM125D	87.5-125	1250	LV516332	2.472.000	1 - MTS	LV516342	2.991.000	2 - MTO
TM160D	112-160	1250	LV516333	2.955.000	1 - MTS	LV516343	3.543.000	2 - MTO
TM200D	140-200	2000	LV525332	3.718.000	1 - MTS	LV525342	4.664.000	2 - MTO
TM250D	175-250	2500	LV525333	3.829.000	1 - MTS	LV525343	4.808.000	1 - MTS
EasyPact CVS100-250 N (50 kA)								
TM16D	11.2-16	190	LV510470	2.400.000	2 - MTO	LV510480	3.233.000	2 - MTO
TM25D	17.5-25	300	LV510471	2.400.000	1 - MTS	LV510481	3.233.000	2 - MTO
TM32D	22.4-32	400	LV510472	2.400.000	1 - MTS	LV510482	3.139.000	2 - MTO
TM40D	28-40	500	LV510473	2.400.000	1 - MTS	LV510483	3.233.000	2 - MTO
TM50D	35-50	500	LV510474	2.400.000	2 - MTO	LV510484	3.233.000	2 - MTO
TM63D	44.1-63	500	LV510475	2.472.000	1 - MTS	LV510485	3.332.000	2 - MTO
TM80D	56-80	640	LV510476	2.472.000	2 - MTO	LV510486	3.235.000	2 - MTO
TM100D	70-100	800	LV510477	2.472.000	1 - MTS	LV510487	3.332.000	2 - MTO
TM125D	87.5-125	1250	LV516462	3.330.000	1 - MTS	LV516467	4.331.000	2 - MTO
TM160D	112-160	1250	LV516463	3.977.000	1 - MTS	LV516468	5.176.000	2 - MTO
TM200D	140-200	2000	LV525452	4.852.000	1 - MTS	LV525457	5.963.000	2 - MTO
TM250D	175-250	2500	LV525453	4.852.000	1 - MTS	LV525458	5.963.000	2 - MTO

Catatan:

(1) Ics = Service Breaking Capacity, Icu = Ultimate Breaking Capacity.

ComPacT NSX

Aksesori EasyPact™ CVS100-630 (exclude 100BS) & ComPacT NSX100-630

Kontak Bantu

Memberikan petunjuk mengenai penyebab terputusnya pemutus tenaga.

- OF : Menunjukkan status circuit breaker, tertutup (ON) atau terbuka (OFF).
- SD : Menunjukkan circuit breaker trip karena beban lebih, hubung singkat, gangguan tanah, bekerjanya voltage release, operasi tombol push-to trip
- SDE : Menunjukkan circuit breaker trip karena beban lebih, hubung singkat, gangguan tanah (Vigi, Micrologic 6).
- SDV : Menunjukkan circuit breaker trip karena adanya gangguan tanah (earth fault).
- SDx : Output module untuk trip unit Micrologic yang menunjukkan indikasi gangguan beban lebih.
- SDTAM : Menunjukkan gangguan beban lebih, kehilangan fase, dll (Micrologic 6 seri M atau proteksi motor).



Auxiliary Contact



SDTAM



SDx



Voltage Release

Tipe	NSX 100-250			NSX 400-630		
	Refer-ensi	Harga (Rp) (Sebelum PPN)	SS	Refer-ensi	Harga (Rp) (Sebelum PPN)	SS
OF/SD/SDE/SDV	29450	570.000	1 - MTS	29450	570.000	1 - MTS
Adaptor SDE untuk trip unit TM / MA / Micrologic 2/1.3M (harus diorder bersama SDE ref. 29450)	LV429451	234.000	1 - MTS	sudah terpasang		
SDx Module	LV429532	3.295.000	2 - MTO	LV429532	3.295.000	2 - MTO
SDTAM 24/415 V AC/DC Indikasi Gangguan Beban Lebih	LV429424	4.183.000	2 - MTO	LV429424	4.183.000	2 - MTO

Tipe	CVS 100-250			CVS 400-630		
	Refer-ensi	Harga (Rp) (Sebelum PPN)	SS	Refer-ensi	Harga (Rp) (Sebelum PPN)	SS
OF/SD/SDE/SDV	29450	570.000	1 - MTS	29450	570.000	1 - MTS
Adaptor SDE untuk trip unit TM / MA / ETS2.3 (harus diorder bersama SDE ref. 29450)	LV429451	234.000	1 - MTS	LV540050	310.000	1 - MTS

Voltage Release

- MN : Under voltage release, mentriapkan circuit breaker saat tegangan kontrol jatuh di bawah batas yang ditentukan (antara 0,35 - 0,7 Un).
- MX : Shunt trip, mentriapkan circuit breaker saat tegangan kontrol mencapai 0,7 Un.

Tegangan Kontrol (V)	MX	Harga (Rp) (Sebelum PPN)	SS	MN	Harga (Rp) (Sebelum PPN)	SS	
AC 50/60 Hz	24	LV429384	1.428.000	2 - MTO			
	110/130	LV429386	1.428.000	2 - MTO	LV429406	1.904.000	2 - MTO
	200/240	LV429387	1.428.000	1 - MTS	LV429407	1.904.000	1 - MTS
	380/415 (50 Hz)	LV429388	1.428.000	2 - MTO	LV429408	1.904.000	2 - MTO
	525 (50 Hz)	LV429389	1.428.000	2 - MTO			
DC	12	LV429382	1.428.000	2 - MTO	LV429402	1.904.000	2 - MTO
	24	LV429390	1.428.000	2 - MTO	LV429410	1.904.000	2 - MTO
	30	LV429391	1.428.000	2 - MTO	LV429411	2.745.000	2 - MTO
	48	LV429392	1.428.000	2 - MTO	LV429412	1.904.000	2 - MTO
	125	LV429393	1.428.000	2 - MTO	LV429413	1.904.000	2 - MTO
	250	LV429394	1.428.000	2 - MTO	LV429414	1.904.000	2 - MTO
MN 220/240 VAC dengan tunda waktu (untuk MN 250 V DC LV429414)				LV429427	4.331.000	2 - MTO	



Industrial Plug Socket

Performa tinggi sesuai dengan standar IEC serta mudah diinstal



Plug & Socket

Gambar	Arus Pengenal	Jumlah Kutub	Tegangan Pengenal	Referensi	Pak	Harga (Sebelum PPN)
Socket Panel IP67						
	16 A	2P + Pe	200 - 250V	PKF16F723	10	252.320
		3P + Pe	380 - 415V	PKF16F734	10	288.330
		3P + N + Pe	380 - 415V	PKF16F735	10	315.210
	32 A	2P + Pe	200 - 250V	PKF32F723	8	372.330
		3P + Pe	380 - 415V	PKF32F734	8	394.070
		3P + N + Pe	380 - 415V	PKF32F735	7	430.500
Plug Wander IP44						
	16 A	2P + Pe	200 - 250V	PKE16M423	10	137.660
		3P + Pe	380 - 415V	PKE16M434	10	151.940
		3P + N + Pe	380 - 415V	PKE16M435	10	186.900
	32 A	2P + Pe	200 - 250V	PKE32M423	10	203.280
		3P + Pe	380 - 415V	PKE32M434	10	213.890
		3P + N + Pe	380 - 415V	PKE32M435	10	245.810
Socket Wander IP44						
	16 A	2P + Pe	200 - 250V	PKF16M423	10	201.500
		3P + Pe	380 - 415V	PKF16M434	10	218.510
		3P + N + Pe	380 - 415V	PKF16M435	10	248.220
	32 A	2P + Pe	200 - 250V	PKF32M423	10	270.270
		3P + Pe	380 - 415V	PKF32M434	10	272.480
		3P + N + Pe	380 - 415V	PKF32M435	8	326.870

IP 44

Gambar	Arus Pengenal	Jumlah Kutub	Tegangan Pengenal	Warna	Referensi	Harga (Sebelum PPN)
 Wall Mounted Socket IP 44	16 A	2P + Pe	200 - 250V	Biru	83104	235.830
		3P + Pe	380 - 415V	Merah	83108	312.010
		3P + N + Pe	380 - 415V	Merah	83109	429.720
	32 A	2P + Pe	200 - 250V	Biru	83116	374.640
		3P + Pe	380 - 415V	Merah	83120	456.860
		3P + N + Pe	380 - 415V	Merah	83121	456.810

IP 67

Gambar	Arus Pengenal	Jumlah Kutub	Tegangan Pengenal	Warna	Referensi	Harga (Sebelum PPN)
 Mobile Plug IP 67	16 A	2P + Pe	200 - 250V	Biru	PKE16M723	274.790
		3P + Pe	380 - 415V	Merah	PKE16M734	298.310
		3P + N + Pe	380 - 415V	Merah	PKE16M735	305.870
	32 A	2P + P	200 - 250V	Biru	PKE32M723	366.240
		3P + Pe	380 - 415V	Merah	PKE32M734	400.890
		3P + N + Pe	380 - 415V	Merah	PKE32M735	430.500

Sakelar S56

Gambar	Arus Pengenal	Jumlah Sakelar	Tegangan Pengenal	Referensi	Pak	Harga (Sebelum PPN)
	10	1	250	S56SW110GY	24	441.578
	20	1	250	S56SW120GY	24	492.017
	32	1	250	S56SW132GY	24	552.107
	20	2	500	S56SW220GY	24	874.477
	10	3	500	S56SW310GY	24	638.316
	20	3	500	S56SW320GY	24	659.206



Easy Tesys

Kontaktor dengan kemampuan beroperasi **1,4 juta kali**

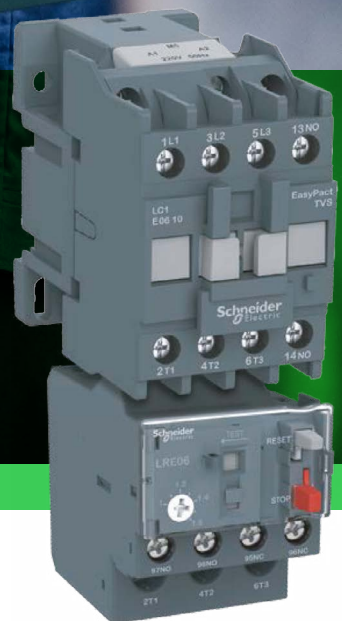

Kontaktor 3 Kutub - Easy TeSys



LC1E06 ●●●●



LC1E65 ●●



LC1E120 ●●



LC1E300 ●●

AC1 (A)	AC3 380/400 V (kW)		AC3 (A)	Kontak Bantu		Referensi	Harga (Sebelum PPN)	
	400 V (kW)	415 V (kW)		N/O	N/C		Koil AC	Koil DC
Koneksi Standar								
20	2.2	2.2	6	1	0	LC1E0610M7		232.000
20	2.2	2.2	6	0	1	LC1E0601M7		232.000
25	4	4	9	1	0	LC1E0910M7		254.000
25	4	4	9	0	1	LC1E0901M7		254.000
25	5.5	5.5	12	1	0	LC1E1210M7		278.000
25	5.5	5.5	12	0	1	LC1E1201M7		278.000
32	7.5	7.5	18	1	0	LC1E1810M7		379.000
32	7.5	7.5	18	0	1	LC1E1801M7		379.000
36	11	11	25	1	0	LC1E2510M7		488.000
36	11	11	25	0	1	LC1E2501M7		488.000
50	15	15	32	1	0	LC1E3210M7		685.000
50	15	15	32	0	1	LC1E3201M7		685.000
50	18.5	18.5	38	1	0	LC1E3810M7		845.000
50	18.5	18.5	38	0	1	LC1E3801M7		845.000
60	18.5	18.5	40	1	1	LC1E40M7		1.149.000
70	22	22	50	1	1	LC1E50M7		1.303.000
80	30	30	65	1	1	LC1E65M7		1.916.000
110	37	37	80	1	1	LC1E80M7		2.053.000
120	45	45	95	1	1	LC1E95M7		2.480.000
150	55	55	120	1	1	LC1E120M5		3.213.000
200	75	75	160	1	1	LC1E160M5		4.254.000
250	90	90	200	-	-	LC1E200M5		8.019.000
300	132	132	250	-	-	LC1E250M5		9.265.000
320	160	160	300	-	-	LC1E300M5		19.615.000
500	200	200	400	-	-	LC1E400M7		25.505.000
700	250	250	500	-	-	LC1E500M7		30.372.000
1000	335	335	630	-	-	LC1E630M7		30.431.000

Catatan: Coil M7 ataupun M5 adalah untuk aplikasi pada 220 V AC. Untuk tipe tegangan coil lainnya silakan hubungi Customer Care Center kami.

Kontaktor 3 Kutub - TeSys Deca



AC1(A)	AC-3 380/415 V		Kontak Bantu		Referensi	Harga (Sebelum PPN)	
	400 V (kW)	415 V (kW)	N/O	N/C		Koil AC	Koil DC
Koneksi Standar							
25	4	9	1	1	LC1D09●●	360.000	1.053.000
25	5.5	12	1	1	LC1D12●●	425.000	1.125.000
32	7.5	18	1	1	LC1D18●●	556.000	1.506.000
40	11	25	1	1	LC1D25●●	760.000	2.035.000
50	15	32	1	1	LC1D32●●	1.034.000	2.940.000
50	18.5	38	1	1	LC1D38●●	1.260.000	3.129.000
Koneksi Everlink							
60	18.5	40	1	1	LC1D40A●●	1.752.000	4.176.000
80	22	50	1	1	LC1D50A●●	2.111.000	4.419.000
80	30	65	1	1	LC1D65A●●	2.948.000	4.785.000

Catatan: Gantikan kode ●● pada referensi untuk tegangan kontrol coil sesuai dengan tabel dibawah.

Koil	220 V AC	24 V AC
Kode	M7	BD



EasyLogic

Power Meter yang Lengkap dan Andal



EasyLogic DM Series & EasyLogic PM2000 Series

Data Teknis

Kelas akurasi : 0.5 untuk Tegangan dan Arus, 0.2 untuk Frekuensi
 Standard : IEC6100042, IEC6100044, IEC6100045, dan IEC60060
 Display : 4 digit LED
 Suhu operasi : 10 C s/d 60 C
 Dimensi : 96 x 96, cutout 92 x 92
 Ratio CT & PT : Adjustable



Fasa	Pengukuran	Operating Range	Referensi	Harga
1	Ampere Meter	50mA-6A	METSEDM1110	550.000
1	Volt Meter	44-480 VAC	METSEDM1210	540.000
1	Frequency Meter	20-100 Hz	METSEDM1310	775.000
3	Ampere Meter	50mA-6A	METSEDM3110	672.000
3	Volt Meter	80-480 VAC L-L	METSEDM3210	622.000

Spesifikasi Umum Power Meter

- Mengukur parameter kelistrikan standar (arus, tegangan, frekuensi, faktor daya, daya, dan energi), dengan kelas akurasi yang baik
- Dilengkapi dengan display LED atau LCD untuk memudahkan pembacaan
- Dimensi : 96 x 96, cutout : 92 x 92
- Adjustable CT & PT Ratio

Spesifikasi	DM6200H	PM2120	PM2220	PM2230
Pengukuran				
• Arus (Fasa dan Netral)	√	√	√	√
• Tegangan (Rata-rata, Fasa-Phasa, dan Fasa-Netral)	√	√	√	√
• Frekuensi	√	√	√	√
• Faktor Daya (Rata-rata dan per Fasa)	√	√	√	√
• Daya (Total dan per Fasa)		√	√	√
• Energi (Aktif, Reaktif, Nyata)		√	√	√
• THD (Arus dan Tegangan)		√	√	√
Kelas Akurasi				
Arus	1	0.5	0.5	0.5
Tegangan	1	0.5	0.5	0.5
Daya Aktif		0.5	0.5	0.5
Daya Reaktif		1	1	1
Energi Aktif		1	1	0.5S
Energi Reaktif		1	1	1
Spesifikasi Lainnya				
LCD	LED 7segment	LED 7segment	Monochrome	Monochrome
Resolusi LCD	-	-	128 x 128	128 x 128
Modbus Serial (RS485)	√	√	√	√

Spesifikasi	Referensi	Harga
Digital Meter Seri 6000H dengan komunikasi	METSEDM6200HCL10RS	1.877.000
Power Meter Seri 2000 LED dengan Komunikasi	METSEPM2120	3.902.000
Power Meter Seri 2000 LCD dengan komunikasi	METSEPM2220	6.039.000
Power Meter Seri 2000 LCD dengan Komunikasi dan Akurasi 0.5S	METSEPM2230	6.391.000





Harmony Push Button & Signaling

Push Button tahan hingga **10 juta kali klik**



Produk Relay Schneider memiliki ketahanan mekanis hingga **100 ribu kali cycle**, serta dilengkapi dengan tombol tes manual dan lampu status LED

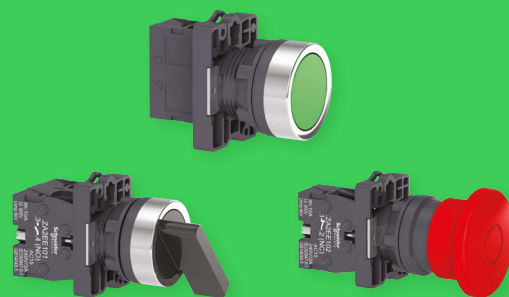

Harmony XB5

- Kualitas standar internasional, indeks proteksi yang tinggi mencapai IP66.
- Sertifikasi lengkap antara lain : IEC, UL, CE, CSA, CCC, NEMA, BV, RINA, GL, dan lain-lain.
- 100.000 jam operasional untuk pilot light dan 10.000.000 kali durabilitas mekanik push button
- Pemasangan yang mudah dan klip metal memastikan push button tidak mudah terlepas.



Harmony XB5, Diameter 22 mm, IP66

Produk	Referensi	Keterangan	Warna	Harga (Sebelum PPN)
Push Button	XB5AA●●	1 N/O (1 N/C untuk merah)	Hitam(21), Hijau(31), Merah(42), Kuning(51), Biru(61)	85.900
Pilot Light	XB5AVM●	230...240V AC	Putih(1), Hijau(3), Merah(4), Jingga(5), Biru(6)	121.500
Selector Switch	XB5AD21	2 Posisi - 1 N/O	Hitam	137.000
Emergency Stop	XB5AS8442	Latching Turn To Release Ø40 mm - 1 N/C	Merah	175.000

Catatan: Gantikan kode ●● dan ● pada referensi dengan kode warna.

Harmony XA2

Kualitas Produk yang OK dengan harga yang Pas

- Performa produk yang dapat diandalkan, IP54 untuk push button dan IP40 untuk pilot light
- Ketahanan dan kualitas yang teruji, standar internasional IEC dan CCC

Mudah dipilih, Mudah digunakan

- Fungsi-fungsi dasar sesuai kebutuhan aplikasi
- Pemasangan yang mudah dan cepat, push button bisa ditambahkan kontak N/O atau N/C

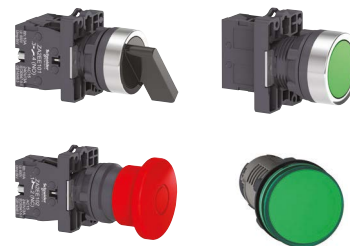

Harmony XA2, Diameter 22 mm, IP54 & IP40

Produk	Referensi	Keterangan	Warna	Harga (Sebelum PPN)
Push Button	XA2EA●●	1 N/O (1 N/C untuk merah)	Putih(11), Hitam(21), Hijau(31), Merah(42), Kuning(51), Biru(61)	45.000
Pilot Light	XA2EVM●LC	220V AC	Putih(1), Hijau(3), Merah(4), Jingga(5), Biru(6)	35.900
Selector Switch	XA2ED21	2 Posisi - 1 N/O	Hitam	60.500
Emergency Stop	XA2ES542	Turn To Release Ø40 mm - 1 N/C	Merah	82.400

Catatan: Gantikan kode ●● dan ● pada referensi dengan kode warna.

ABL2 Switch Mode Power Supplies

- 100 240 input VAC, satu fasa
- Output 24VDC
- 7 opsi daya dalam kisaran 35-350 W
- Rangkaian lengkap sesuai dengan standar EMC
- Sesuai dengan standar CE dan RoHS
- Tegangan output, +/- 10% dapat disesuaikan
- Indikator LED hijau di terminal output
- Produk ini dilengkapi dengan penutup pelindung plastik untuk terminal block sebagai standar.
- Lubang pemasangan yang mudah
- Pemilihan voltase input 115 / 230V AC
- Adaptasi otomatis untuk model 35 / 50W
- Manual dengan sakelar untuk model 100-350W



Tegangan Input (V)	Tegangan Output (V DC)	Daya Nominal (Watt)	Arus Nominal (A)	Filter	Referensi	Harga (Sebelum PPN)
Single-phase (N-L1) atau phase-to-phase (L1-L2)						
AC 100...240 (1) single-phase wide range	24 VDC	35 watt	1.5	Automatic	ABL2REM24015K	416.600
		50 watt	2.2	Automatic	ABL2REM24020K	465.400
		100 watt	4.5	Manual	ABL2REM24045K	611.700
		150 watt	6.5	Manual	ABL2REM24065K	691.200
AC 100...120 AC 200...240 (2) single-phase	24 VDC	200 watt	8.3	Manual	ABL2REM24085K	977.400
		250 watt	10.5	Manual	ABL2REM24100K	1.118.300
		350 watt	14.6	Manual	ABL2REM24150K	1.178.800

Aksesori Mounting

Deskripsi	Untuk Power Supply	Pak	Referensi	Harga (Sebelum PPN)
Braket Instalasi empat pojokan	Direkomendasikan untuk Baut M4*6mm atau M4*8mm	40	ABL2K01	Hub Kami
35MM Braket utk DIN Rail 35mm	ABL2REM24085K/100K/150K: tiap produk butuh 4	5	ABL2K02	Hub Kami
	ABL2REM24200K/250K/350K butuh 2			

Relay

RXM-AB

• Miniatur Relay

Dilengkapi tombol tes manual

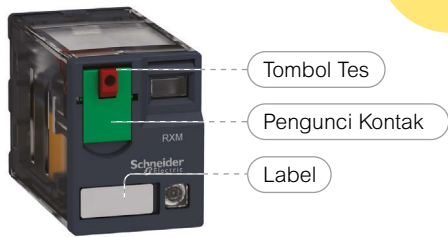

RXM-LB

• Miniatur Relay

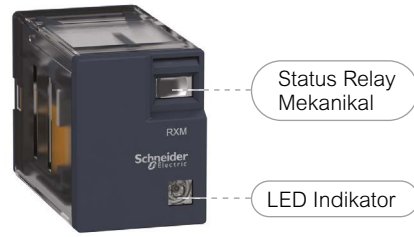

- Bentuk lebih ringkas
- Kemudahan dalam pemasangan/ penggantian 1 to 1 replacement.
- Tersedia 2/4 kontak CO, 24 VDC & 220 VAC

Referensi	Jumlah Pin	Jumlah Kontak (CO)	Arus	LED	Harga (Sebelum PPN)
RXM2AB1●●	8	2	12	-	124.500
RXM2AB2●●	8	2	12	Ya	140.000
RXM4AB1●●	14	4	6	-	116.500
RXM4AB2●●	14	4	6	Ya	140.000

Catatan: Gantikan kode ●● pada referensi untuk tegangan kontrol koil sesuai tabel dibawah.

Koil	24 V DC	230 V AC
Kode ●●	BD	P7

- Untuk tipe tegangan koil lainnya silakan menghubungi customer care center kami.
- Dilengkapi dengan tombol tes manual.

Referensi	Jumlah Pin	Jumlah Kontak (CO)	Arus	LED	Harga (Sebelum PPN)
RXM2LB1●●	8	2	5	-	71.700
RXM2LB2●●	8	2	5	Ya	74.400
RXM4LB1●●	14	4	3	-	82.400
RXM4LB2●●	14	4	3	Ya	88.300

Catatan: Gantikan kode ●● pada referensi untuk tegangan kontrol koil sesuai tabel dibawah.

Koil	24 V DC	230 V AC
Kode ●●	BD	P7

- Untuk tipe tegangan koil lainnya silakan menghubungi customer care center kami.
- Dilengkapi dengan tombol tes manual

RXM-AB

• Socket

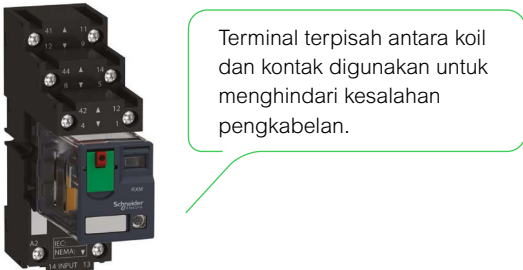

RXM-LB

• Socket



Logic style socket separated termination

Referensi	Untuk Tipe Relay	Terminal	Koneksi	Harga (Sebelum PPN)
RXZE2S108M	RXM2	Terpisah	Konektor	57.300
RXZE2S114M	RXM4	Terpisah	Konektor	64.800

Referensi	Untuk Tipe Relay	Terminal	Koneksi	Harga (Sebelum PPN)
RXZE1M2C	RXM2LB	Tercampur	Screw Clamp	40.700
RXZE1M4C	RXM4LB	Tercampur	Connector	49.800



Medan

UNIPLAZA Building, East Tower, Lt 3
Jl. Letjend. M.T. Haryono A-1
Medan - 20231
Ph. (62) (061) 457 9006
Fax. (62) (061) 455 5153

Batam

Batamindo Industrial Park
Jl. Beringin Blok 4
Muka Kuning, Batam Island - 29433
Ph. (62) (0770) 611 133
Fax. (62) (0770) 611 134

Balikpapan

Komplek Ruko Little China Blok AB 6 No 7,
Balikpapan Baru Balikpapan 76114,
Kalimantan Timur
Ph. (0542)-876722
Fax.(0542)-873709

Head Office Jakarta

Gedung Cibis Nine Park, 16th Floor
Jalan TB Simatupang No. 2,
Cilandak Timur, Jakarta Selatan
DKI Jakarta - 12560
Ph. (021) 5096 6000

APC By Schneider Electric

Gedung Cibis Nine Park, 16th Floor
Jalan TB Simatupang No. 2,
Cilandak Timur, Jakarta Selatan
DKI Jakarta - 12560
Ph. (021) 5096 6000

Surabaya

Gedung Graha Pena Lt. 3 Ruang 302
Jl. Jendral A. Yani no 88, Surabaya 60234
Ph. (62) (031) 8288333 (Hunting)
Fax. (62) (031) 8299901

Cikarang

East Jakarta Industrial Park (EJIP)
Plot 4B no.1-2, Lemah Abang
Bekasi 17550, Jawa Barat
Ph. (62) (21) 897 0203-8
Fax. (62) (21) 897 0209, 897 0085



Scan this QR
Code for our
partner location



Sales Office



Factory

CUSTOMER CARE CENTER

Sejak tahun 1999, PT Schneider Indonesia sangat menyadari pentingnya peranan Customer Care Center dalam menunjang dan meningkatkan pelayanan kepuasan pelanggan seiring dengan visi perusahaan.

Customer care center secara terus menerus mengembangkan dan meningkatkan kemampuan para karyawannya serta perangkat lunak dan perangkat keras sehingga kami dapat melayani seluruh pelanggan di wilayah nusantara.

Unduh aplikasi **mySchneider** dengan QR code scanning. Silakan akses aplikasi untuk:

- Informasi stock barang
- Informasi umum tentang produk
- Informasi harga



PELAYANAN

- Informasi Status Pesanan Barang
- Spesifikasi Produk
- Aplikasi Teknik
- Online Trouble Shooting
- Keluhan Pelanggan



Life Is On

Schneider
Electric

Hotline

1500055

F. (+62) (21) 750 4415-16

E. customercare.id@se.com

se.com/id